

# Altivar Soft Starter ATS430

## Soft Starter for Asynchronous Motors

### User Manual

PKR63392.03  
01/2026



ماكان كنترول

## Legal Information

The information provided in this document contains general descriptions, technical characteristics and/or recommendations related to products/solutions.

This document is not intended as a substitute for a detailed study or operational and site-specific development or schematic plan. It is not to be used for determining suitability or reliability of the products/solutions for specific user applications. It is the duty of any such user to perform or have any professional expert of its choice (integrator, specifier or the like) perform the appropriate and comprehensive risk analysis, evaluation and testing of the products/solutions with respect to the relevant specific application or use thereof.

The Schneider Electric brand and any trademarks of Schneider Electric SE and its subsidiaries referred to in this document are the property of Schneider Electric SE or its subsidiaries. All other brands may be trademarks of their respective owner.

This document and its content are protected under applicable copyright laws and provided for informative use only. No part of this document may be reproduced or transmitted in any form or by any means (electronic, mechanical, photocopying, recording, or otherwise), for any purpose, without the prior written permission of Schneider Electric.

Schneider Electric does not grant any right or license for commercial use of the document or its content, except for a non-exclusive and personal license to consult it on an "as is" basis.

Schneider Electric reserves the right to make changes or updates with respect to or in the content of this document or the format thereof, at any time without notice.

**To the extent permitted by applicable law, no responsibility or liability is assumed by Schneider Electric and its subsidiaries for any errors or omissions in the informational content of this document, as well as any non-intended use or misuse of the content thereof.**

ماكان كنترول

# Table of Contents

Safety Information.....	7
About The Document .....	9
Software Enhancements.....	17
Technical Data for Designers .....	18
Major Characteristics .....	19
Connection In line.....	21
ATS430 and Motor Combination .....	22
Dimensions .....	23
Mounting Position .....	29
Enclosure Thermal Design .....	30
IP20 kits.....	33
Application Diagrams.....	34
Type of coordination .....	36
Control Block Wiring Diagram .....	37
Control Terminal Characteristics .....	38
RUN and STOP Management .....	41
Relay Contacts Wiring .....	43
Software and Tools .....	46
Cybersecurity Generalities .....	47
Inspect, Store and Handle the Product.....	58
Inspecting the Product .....	59
Storage and Shipping .....	60
Weight And Lifting Lugs Availability .....	62
Unpacking and Hoisting on Pallet.....	63
Installation.....	65
Electronic product data sheet .....	66
Mounting the ATS430 .....	67
Installing Door Mounting Kit.....	69
Wiring.....	70
Wiring the Power Part for ATS430D17S6...ATS430C11S6 .....	73
Wiring the Power Part for ATS430C14S6...ATS430C59S6 .....	75
Wiring the Control Terminals .....	78
Checking Installation.....	81
Product HMI .....	83
Front Product LEDs .....	84
Display Terminals .....	85
Configure the display terminal .....	89
Commissioning.....	100
First Power-Up .....	101
Define Parameter visibility .....	106
Define Favorite Parameters List.....	109
Main Menu Presentation .....	110
Simply Start .....	111
Monitoring Settings.....	117
Other Settings .....	134
Small Motor Test.....	138
Torque / Voltage Control.....	140

Start and Stop .....	142
Motor Preheating .....	143
Smoke Extraction .....	148
Voltage Boost.....	150
Functions Compatibility Table .....	151
Command Channel.....	152
Input/Output Assignment.....	156
<b>Configuration Files Management .....</b>	<b>164</b>
Soft Starter Configuration files .....	165
Save & Restore a device configuration .....	166
Save & Restore a device image .....	167
Reset to Factory Settings .....	168
Proceed with a Manufacturer Factory settings .....	168
Proceed with a User-Defined Factory settings .....	169
Product Restart .....	170
Soft starter firmware update .....	171
Display Terminal Language Update .....	174
<b>Cybersecurity operating .....</b>	<b>175</b>
Overview .....	176
Login .....	177
Logout .....	178
Account Management .....	179
Password.....	181
PIN Code.....	183
Admin Credentials Recovery .....	184
Upgrades Management.....	185
Save & Restore a Security Policy .....	186
Port Hardening .....	187
Security Functionality Verification.....	188
Clear Device / Secure Decommissioning .....	190
<b>Communication .....</b>	<b>191</b>
Modbus VP12S port configuration.....	192
Modbus Network Diagnostics .....	196
Device Name .....	198
<b>Monitor the displayed values .....</b>	<b>199</b>
Monitor current measurements .....	200
Monitor voltage measurements .....	201
Monitor power measurements .....	202
Monitor other measurements .....	203
Monitor thermal measurements .....	204
Counter Management .....	205
Other States .....	206
Input & Output Map.....	207
Energy parameters .....	208
<b>Diagnostics and Troubleshooting .....</b>	<b>209</b>
Front Product LEDs .....	210
Diagnostic Data .....	211
Error History .....	213
Warnings .....	215
Fan diagnostic.....	216

Fan status .....	216
Fan diagnostics test .....	217
Fan Counter Reset.....	217
Error and Warning Handling .....	218
Security Event Logging .....	221
Troubleshooting .....	223
Warning messages and error codes .....	225
<b>Maintenance .....</b>	<b>245</b>
Scheduled Servicing .....	246
Real Time Clock (RTC) .....	251
Define a service message .....	252
Decommissioning .....	253
Additional Support .....	254
<b>Annex.....</b>	<b>256</b>
How to interpret and react to a NST state.....	257
How to determine which units are applicable for your soft starter? .....	258
Soft Starter State .....	259
HMI Tree Navigation .....	260
<b>Glossary .....</b>	<b>272</b>

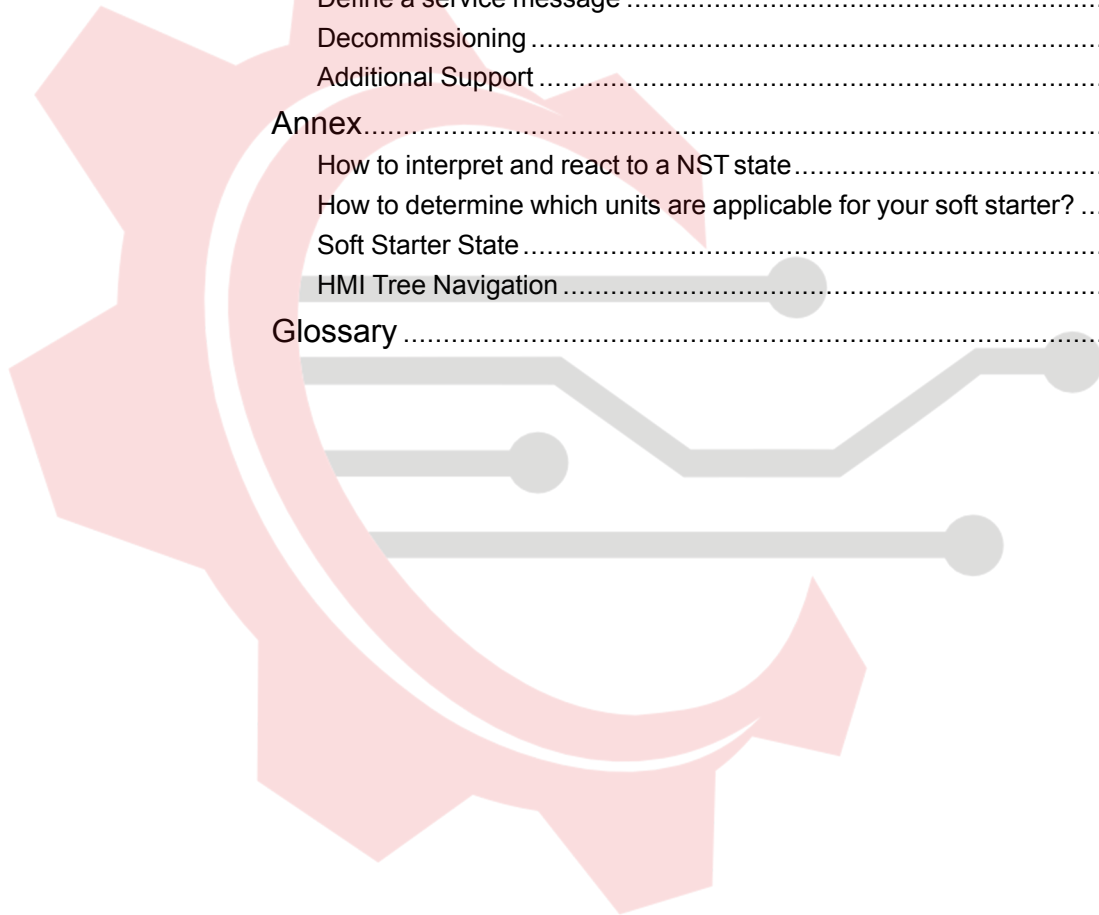

# ماکان کنترول



ماكان كنترول

# Safety Information

## Important Information

Read these instructions carefully, and look at the equipment to become familiar with the device before trying to install, operate, service, or maintain it. The following special messages may appear throughout this documentation or on the equipment to warn of potential hazards or to call attention to information that clarifies or simplifies a procedure.



The addition of this symbol to a “Danger” or “Warning” safety label indicates that an electrical hazard exists which will result in personal injury if the instructions are not followed.



This is the safety alert symbol. It is used to alert you to potential personal injury hazards. Obey all safety messages that follow this symbol to avoid possible injury or death.

### **DANGER**

**DANGER** indicates a hazardous situation which, if not avoided, **will result in death or serious injury**.

### **WARNING**

**WARNING** indicates a hazardous situation which, if not avoided, **could result in death or serious injury**.

### **CAUTION**

**CAUTION** indicates a hazardous situation which, if not avoided, **could result in minor or moderate injury**.

### **NOTICE**

**NOTICE** is used to address practices not related to physical injury.

## Please Note

Electrical equipment should be installed, operated, serviced, and maintained only by qualified personnel. No responsibility is assumed by Schneider Electric for any consequences arising out of the use of this material.

A qualified person is one who has skills and knowledge related to the construction and operation of electrical equipment and its installation, and has received safety training to recognize and avoid the hazards involved.

## Qualification of Personnel

Only appropriately trained persons who are familiar with and understand the contents of this manual and all other pertinent product documentation are authorized to work on and with this product. In addition, these persons must have received safety training to recognize and avoid hazards involved. These persons must have sufficient technical training, knowledge and experience and be able to foresee and detect potential hazards that may be caused by using the product, by changing the settings and by the mechanical, electrical and electronic equipment of the entire system in which the product is used. All persons working on and with the product must be fully familiar with all applicable standards, directives, and accident prevention regulations when performing such work.

## Intended Use

This product is intended for industrial use according to this manual.

The product may only be used in compliance with all applicable safety standard and local regulations and directives, the specified requirements and the technical data. The product must be installed outside the hazardous ATEX zone. Prior to using the product, you must perform a risk assessment in view of the planned application. Based on the results, the appropriate safety measures must be implemented. Since the product is used as a component in an entire system, you must ensure the safety of persons by means of the design of this entire system (for example, machine design). Any use other than the use explicitly permitted is prohibited and can result in hazards.

ماکان کنترول

# About The Document

## Document scope

The purpose of this document is:

- to give mechanical and electrical information related to the Altivar Soft Starter ATS430.
- to show how to install, wire and program this soft starter.

## Validity note

Original instructions and information given in the present document have been written in English (before optional translation).

**NOTE:** The products listed in the document are not all available at the time of publication of this document online. The data, illustrations and product specifications listed in the guide will be completed and updated as the product availabilities evolve. Updates to the guide will be available for download once products are released onto the market.

This documentation is valid only for ATS430.

The characteristics that are presented in this manual should be the same as those characteristics that appear online. In line with our policy of constant improvement, we may revise content over time to improve clarity and accuracy. If you see a difference between the manual and online information, use the online information as your reference.

## Product related information

**Read and understand these instructions before performing any procedure with this soft starter.**

### **DANGER**

#### **HAZARD OF ELECTRIC SHOCK, EXPLOSION, OR ARC FLASH**

- Only appropriately trained persons who are familiar with and fully understand the contents of the present manual and all other pertinent product documentation and who have received all necessary training to recognize and avoid hazards involved are authorized to work on and with this equipment.
- Installation, adjustment, repair and maintenance must be performed by qualified personnel.
- Verify compliance with all local and national electrical code requirements as well as all other applicable regulations with respect to grounding of all equipment.
- Only use properly rated, electrically insulated tools and measuring equipment.
- Do not touch unshielded components or terminals with voltage present.
- Prior to performing any type of work on the equipment, block the motor shaft to prevent rotation.
- Insulate both ends of unused conductors of the motor cable.

**Failure to follow these instructions will result in death or serious injury.**

**⚡⚠ DANGER**

**HAZARD OF ELECTRIC SHOCK, EXPLOSION, OR ARC FLASH**

Before performing work on the equipment:

- Use all required personal protective equipment (PPE).
- Disconnect all power, including external control power that may be present. Take into account that the circuit breaker or main switch does not de-energize all circuits.
- Place a "Do Not Turn On" label on all power switches related to the equipment.
- Lock all power switches in the open position.
- Verify the absence of voltage using a properly rated voltage sensing device.

Before applying voltage to the equipment:

- Verify that the work has been completed and that the entire installation cannot cause hazards.
- If the mains input terminals and the motor output terminals have been grounded and short-circuited, remove the ground and the short circuits on the mains input terminals and the motor output terminals.
- Verify proper grounding of all equipment.
- Verify that all protective equipment such as covers, doors, grids is installed and/or closed.

**Failure to follow these instructions will result in death or serious injury.**

**⚡⚠ DANGER**

**HAZARD OF ELECTRIC SHOCK, EXPLOSION, OR ARC FLASH**

- Never operate energized switch with door open.
- Turn off switch before removing or installing fuses or making load side connections.
- Do not use renewable link fuses in fused switches.

**Failure to follow these instructions will result in death or serious injury.**

Damaged products or accessories may cause electric shock or unanticipated equipment operation.

**⚡⚠ DANGER**

**ELECTRIC SHOCK OR UNANTICIPATED EQUIPMENT OPERATION**

Do not use damaged products or accessories.

**Failure to follow these instructions will result in death or serious injury.**

Contact your local Schneider Electric sales office if you detect any damage whatsoever.

This equipment has been designed to operate outside of any hazardous location. Only install this equipment in zones known to be free of a hazardous atmosphere.

**⚠ DANGER**

**POTENTIAL FOR EXPLOSION**

Install and use this equipment in non-hazardous locations only.

**Failure to follow these instructions will result in death or serious injury.**

Your application consists of a whole range of different interrelated mechanical, electrical, and electronic components, the device being just one part of the application. The device by itself is neither intended to nor capable of providing the entire functionality to meet all safety-related requirements that apply to your application. Depending on the application and the corresponding risk assessment to be conducted by you, a whole variety of additional equipment is required such as, but not limited to, external monitoring devices, guards, etc.

As a designer/manufacturer of machines, you must be familiar with and observe all standards that apply to your machine. You must conduct a risk assessment and determine the appropriate Performance Level (PL) and/or Safety Integrity Level (SIL) and design and build your machine in compliance with all applicable standards. In doing so, you must consider the interrelation of all components of the machine. In addition, you must provide instructions for use that enable the user of your machine to perform any type of work on and with the machine such as operation and maintenance in a safe manner.

The present document assumes that you are fully aware of all normative standards and requirements that apply to your application. Since the device cannot provide all safety-related functionality for your entire application, you must ensure that the required Performance Level and/or Safety Integrity Level is reached by installing all necessary additional equipment.

## **▲ WARNING**

### **INSUFFICIENT PERFORMANCE LEVEL/SAFETY INTEGRITY LEVEL AND/OR UNINTENDED EQUIPMENT OPERATION**

- Conduct a risk assessment according to EN ISO 12100 and all other standards that apply to your application.
- Use redundant components and/or control paths for all critical control functions identified in your risk assessment.
- Verify that the service life of all individual components used in your application is sufficient for the intended service life of your overall application.
- Perform extensive commissioning tests for all potential error situations to verify the effectiveness of the safety-related functions and monitoring functions implemented, for example, but not limited to, speed monitoring by means of encoders, short circuit monitoring for all connected equipment, correct operation of brakes and guards.
- Perform extensive commissioning tests for all potential error situations to verify that the load can be brought to a safe stop under all conditions.

**Failure to follow these instructions can result in death, serious injury, or equipment damage.**

Product may perform unexpected movements because of incorrect wiring, incorrect settings, incorrect data or other errors.

## **▲ WARNING**

### **UNANTICIPATED EQUIPMENT OPERATION**

- Carefully install the wiring in accordance with the EMC requirements.
- Do not operate the product with unknown or unsuitable settings or data.
- Perform a comprehensive commissioning test.

**Failure to follow these instructions can result in death, serious injury, or equipment damage.**

### **⚠ WARNING**

#### **LOSS OF CONTROL**

- The designer of any control scheme must consider the potential failure modes of control paths and, for critical control functions, provide a means to achieve a safe state during and after a path failure. Examples of critical control functions are emergency stop, overtravel stop, power outage and restart.
- Separate or redundant control paths must be provided for critical control functions.
- System control paths may include communication links. Consideration must be given to the implications of unanticipated transmission delays or failures of the link.
- Observe all accident prevention regulations and local safety guidelines (1).
- Each implementation of the product must be individually and thoroughly tested for proper operation before being placed into service.

**Failure to follow these instructions can result in death, serious injury, or equipment damage.**

(1) For USA: Additional information, refer to NEMA ICS 1.1 (latest edition), Safety Guidelines for the Application, Installation and Maintenance of Solid State Control.

Machines, controllers, and related equipment are usually integrated into networks. Unauthorized persons and malware may gain access to the machine as well as to other devices on the network/fieldbus of the machine and connected networks via insufficiently secure access to software and networks.

### **⚠ WARNING**

#### **UNAUTHORIZED ACCESS TO THE MACHINE VIA SOFTWARE AND NETWORKS**

- In your hazard and risk analysis, consider all hazards that result from access to and operation on the network/fieldbus and develop an appropriate cybersecurity concept.
- Verify that the hardware infrastructure and the software infrastructure into which the machine is integrated as well as all organizational measures and rules covering access to this infrastructure consider the results of the hazard and risk analysis and are implemented according to best practices and standards covering IT security and cybersecurity (such as: ISO/IEC 27000 series, Common Criteria for Information Technology Security Evaluation, ISO/IEC 15408, IEC 62351, ISA/IEC 62443, NIST Cybersecurity Framework, Information Security Forum - Standard of Good Practice for Information Security, SE recommended Cybersecurity Best Practices\*).
- Verify the effectiveness of your IT security and cybersecurity systems using appropriate, proven methods.

**Failure to follow these instructions can result in death, serious injury, or equipment damage.**

(\*) : SE Recommended Cybersecurity Best Practices can be downloaded on SE.com.

### **⚠ WARNING**

#### **LOSS OF CONTROL**

Perform a comprehensive commissioning test to verify that communication monitoring properly detects communication interruptions.

**Failure to follow these instructions can result in death, serious injury, or equipment damage.**

This product meets the EMC requirements according to the standard IEC 60947-4-2. This device has been designed for environment A. Use of this product in a domestic environment (B environment) may cause unwanted radio interference.

## **⚠️⚠️ WARNING**

### **RADIO INTERFERENCE**

- In a domestic environment (B environment), this product may cause radio interference in which case supplementary mitigation measures may be required.

**Failure to follow these instructions can result in death, serious injury, or equipment damage.**

## **NOTICE**

### **DESTRUCTION DUE TO INCORRECT MAINS VOLTAGE**

Before switching on and configuring the product, verify that it is approved for the mains voltage.

**Failure to follow these instructions can result in equipment damage.**

## **General Cybersecurity Information**

In recent years, the growing number of networked machines and production plants has seen a corresponding increase in the potential for cyber threats, such as unauthorized access, data breaches, and operational disruptions. You must, therefore, consider all possible cybersecurity measures to help protect assets and systems against such threats.

To help keep your Schneider Electric products secure and protected, it is in your best interest to implement the cybersecurity best practices as described in the [Cybersecurity Best Practices](#) document.

Schneider Electric provides additional information and assistance:

- [Subscribe to the Schneider Electric security newsletter.](#)
- [Visit the Cybersecurity Support Portal web page to:](#)
  - [Find Security Notifications.](#)
  - [Report vulnerabilities and incidents.](#)
- [Visit the Schneider Electric Cybersecurity and Data Protection Posture web page to:](#)
  - [Access the cybersecurity posture.](#)
  - [Learn more about cybersecurity in the cybersecurity academy.](#)
  - [Explore the cybersecurity services from Schneider Electric.](#)

## Environmental Data

The Environmental Data Program is a framework for how we measure, categorize, and compare the environmental attributes and footprint of our products.

Using a rigorous, fact-based methodology, the program provides environmental data from across the product lifecycle.

Five data categories across the product lifecycle

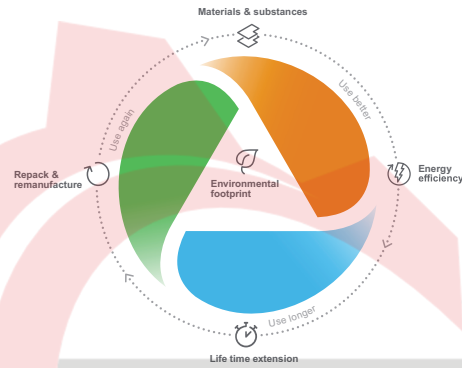

**Use Better:** How sustainable a product is, including environmental footprint, materials and substances, packaging, and energy efficiency.

**Use Longer:** How a product's life time can be effectively extended in terms of reparability and updatability.

**Use Again:** How a product can be reused, from dismantling and remanufacturing to recyclability and manufacturer take back.

With this transparent, verified data, customers and partners are empowered to make conscious environmental choices and accurately evaluate and report on sustainability performance.

All our hardware offers have an associated environmental data available on se.com product pages.

Refer to Environmental Data Program for more information.

## Related Documents

Use your tablet or your PC to quickly access detailed and comprehensive information on all our products on [www.se.com](http://www.se.com) The Internet site provides the information you need for products and solutions:

- The whole catalog for detailed characteristics and selection guides
- The CAD files to help design your installation, available in over 20 different file formats
- All software and firmware to maintain your installation up to date
- A large quantity of White Papers, Environment documents, Application solutions, Specifications... to gain a better understanding of our electrical systems and equipment or automation
- And finally all the User Guides related to your soft starter, listed below:

## Catalog

Title of documentation	Reference number
Catalog: Altivar Soft Starter ATS430	DIA2ED2240602EN (English)
	DIA2ED2240602FR (French)

## Documentations

Title of documentation	Reference number
ATS430 Getting Started	PKR63383 (English), PKR63384 (French) PKR63385 (Spanish), PKR63386 (Italian) PKR63387 (German), PKR63388 (Chinese) PKR63389 (Portuguese), PKR63390 (Turkish)
ATS430 Getting Started Manual Annex for UL	PKR63391 (English)
ATS430 User Manual	PKR63392 (English), PKR63393 (French) PKR63394 (Spanish), PKR63395 (Italian) PKR63396 (German), PKR63397 (Chinese) PKR63398 (Portuguese), PKR63399 (Turkish)
ATS430 Embedded Modbus RTU Manual	PKR63401 (English)
ATS430 Communication Parameter Addresses	PKR63400 (English)
Recommended Cybersecurity Best Practices	CS-Best-Practices-2019-340 (English)

You can download there technical publications and other technical information from our website at [www.se.com/en/download](http://www.se.com/en/download).

## Videos

Title of documentation	Reference number
Video: Getting Started with ATS430	FAQ000263199 (English)

## Software

Title of documentation	Catalog number
SoMove: FDT	SoMove FDT (English, French, German, Spanish, Italian, Chinese)
ATS430: DTM	ATS430 DTM Library EN (English – to be installed first) ATS430 DTM Lang FR (French) ATS430 DTM Lang SP (Spanish) ATS430 DTM Lang IT (Italian) ATS430 DTM Lang DE (German) ATS430 DTM Lang CN (Chinese)

## Terminology

The technical terms, terminology, and the corresponding descriptions in this manual normally use the terms or definitions in the relevant standards.

In the area of soft starters this includes, but is not limited to, terms such as **error**, **error message**, **failure**, **fault**, **fault reset**, **protection**, **safe state**, **safety function**, **warning**, **warning message**, and so on.



Among others, these standards include:

- ISO 13849-1 & 2 Safety of machinery - safety related parts of control systems
- IEC 61158 series: Industrial communication networks - Fieldbus specifications
- IEC 61784 series: Industrial communication networks - Profiles
- IEC 60204-1: Safety of machinery - Electrical equipment of machines – Part 1: General requirements
- IEC 60947–1 Low–Voltage Switchgear and Control Gear – General rules
- IEC 60947–4-2 Semiconductor Motor controllers, Starters and Soft Starters
- IEC 62443: Security for industrial automation and control systems

In addition, the term **zone of operation** is used in conjunction with the description of specific hazards, and is defined as it is for a **hazard zone** or **danger zone** in the EC Machinery Directive (2006/42/EC) and in ISO 12100.

Also see the glossary at the end of this manual.

## Structure of the Parameter Table

Pictogram	Description
	Power cycle must be performed after setting this parameter.
	Read only parameter, mainly used for monitoring.
	Expert mode required to access this parameter.

## Contact us

Select your country on [www.se.com/contact](http://www.se.com/contact).

Schneider Electric Industries SAS

Head Office

35, rue Joseph Monier

92500 Rueil-Malmaison

France

# Software Enhancements

## Overview

**NOTE:** Make sure that the latest version of the software and of the user manual are used.

The Altivar Soft Starter ATS430 will benefit from future software enhancements. Those enhancements will be listed below.

This documentation relates to the version V1.2.

### V1.1 Release Note

Initial release.

### V1.2 Release Note

Labels updated.

ماکان کنترول

# Technical Data for Designers

## What's in This Part

Major Characteristics .....	19
Connection In line .....	21
ATS430 and Motor Combination .....	22
Dimensions .....	23
Mounting Position .....	29
Enclosure Thermal Design .....	30
IP20 kits .....	33
Application Diagrams .....	34
Type of coordination .....	36
Control Block Wiring Diagram .....	37
Control Terminal Characteristics .....	38
RUN and STOP Management .....	41
Relay Contacts Wiring .....	43
Software and Tools .....	46
Cybersecurity Generalities .....	47

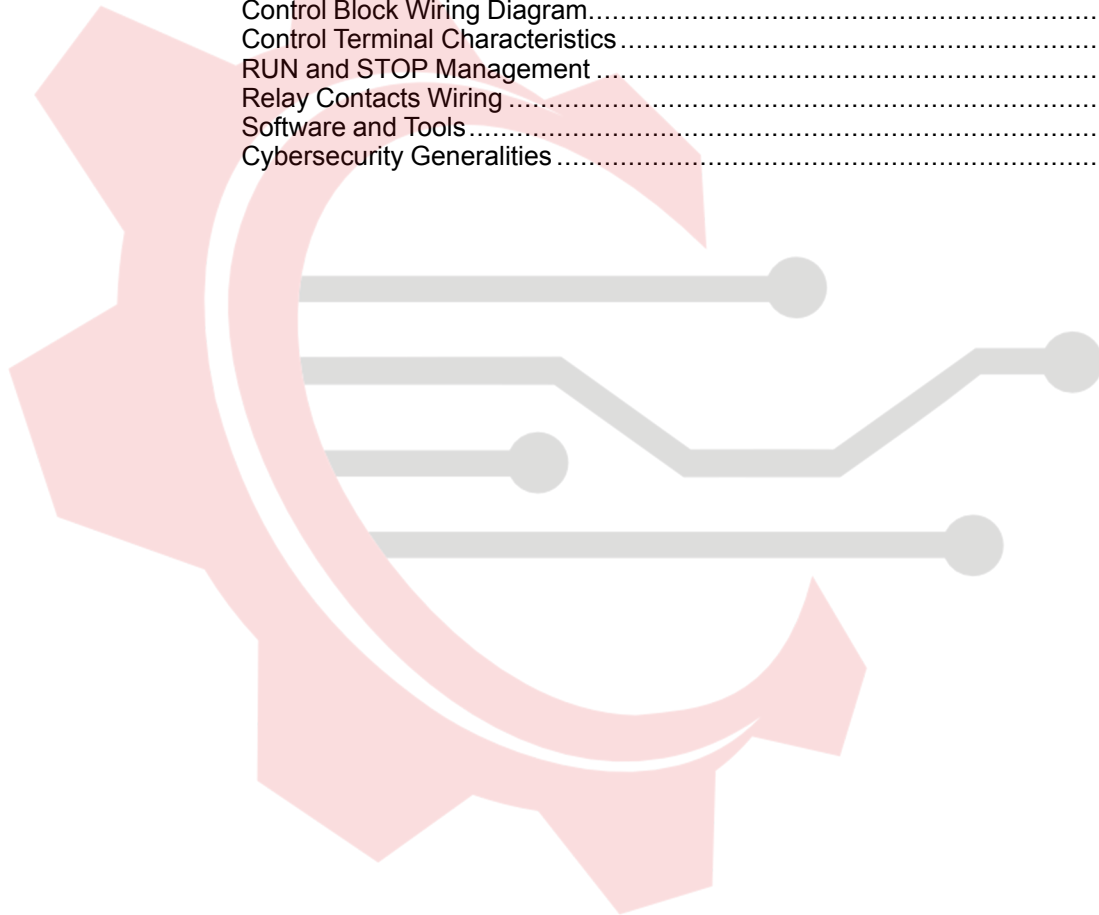

ماکان کنترول

# Major Characteristics

## Electrical Data

<b>Utilization Category</b>	AC-53a : 4-13 : 50-10 (ATS430D17S6....C17S6) 50-6 (ATS430C21S6...C59S6)
<b>Ue Power supply voltage</b>	208...600 Vac
	Tolerance: -15...+10%
<b>Power supply frequency</b>	50...60 Hz
	Tolerance: -20...+20%
<b>Ie Rated operational current</b>	17...590 A
<b>Us control supply voltage</b>	110...230 Vac
	Tolerance: -15...+10%
	50/60 Hz
<b>Current limiting</b>	500% Ie (700% rated motor current)

## Application Data

<b>Application</b>	Normal duty
<b>Torque Control</b>	Yes
<b>Voltage Control</b>	Yes
<b>Controlled stop</b>	Yes
<b>Braking</b>	No
<b>Connection Inside the Delta</b>	No
<b>Bypass</b>	Embedded Bybass

ماکان کنترول

## Environment Data

**NOTE:** The soft starter is designed to be used in a controlled indoor environment.

<b>Degree of protection</b>	IEC 60529	<ul style="list-style-type: none"> <li>IP20 for ATS430D17S6 to C11S6</li> <li>IP00 for ATS430C14S6 to C59S6</li> </ul>	
<b>Vibration resistance</b>	IEC 60068-2-6	<ul style="list-style-type: none"> <li>1.5 mm peak at 2 to 13 Hz</li> <li>10 m/s<sup>2</sup> (1g) at 13 to 200 Hz</li> </ul>	
<b>Shock resistance</b>	IEC 60068-2-27	150 m/s <sup>2</sup> (15 g) during 11 ms	
<b>Maximum ambient pollution degree</b>	IEC 60664-1	Level 3	
<b>Maximum relative humidity</b>	IEC 60068-2-3	5...95% without condensation or dripping water	
<b>Ambient temperature around the unit</b>	-	-25...40 °C (-13...104 °F)	No derating
		up to 60 °C (up to 140 °F)	Derate current by 1% each °C (1.8 °F)
<b>Maximum operating altitude</b>	0...2000m (0...6600ft)	No derating	
	2000...4800m (6600...15700ft)	Derate current by 1% each additional 100m (330ft)	
<b>Operating position</b>	Vertical at ± 10°		

## Mains Supply in Function of the System Earthing Arrangement According to the Altitude

Mains voltage	System earthing arrangement	Supply source overvoltage category required according to altitude (1)	
		Up to 2000 m (6600 ft)	From 2000 m to 4800 m (6600 ft to 15700 ft)
208...480 Vac	TT or TN	OVC III	OVC III
	IT or Corner-Grounded	OVC III	OVC III
480...600 Vac	TT or TN	OVC III	OVC III
	IT or Corner-Grounded	OVC III	OVC III

(1) according to IEC60947-1

The supply source overvoltage category could be reduced by using an appropriate system such as an insulation transformer.

The altitude itself impacts the cooling of the soft starter:

- 0...2000 m (0...6600 ft) without derating of the rated operational current ( $I_e$ ).
- 2000...4800 m (6600...15700 ft) with derating of the rated operational current ( $I_e$ ) of 1% per 100 m (330 ft).

# Connection In line

## Connection In-Line

The soft starter can be connected in-line to the motor supply. The motor connection type (star/delta shown below) depends on the supply mains, refer to the motor nameplate.

- (a): Supply mains
- (b): Soft starter
- (c): Induction motor

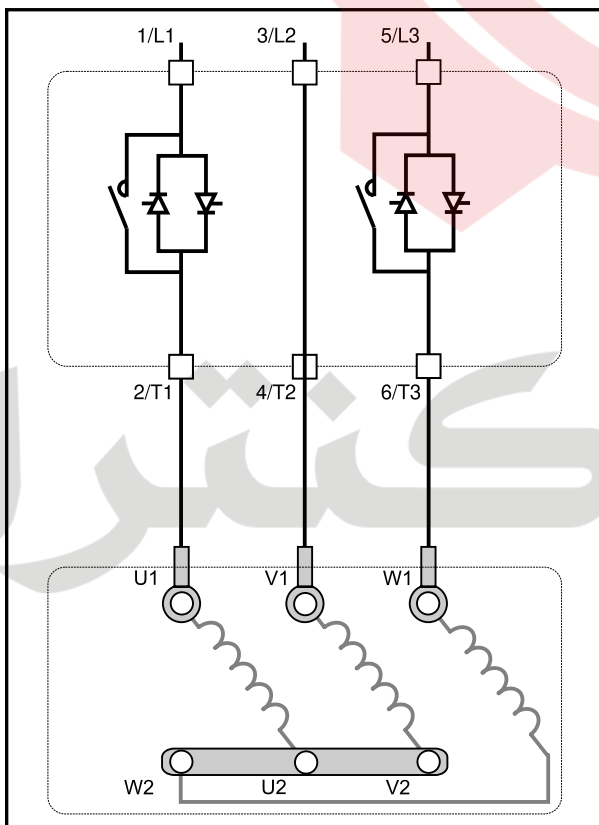
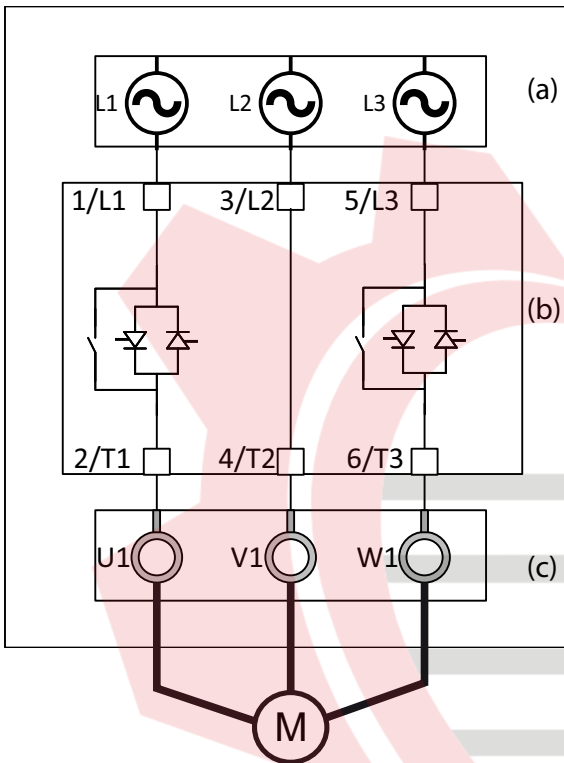

Star connection

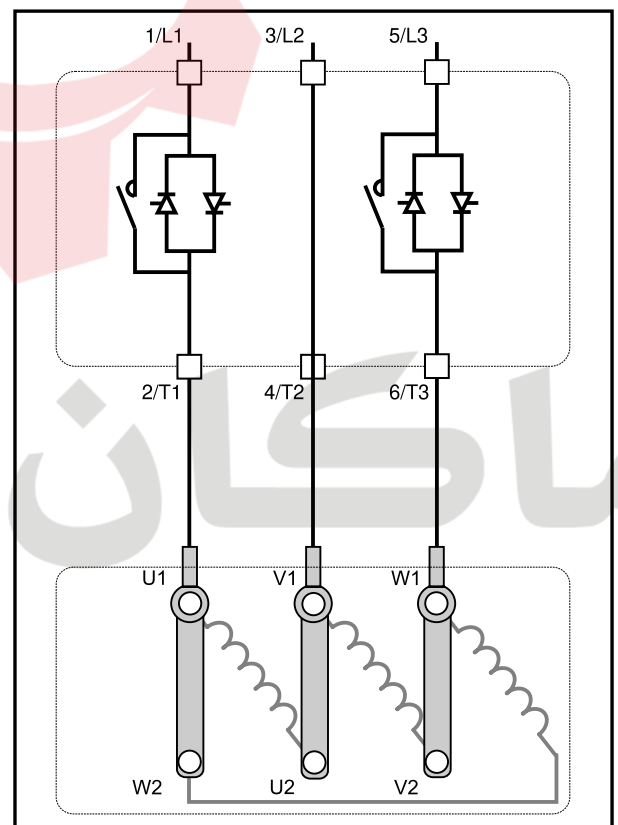

Delta connection

# ATS430 and Motor Combination

## What's in This Chapter

Normal Duty, Soft Starter In Line Connection, 208...600 Vac 50/60 Hz  
Supply ..... 22

## Normal Duty, Soft Starter In Line Connection, 208...600 Vac 50/60 Hz Supply

Motor								Soft starter	
Nominal motor power								Rated operational current I <sub>e</sub> (1)	References
208 Vac	230 Vac		400 Vac	440 Vac	460 Vac	500 Vac	575 Vac		
HP	HP	kW	kW	kW	HP	kW	HP	A	
3	5	4	7.5	7.5	10	9	15	17	ATS430D17S6
7.5	10	7.5	15	15	20	18.5	25	32	ATS430D32S6
—	15	11	22	22	30	30	40	47	ATS430D47S6
15	20	15	30	30	40	37	50	62	ATS430D62S6
20	25	18,5	37	37	50	45	60	75	ATS430D75S6
25	30	22	45	45	60	55	75	88	ATS430D88S6
30	40	30	55	55	75	75	100	110	ATS430C11S6
40	50	37	75	75	100	90	125	140	ATS430C14S6
50	60	45	90	90	125	110	150	170	ATS430C17S6
60	75	55	110	110	150	132	200	210	ATS430C21S6
75	100	75	132	132	200	160	250	250	ATS430C25S6
100	125	90	160	160	250	220	300	320	ATS430C32S6
125	150	110	220	220	300	250	350	410	ATS430C41S6
150	—	132	250	250	350	315	400	480	ATS430C48S6
—	200	160	315	355	400	400	500	590	ATS430C59S6

The nominal motor current I<sub>n</sub> must not exceed the rated operational current I<sub>e</sub>

(1) Current on operation at a maximum ambient temperature of 40 °C (104 °F).  
Above 40 °C (104 °F) and up to an ambient temperature of 60 °C (140 °F), derate  
current by 1% each °C (1.8 °F).

# Dimensions

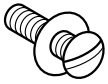

Use screws with DIN 125 washer to mount the soft starter. Tighten the fixing screws.

Altivar Soft Starter ATS430 CAD files can be downloaded from [www.se.com](http://www.se.com).

## ATS430D17S6...ATS430D32S6

### Front, Side and Rear View

Mounting screws x 4: M6

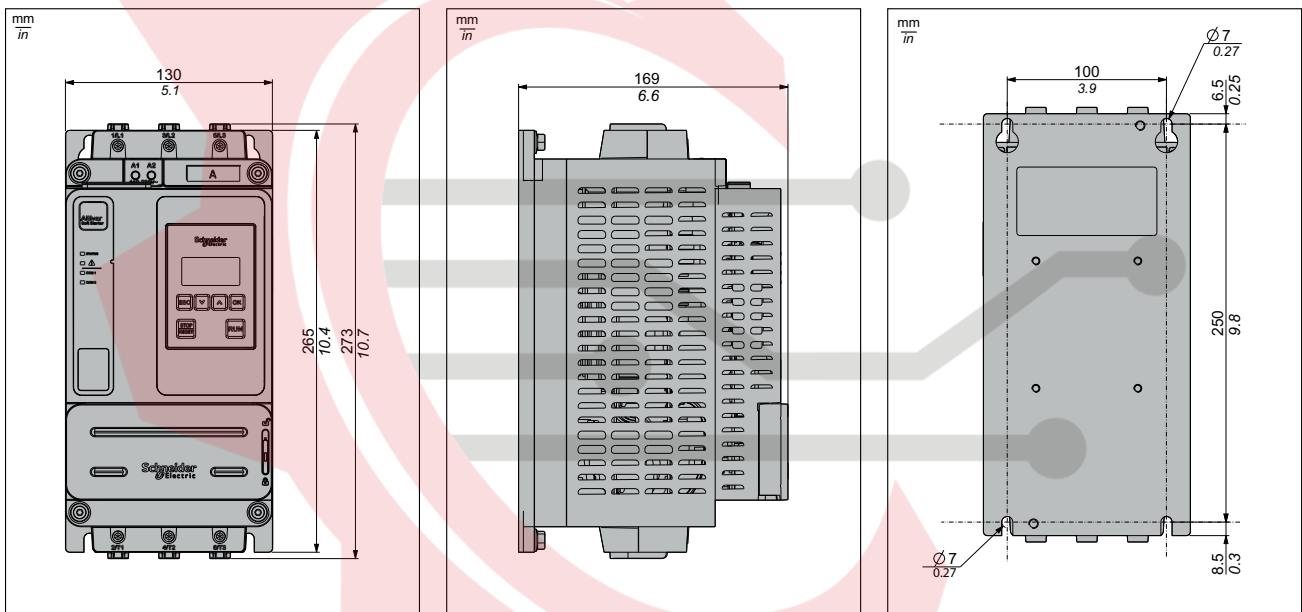

ماکان کنترول

# ATS430D47S6

## Front, Side and Rear View

Mounting screws x 4: M6

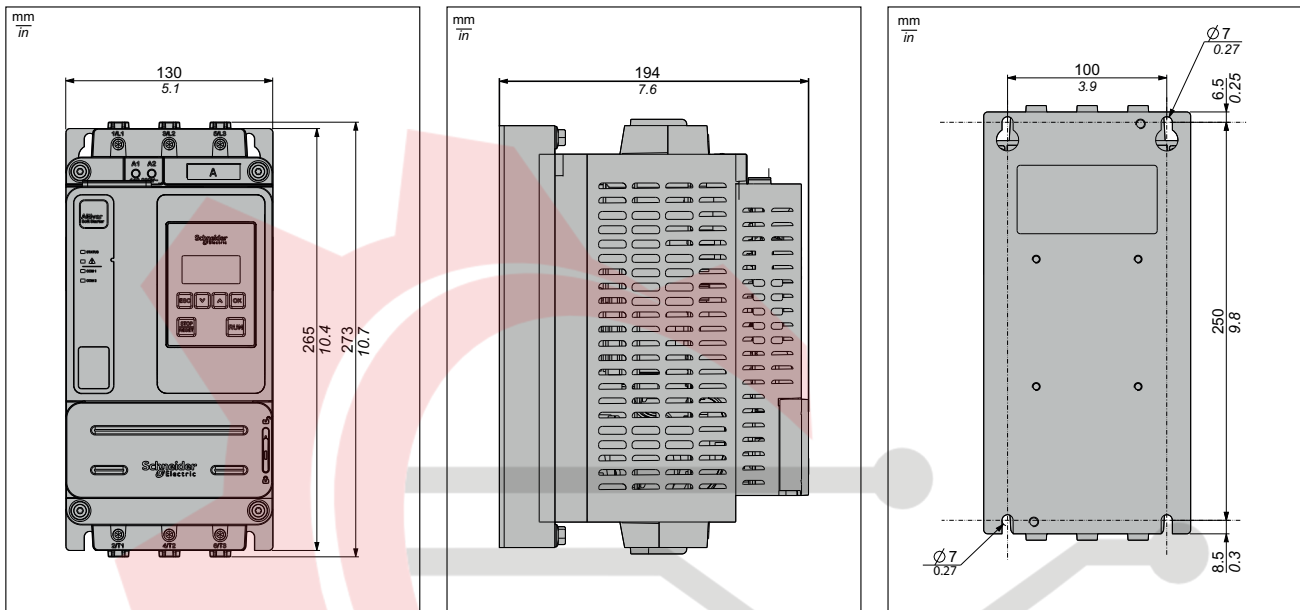

# ATS430D62S6...ATS430D75S6

## Front, Side and Rear View

Mounting screws x 4: M6

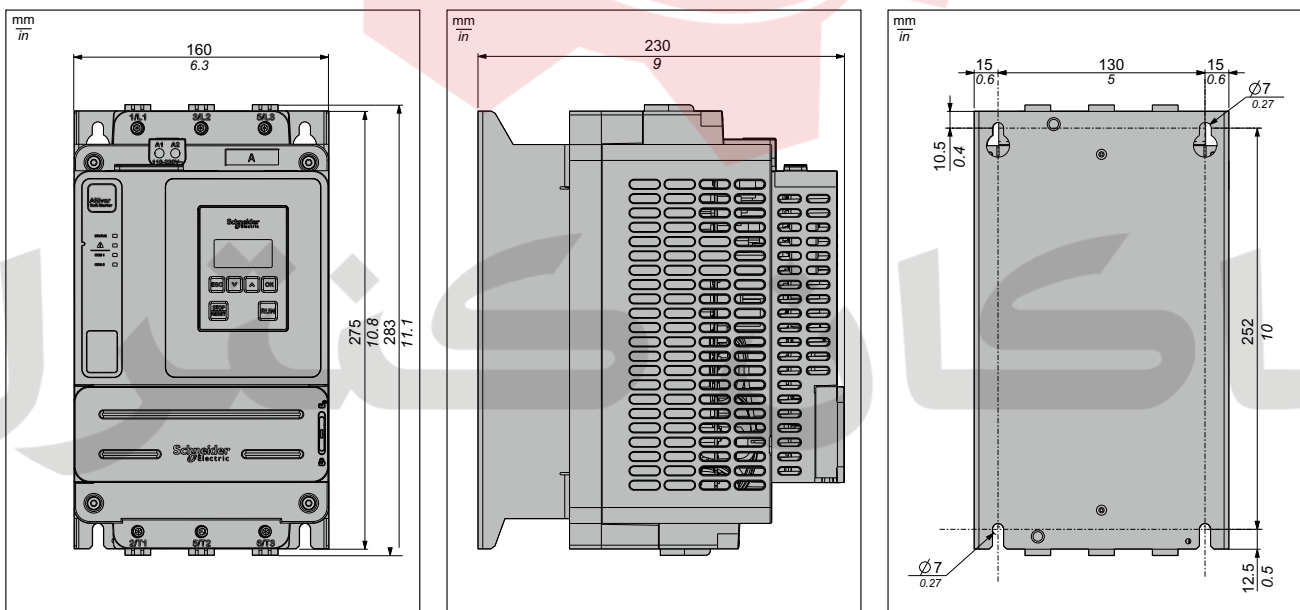

# ATS430D88S6...ATS430C11S6

## Front, Side and Rear View

Mounting screws x 4: M6

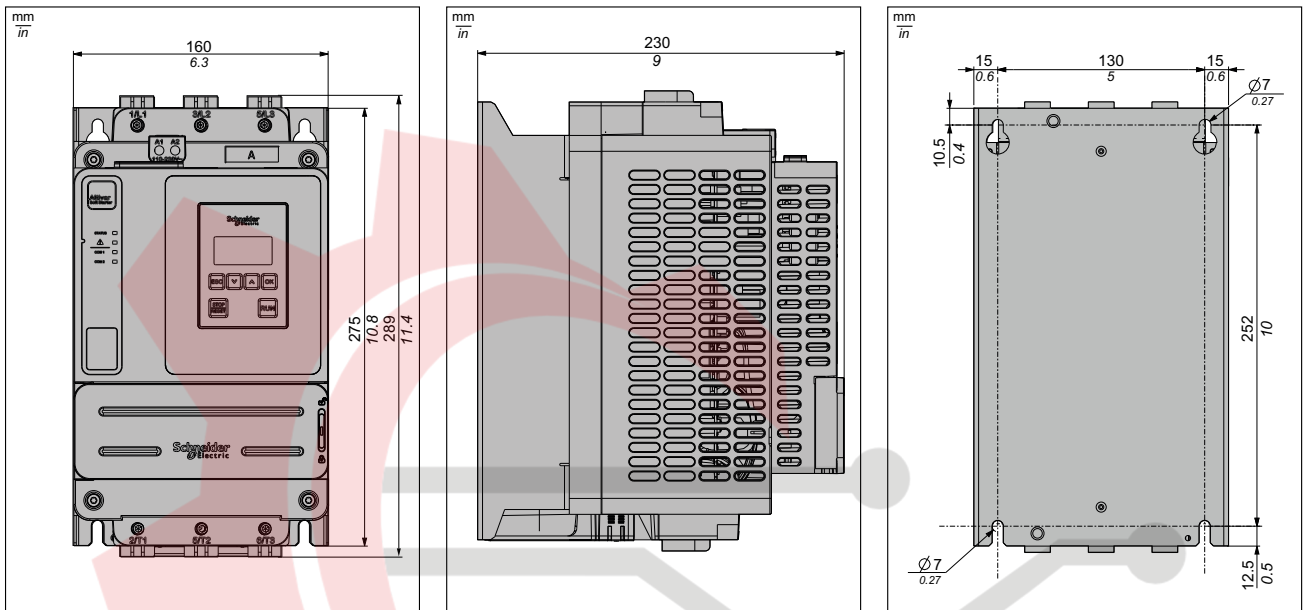

ماکان کنترول

# ATS430C14S6...ATS430C17S6

## Front, Side and Rear View

Mounting screws x 4: M6

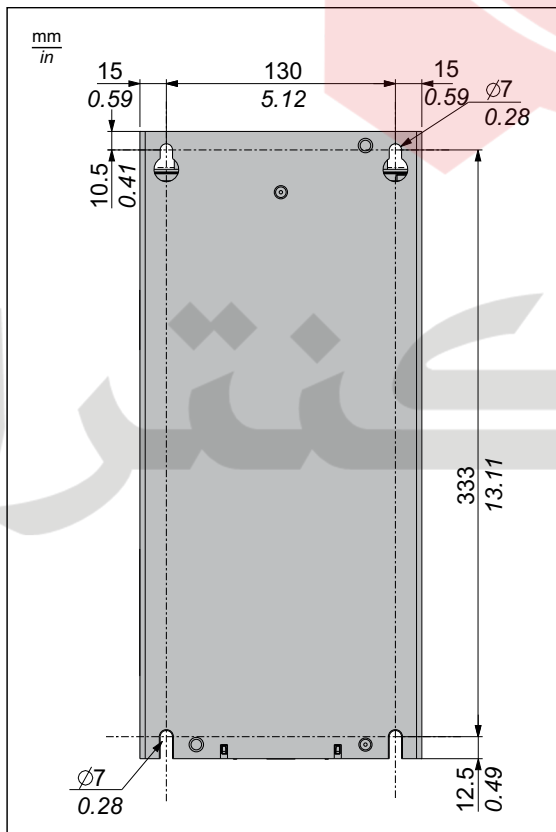
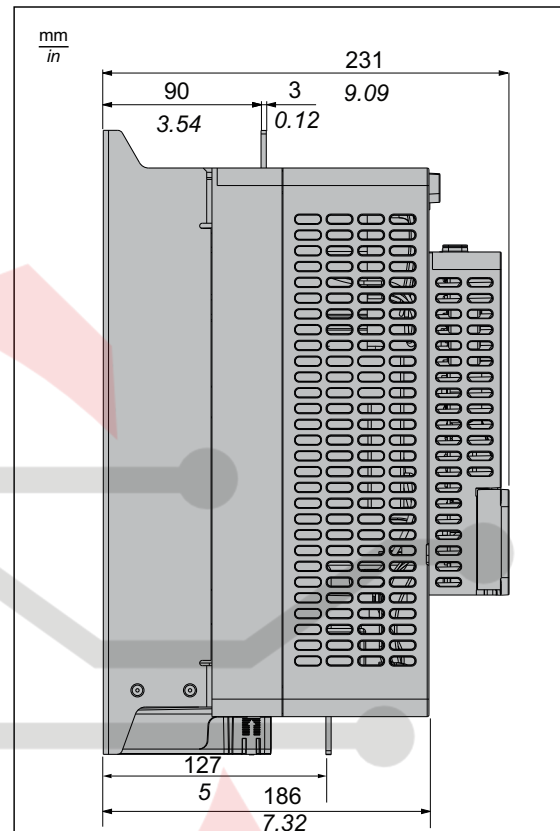
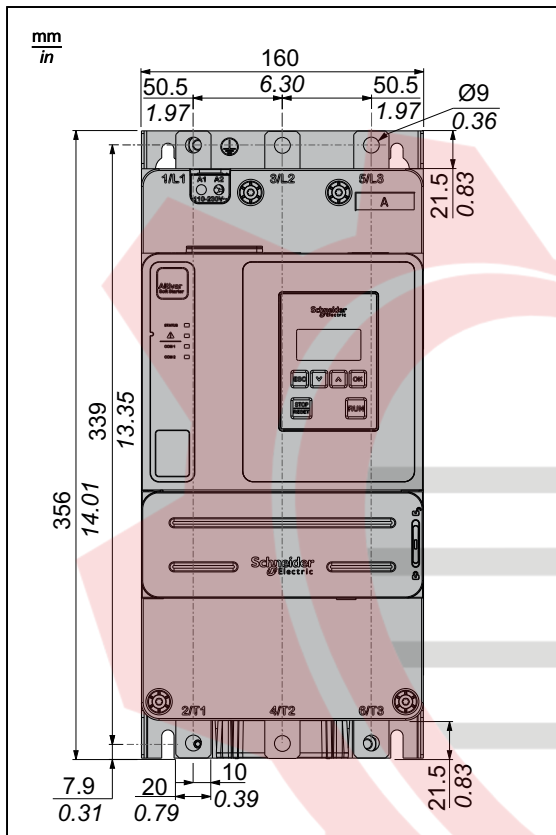

# ATS430C21S6...ATS430C41S6

## Front, Side and Rear View

Mounting screws x 4: M8

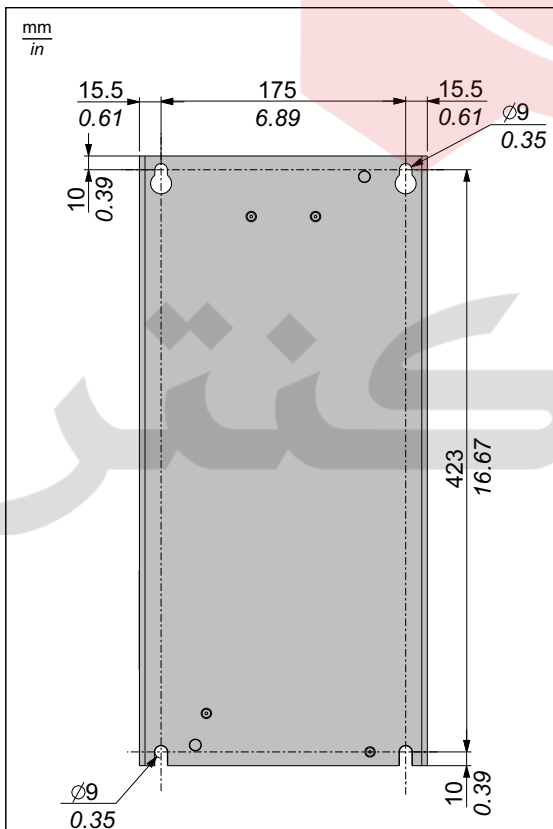
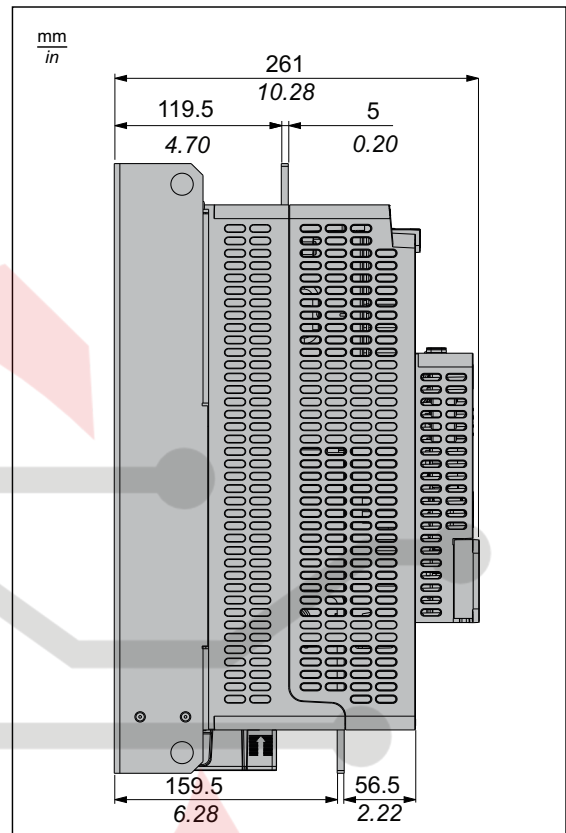
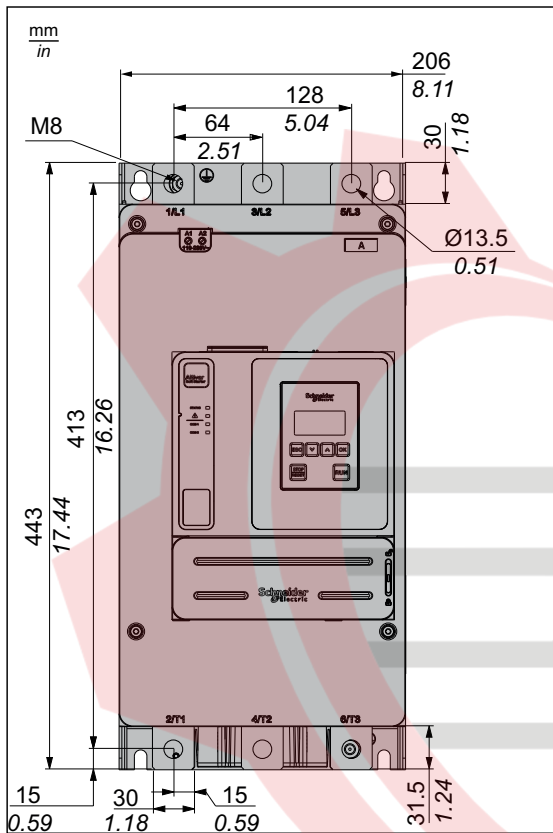

# ATS430C48S6...ATS430C59S6

## Front, Side and Rear View

Mounting screws x 4: M8

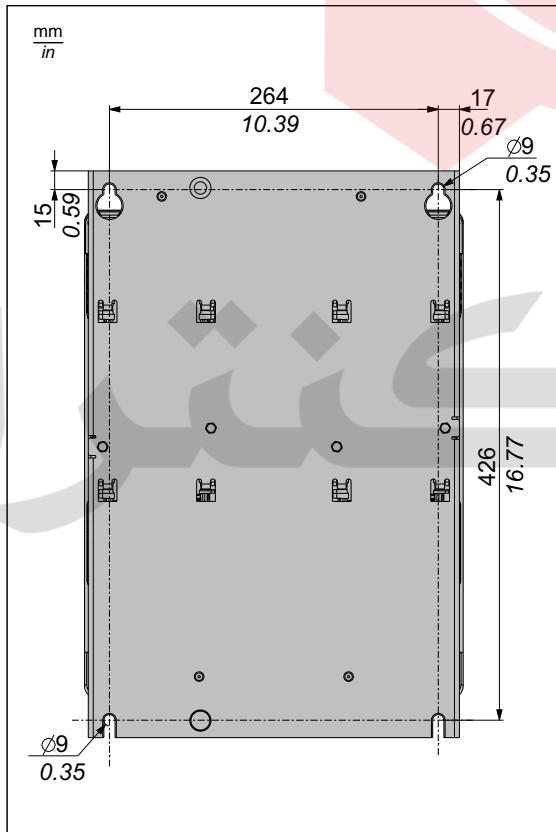
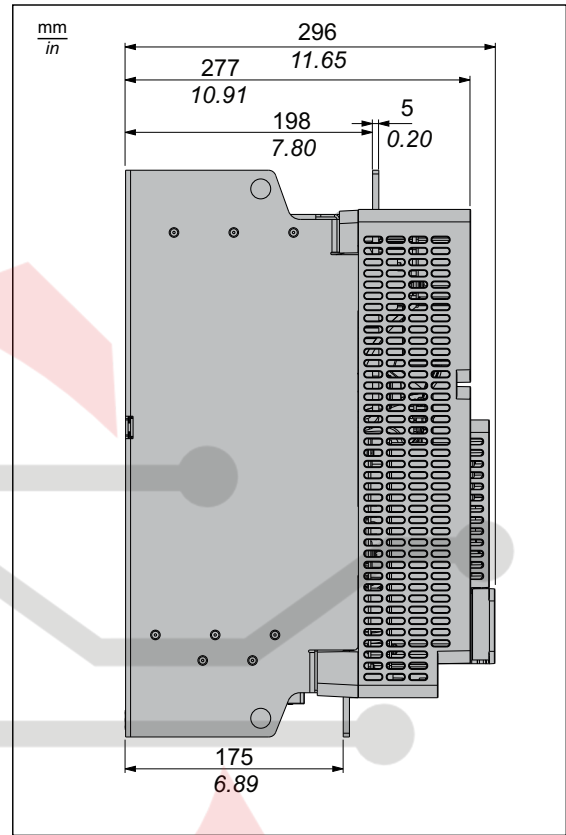
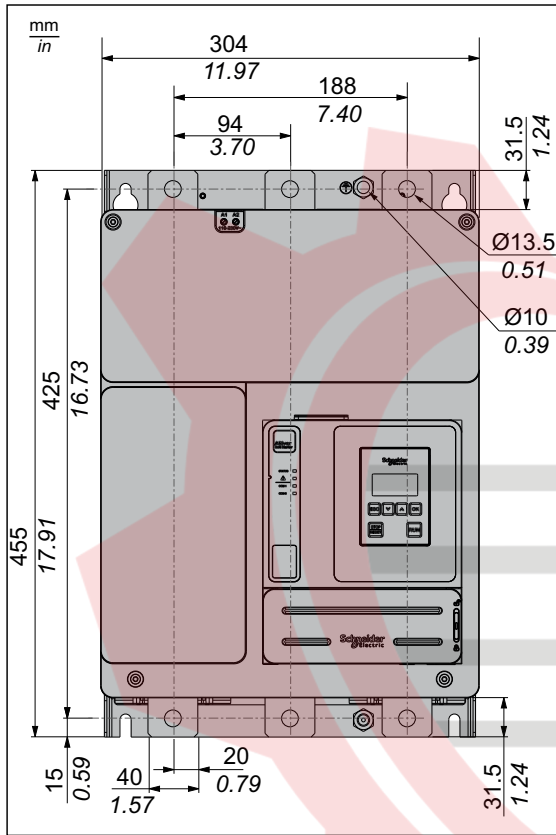

# Mounting Position

The soft starter is designed to be mounted inside cabinets vertically at  $\pm 10^\circ$  for cooling purposes.

Respect the minimum clearances so that the cooling air can circulate from the bottom to the top of the soft starter. The minimum clearances apply to any device close to the soft starter such as circuit breakers, fuses and contactors.

Do not install the soft starter above heating elements.

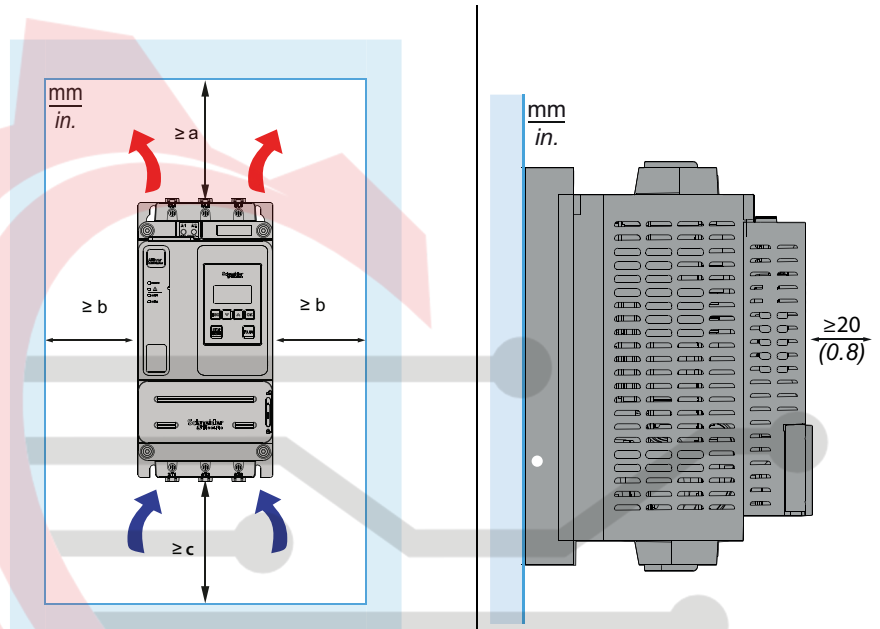

NOTE: Refer to the table below

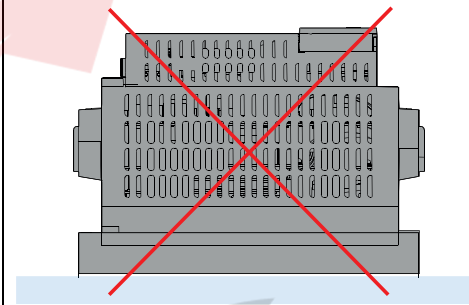
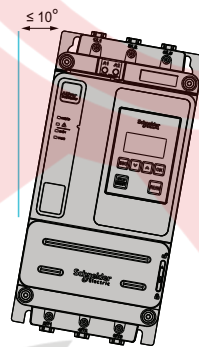

References	Minimum free space above the Soft Starter (a)	Minimum free space on the sides of the Soft Starter (b)	Minimum free space below the Soft Starter (c)
	mm (in)	mm (in)	mm (in)
ATS430D17S6...D47S6	100 (4)	10 (0.4)	100 (4)
ATS430D62S6...C17S6	75 (3)	10 (0.4)	60 (2.4)
ATS430C21S6...C41S6	85 (3.4)	10 (0.4)	60 (2.4)
ATS430C48S6...C59S6	100 (4)	20 (0.8)	75 (3)

## Enclosure Thermal Design

Conductive foreign objects may cause parasitic voltage.

### **⚡⚠ DANGER**

#### **ELECTRIC SHOCK AND/OR UNANTICIPATED EQUIPMENT OPERATION**

- Keep foreign objects such as chips, screws or wire clippings from getting into the product.
- Verify correct seat of seals and cable entries in order to avoid deposits and humidity.

**Failure to follow these instructions will result in death or serious injury.**

The temperature of the products described in this manual may exceed 80 °C (176 °F) during operation.

### **⚠ WARNING**

#### **HOT SURFACES**

- Ensure that any contact with hot surfaces is avoided.
- Do not allow flammable or heat-sensitive parts in the immediate vicinity of hot surfaces.
- Verify that the product has sufficiently cooled down before handling it.
- Verify that the heat dissipation is sufficient by performing a test run under maximum load conditions.

**Failure to follow these instructions can result in death, serious injury, or equipment damage.**

## Mounting in an Enclosure

### **⚡⚠ DANGER**

#### **HAZARD OF ELECTRIC SHOCK, EXPLOSION, OR ARC FLASH**

These products are open devices and must be mounted in a suitable enclosure.

**Failure to follow these instructions will result in death or serious injury.**

Use the enclosure manufacturers' specifications for proper sizing based on thermal considerations. It is necessary to add up the power dissipated by each device in the enclosure.

	Enclosure type		
	General purpose metal to reach IP23		Dust and damp-proof metal to reach IP54 / NEMA12
$\theta_e$ = external ambient temperature $\theta_i$ = internal ambient temperature of the enclosure			
Air circulation	Install air inlet	If air inlet is not adequate, install a forced ventilation unit, with a filter if necessary	Do not use insulated or non-metallic enclosures as they have poor thermal conduction. Provide a stirring fan to circulate air inside the enclosure and to help prevent hot spots in the soft starter.  This allows operation of the soft starter in an enclosure with a maximum internal temperature of 60 °C (140 °F)
Temperature around the soft starter	<ul style="list-style-type: none"> <li>-25...40 °C (-13...104 °F) without derating</li> <li>40...60 °C (104 ... 140 °F) with rated current (I<sub>e</sub>) derating of 1% per degree</li> </ul> Ensure that the ambient temperature around the soft starters does not exceed this limit.		

ماكان كنترول

## Estimation of power to be dissipated in the enclosure at 40°C

### Formula:

$$P_0 = (P_1 - (P_1 \times C_1) - (P_1 \times C_2)) \times C_3^4 \times C_4$$

With :

- $P_0$  =  $P_{Losses}$  during starting
- $P_1$  =  $P_{Losses}$  at In at 40°C
- $C_1$  = CoefTemperature Derating

Ambient temperatures around the device between 40°C (104 °F) to 60°C (140°F) reduce current by 1% per °C (1.8°F).

- $C_2$  = CoefAltitude Derating

Maximum operating altitude between 2000... 4800m (6600...15700ft) reduce current by 1% each additional 100m (330ft).

- $C_3$  = Coef%In
- $C_4$  = Power Coefficient

### Example of calculating an estimation of the power to be dissipated in the enclosure:

For an **ATS430C59S6**:

- $P_1 = 1063$  W
- at 60°C  $C_1 = 20 \times 0.01 = 0.2$
- at 2500m  $C_2 = 5 \times 0.01 = 0.05$
- at 400% In  $C_3 = 4$
- $C_4 = 1.23$

$$P_0 = (1063 - (1063 \times 0.2) - (1063 \times 0.05)) \times 4^4 \times 1.23 = 4327 \text{ W}$$

Reference	Power dissipated at nominal load (W)	Power loss during starting (W) at In during 13s P1	Power loss during starting (W) at 400%In during 13s	Fan consumption (W)	Power Coefficient C4	Minimum air flow rate required	
						m³/hour	ft³/min
ATS430D17S6	2	27	128	No fan	1,12	No fan	
ATS430D32S6	6	54	286		1,2		
ATS430D47S6	12	75	396		1,2		
ATS430D62S6	6	95	462		1,14		
ATS430D75S6	8	128	640		1,16		
ATS430D88S6	11	152	781	7,2	1,18	31	18
ATS430C11S6	18	190	1060	7,2	1,24	31	18
ATS430C14S6	19	217	1178	7,2	1,22	50	30
ATS430C17S6	28	269	1522	7,2	1,25	50	30
ATS430C21S6	35	347	1991	19,2	1,26	106	62
ATS430C25S6	47	401	2146	19,2	1,21	106	62
ATS430C32S6	46	538	3173	19,2	1,28	106	62
ATS430C41S6	76	687	4052	19,2	1,28	106	62
ATS430C48S6	81	849	4359	38,4	1,18	238	140
ATS430C59S6	122	1063	5769	38,4	1,22	238	140

**NOTE: Power dissipated at Ready state** (current independent) is **19 W**.

**NOTE:** The fans turn On when a RUN command is applied.

## IP20 kits

It is possible to limit direct access to the power terminals by installing IP20 kits:

- For ATS430C14S6...C17S6, refer to VW3G4701
- For ATS430C21S6...C41S6, refer to VW3G4702
- For ATS430C48S6...C59S6, refer to VW3G4703



ماکان کنترول

# Application Diagrams

## 1. Connection In Line, With Line Contactor, Type 1 or 2 Coordination, 2-wire control or 3-wire control

**Line contactor controlled based on RUN & STOP or on detected error. Stop following [Type of stop] STT.**

Simplified application diagram for local control using inputs of ATS430. Use relay output R1 set to **[Mains Contactor] LLC** to remove the mains supply on the soft starter when an error is detected or on STOP command.

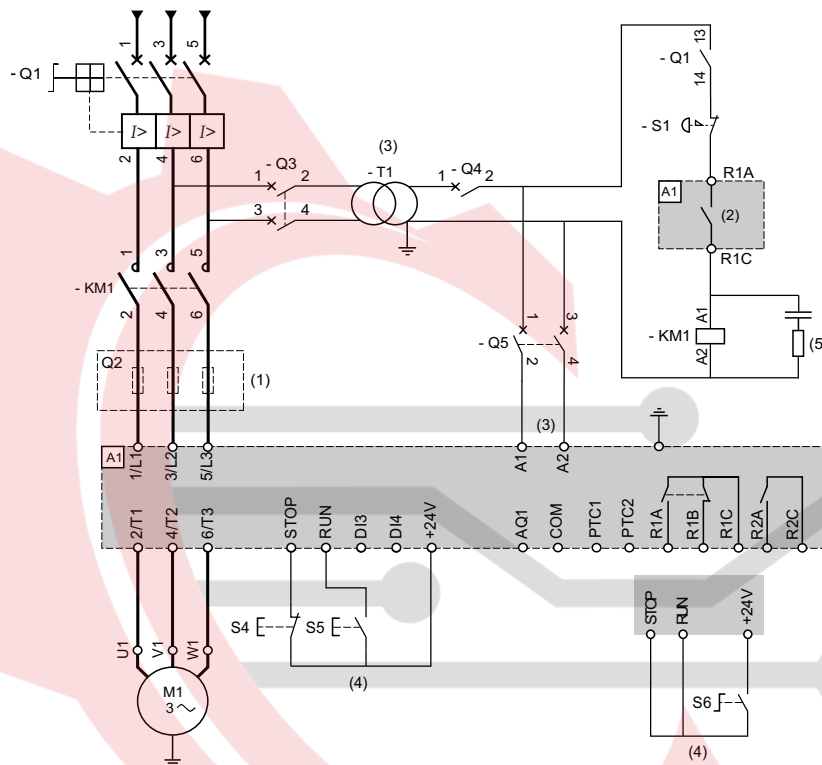

- (1) Installation of additional fast-acting fuses is mandatory to upgrade to type 2 coordination according to IEC 60947-4-2.
- (2) Take into account the electrical characteristics of the relays, refer to Control Terminal Characteristics, page 38.
- (3) The transformer must supply 110...230 Vac -15%...+10% 50/60Hz.
- (4) 3-wire control or 2-wire control. Refer to RUN and STOP Management, page 41.
- (5) To select the appropriate voltage surge suppressor refer to Relay Contacts Wiring, page 43.

Designation	Component	Description
Q1	Circuit breaker	Short circuit protection device for the motor
Q2	Circuit breaker	Short circuit protection device for the primary of the transformer
Q3	Fast acting fuses	Short circuit protection device of the soft starter to be used only when type 2 coordination according to IEC 60947-4-2 is required
Q4	Circuit breaker	Short circuit protection device for the secondary of the transformer
Q5	Circuit breaker	Short circuit protection device for the control part of the soft starter
KM1	Contactor	Line contactor
S1	Emergency Stop push-button	Emergency Stop to de-energized KM1 line contactor
S4	Normally close contact push-button	STOP command for 3-wire control
S5	Normally open contact push-button	RUN command for 3-wire control
S6	Selector switch, 2 positions, stay-put, normally open contact	RUN/STOP. command for 2-wire control

## 2. Connection In Line, With Line Contactor, Type 1 or 2 Coordination, 2-wire or 3-wire

### Line contactor controlled by Power ON and Power OFF push-buttons or detected error

This application diagram is well adapted to local control using inputs of ATS430. It requires a local intervention by pressing **S3** push button after the error reset even in case of remote control to have the mains supply at the soft starter.

Use relay output R1 set to **[Operating State Fault]** (factory setting) to turn Off the soft starter when an error is triggered by the device. A Stop by **S6** or **S4** does not open the line contactor.

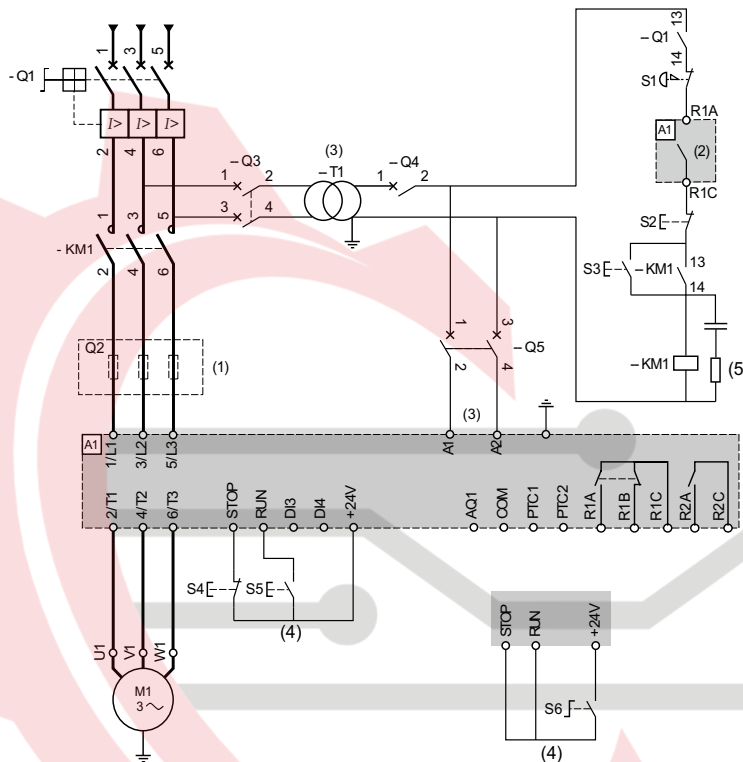

- (1) Installation of additional fast-acting fuses is mandatory to upgrade to type 2 coordination according to IEC 60947-4-2.
- (2) Take into account the electrical characteristics of the relays, refer to *Control Terminal Characteristics*, page 38
- (3) The transformer must supply 110...230 Vac -15%...+10%, 50/60Hz.
- (4) 3-wire control and 2-wire control. Refer to *RUN and STOP Management*, page 41.
- (5) To select the appropriate voltage surge suppressor refer to *Relay Contacts Wiring*, page 43.

Designation	Component	Description
Q1	Circuit breaker	Short circuit protection device for the motor
Q2	Circuit breaker	Short circuit protection device for the primary of the transformer
Q3	Fast acting fuses	Short circuit protection device of the soft starter to be used only when type 2 coordination
Q4	Circuit breaker	Short circuit protection device for the secondary of the transformer
Q5	Circuit breaker	Short circuit protection device for the control part of the soft starter
KM1	Contactor	Line contactor
S1	Emergency Stop push-button	Emergency Stop to de-energized KM1 line contactor
S2	Normally close push-button	Power OFF
S3	Normally open push-button	Power ON
S4	Normally close contact push-button	STOP command for 3-wire control
S5	Normally open contact push-button	RUN command for 3-wire control
S6	Selector switch, 2 positions, stay-put, normally open contact	RUN/STOP command for 2-wire control

## Type of coordination

The EN/IEC 60947-4-2 make a distinction between two different types of coordination, which are designated coordination type 1 and coordination type 2.

### Type 1 coordination:

Type 1 coordination requires that, under short-circuit conditions, the contactor or starter shall cause no danger to persons or installation and may not be suitable for further service without repair and replacement of parts.

### Type 2 coordination:

Type 2 coordination requires that, under short-circuit conditions, the contactor or starter shall cause no danger to persons or installation and shall be suitable for further use. The risk of contact welding is recognized, in which case the manufacturer shall indicate the measures to be taken as regards the maintenance of the equipment.

**NOTE:** Use of an Short-Circuit Protective Device not in compliance with the manufacturer's recommendations can invalidate the coordination.

Refer to the Schneider Electric Catalogue to select the appropriate coordination components.

## Thermal monitoring

- Soft Starter Thermal monitoring is provided by the NTC sensor fitted on the heatsink and a function calculating the temperature rise of the thyristors.
- The Soft Starter will help to protect the motor and the cables against overloads. If this monitoring function is disabled, external thermal monitoring must be provided.

ماکان کنترول

# Control Block Wiring Diagram

**⚡ ⚠ DANGER**

**ELECTRIC SHOCK CAUSED BY INCORRECT POWER SUPPLY UNIT**

The +24 Vdc supply voltage is connected with many exposed signal connections in the device.

- Use a power supply unit that meets the PELV (Protective Extra Low Voltage) requirements.

**Failure to follow these instructions will result in death or serious injury.**

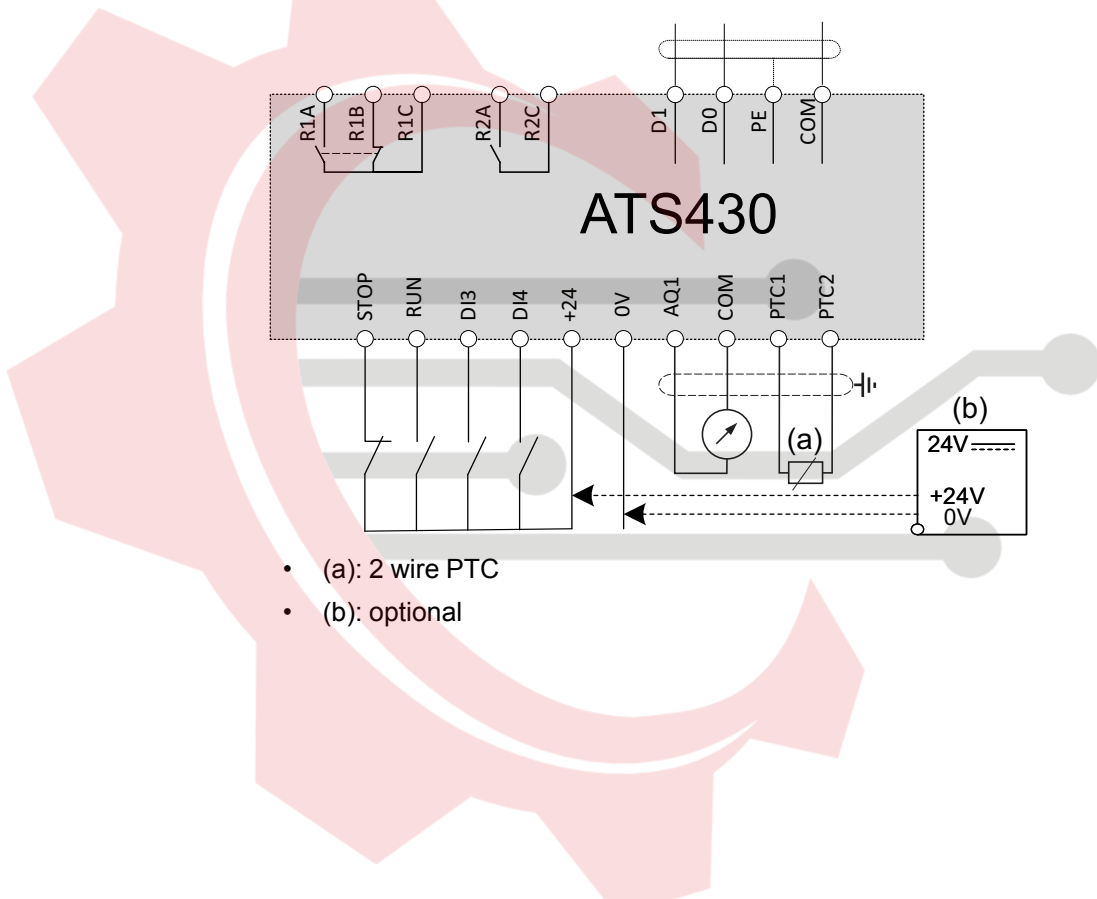

- (a): 2 wire PTC
- (b): optional

ماکان کنترول

# Control Terminal Characteristics

The ATS430 can start and stop the motor in “2–wire control” or “3–wire control”, depending on how the STOP and RUN terminals are wired. Simple diagrams explaining those two modes and how to wire the terminals STOP and RUN are available at RUN and STOP Management, page 41.

Complete application diagrams including power and control connections are available at Application Diagrams, page 34.

To maintain communication with the soft starter when A1 and A2 are absent, the ATS430 control part can be supplied in 24 Vdc via the terminal +24.

**To control the motor, the ATS430 must be supplied in 110...230 Vac via the terminals A1 and A2.**

<b>NOTICE</b>	
<b>INCORRECT VOLTAGE</b>	
<ul style="list-style-type: none"> <li>Supply the control supply terminals A1 / A2 within a range of 110...230 Vac only</li> </ul>	
<b>Failure to follow these instructions can result in equipment damage.</b>	

Reference	Apparent power (VA) for control supply A1–A2
ATS430D17S6...D62S6	70
ATS430D75S6...C17S6	80
ATS430C21S6...C41S6	90
ATS430C48S6...C59S6	280

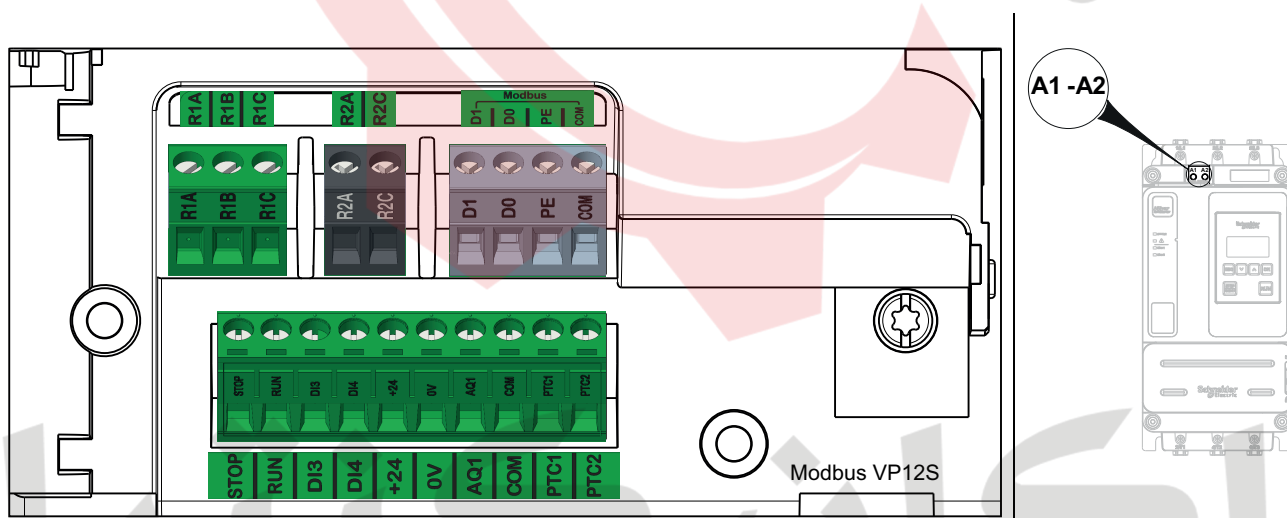

**Control terminal wires specifications :**

Tightening torque max N.m (lbf.in)	Min relay output wire cross section mm <sup>2</sup> (AWG)	Other min wire cross section mm <sup>2</sup> (AWG)	Max connection capacity mm <sup>2</sup> (AWG)	Stripping length mm (in)	
				Min	Max
0.5 (4.4)	0.75 (18)	0.5 (20)	1.5 (16)	5.5 (0.2)	7.5 (0.3)

Those values are given for a single wire per terminal. Use a shunt to create a bridge between terminals if necessary.

**Control supply terminals A1/A2 wires specifications :**

Tightening torque max N.m (lbf.in)	Min wire cross section mm <sup>2</sup> (AWG)	Max connection capacity mm <sup>2</sup> (AWG)	Stripping length mm (in)	
			Min	Max
0.5 (4.4)	0.5 (20)	2.5 (14)	5.5 (0.2)	7.5 (0.3)

Terminals	Function	I/O	Characteristics	
R1A	R1A — R1C : NO	O	<ul style="list-style-type: none"> <li>Max voltage: 250 Vac.</li> <li>Min. switching capacity: 10 mA for 24 Vdc</li> <li>Max. switching capacity on inductive load following IEC60947-2:               <ul style="list-style-type: none"> <li>2A/250Vac for AC15 100 000 cycles</li> <li>2A/30Vdc for DC13 150 000 cycles</li> </ul> </li> </ul> Inductive load must be equipped with a voltage surge suppression device according to AC or DC operation with total energy dissipation greater than the inductive energy stored in the load.  Refer to sections Output Relay with Inductive AC Loads, page 43 and Output Relay with Inductive DC Loads, page 44.	
R1B	R1B — R1C : NC			
R1C	Programmable relay R1 – Assigned to Operating state Fault by default			
R2A	NO relay R2 – Assigned to End of starting. Will close when the soft starter is in established regime.	O		
R2C				
D0	Serial link based on 2-wire Modbus over serial line electrical interface.	I/O	<ul style="list-style-type: none"> <li>Baud rate:               <ul style="list-style-type: none"> <li>Min = 4.8 kbps</li> <li>Max = 38.4 kbps</li> <li>Factory Setting= 19.2 kbps</li> </ul> </li> <li>Data bits: 8 bits</li> <li>Parity: None, Odd, Even</li> <li>Maximum current: 10 mA</li> </ul>	
D1				
PE	Protective Earth connection	I/O		
COM	I/O common	I/O		
STOP	Digital Input 1 — Assigned to STOP	I	<ul style="list-style-type: none"> <li>4 x 24 Vdc digital inputs with 4.4 kΩ impedance</li> <li>U<sub>max</sub> = 30 V</li> <li>I<sub>max</sub> = 7 mA</li> <li>State 1: U &gt; 11 V and I &gt; 5 mA</li> <li>State 0: U &lt; 5 V and I &lt; 2 mA</li> <li>Response time: 2 ms ± 0.5 ms max</li> </ul>	
RUN	Digital Input 2 — Assigned to RUN	I		
DI3	Digital Input 3	I		
DI4	Digital Input 4	I		
0V	Common for +24	I/O		<ul style="list-style-type: none"> <li>0 V</li> </ul>

Terminals	Function	I/O	Characteristics
+24	Supply for digital output	I/O	<ul style="list-style-type: none"> <li>• Umin: 19 Vdc</li> <li>• Unominal: 24 Vdc</li> <li>• Umax: 30 Vdc</li> <li>• Imax: 200 mA</li> <li>• Isolated and protected against short-circuits and overloads, maximum current 200 mA.</li> <li>• Can be used to supply the control block with an external 24Vdc supply if A1 and A2 are absent to keep communication with the product</li> </ul> <p><b>NOTE:</b> The +24 terminal does not entirely substitute supply from A1 and A2. The motor cannot be controlled if you supply the ATS430 via only the +24 terminal. To control the motor, the ATS430 must be supplied via A1 and A2.</p>
AQ1	Programmable analog Output 1	O	<ul style="list-style-type: none"> <li>• Available signal: 0 —10 Vdc. Minimum load impedance 470 Ω 0 —20 mA ; 4 —20 mA, can be configured to custom value. Maximum load impedance 500 Ω</li> <li>• Accuracy ± 1% for temperature range —10 to +60°C</li> <li>• Resolution: 10 bits</li> <li>• Linearity: ± 0.2%</li> <li>• Sampling time: 5 ms + 1 ms maximum</li> </ul>
COM	I/O common	I/O	<ul style="list-style-type: none"> <li>• 0 V</li> </ul>
PTC1	Motor thermal sensor connection	I	<ul style="list-style-type: none"> <li>• Configurable for PTC</li> <li>• Total resistance of sensor circuit 750 Ω at 25°C</li> <li>• Overheat trigger threshold: 2.9 kΩ ± 0.2 kΩ</li> <li>• Overheat reset threshold: 1.575 kΩ ± 0.75 kΩ</li> <li>• Threshold for low impedance detection: 50 Ω –10 Ω/+20 Ω</li> <li>• Protected for low impedance &lt; 1000 Ω</li> </ul> <p>Refer to [Thermal monitoring] TPP, page 132 for more information on thermal sensors.</p>
PTC2			

ماکان کنترول

# RUN and STOP Management

## 2-wire control

Run and Stop are controlled by state 1 (closed, active) or 0 (open, inactive), on the Run and Stop terminals.

At power-up or on manual error reset, the motor will start if RUN is active.

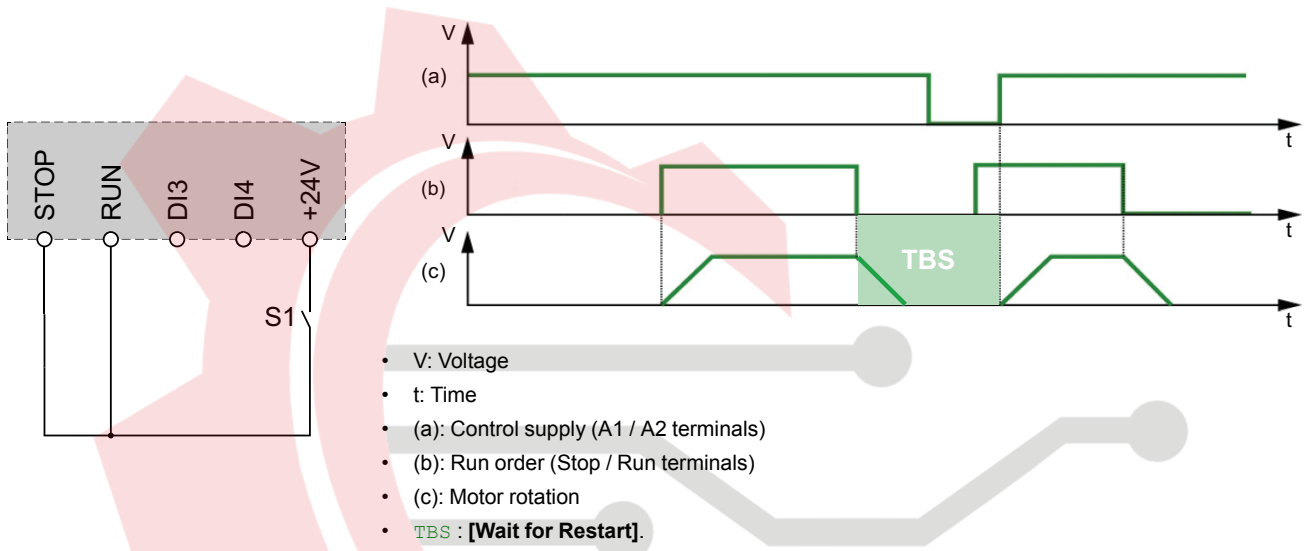

ماكان كنترول

## 3-wire control

Run and Stop are controlled by 2 different digital inputs.

The Stop order is applied at low level on the Stop terminal.

The Run order is applied at high level on the Run terminal only if Stop terminal is at high level.

On Power-up or manual Error Reset or after a Stop command coming from the active channel command, the motor will be powered if a Run command is active. If a Stop command is applied via a different channel command, the motor can only be powered again by removing the active Run command and applying a new one.

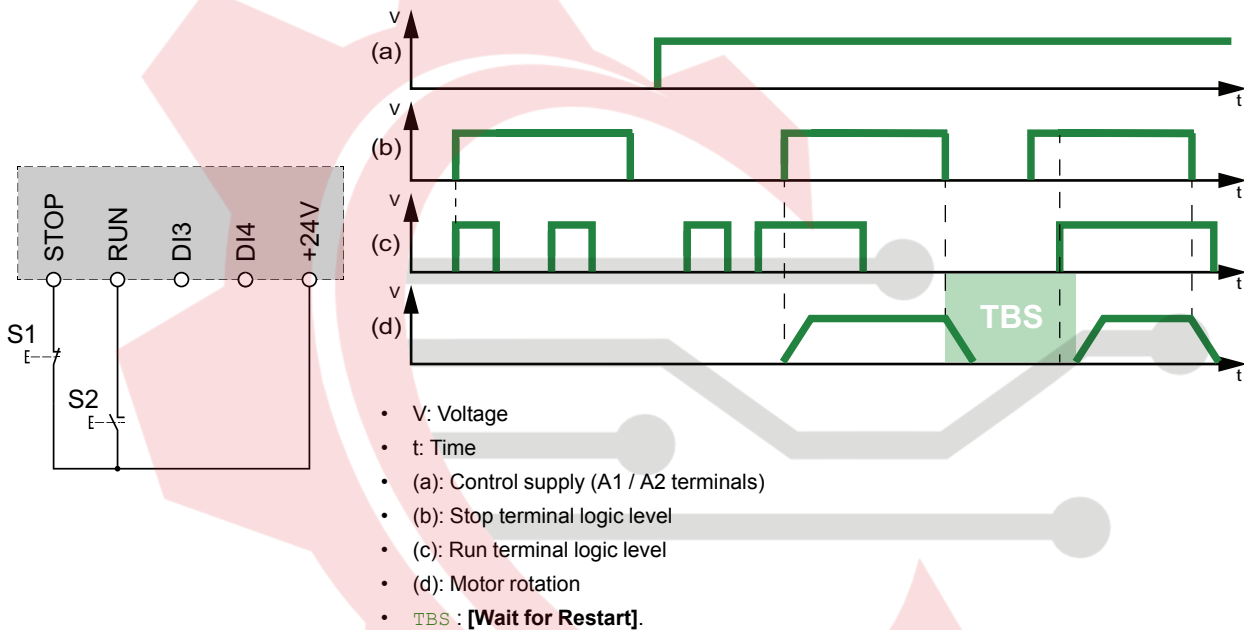

Applying a Run order when **[Fault Reset Assign] RSF** is set to **[Not Assigned] NO** will reset the soft starter. A second Run order is necessary to restart the motor.

ماکان کنترول

# Relay Contacts Wiring

## General

The AC voltage source must be of overvoltage category II (OVC II) according to IEC 60947-4-2 and IEC 60947-1.

If it is not the case, an isolation transformer must be used.

## Contactors with AC Coil

If controlled by a relay, a resistor-capacitor (RC) circuit must be connected in parallel to the coil of the contactor as shown on the drawing below.

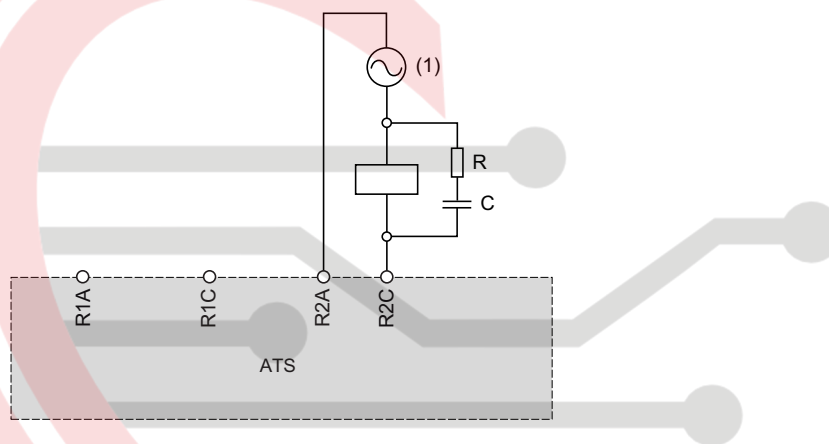

(1) AC 250 Vac maximum.

Schneider Electric AC contactors have a dedicated area on the housing to plug easily the RC device. Refer to the Motor control and protection components catalog MKTED210011EN available on [se.com](http://se.com) to find the RC device to be associated with the contactor used.

**Example:** With a 48 Vac source, contactors LC1D09E7 or LC1DT20E7 have to be used with LAD4RCE voltage suppression device.

## Other Inductive AC Loads

For other inductive AC loads:

- Use an auxiliary contactor connected on the product to control the load.

**Example:** with a 48 Vac source, auxiliary contactors CAD32E7 or CAD50E7 with LAD4RCE voltage suppression device.

- When using a third-party inductive AC load, request the supplier to provide information on the voltage suppression device, in order to avoid overvoltage above 375 V during relay opening.

## Contactors with DC Coil

If controlled by a relay, a bidirectional transient voltage suppression (TVS) diode, also called transil, must be connected in parallel to the coil of the contactor as shown on the drawing below.

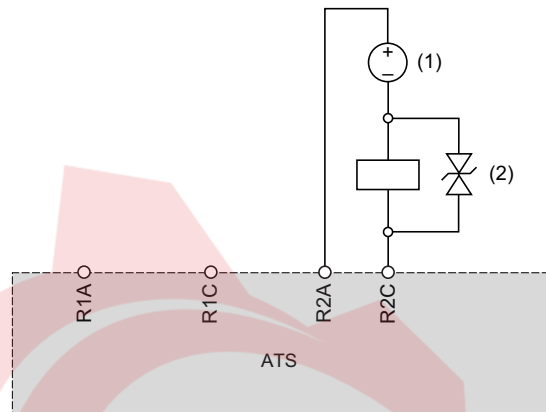

(1) DC 30 Vdc maximum.

(2) TVS diode

Schneider Electric contactors with DC coil include the TVS diode. No additional device is required.

Refer to the Motor control and protection components catalog MKTED210011EN available on [se.com](http://se.com) for more information.

# ماکان کنترول

## Other Inductive DC Loads

Other inductive DC loads without embedded TVS diode must use one of the following voltage suppression device:

- A bidirectional TVS device as shown on the drawing above, defined by:
  - TVS break-down voltage greater than 35 Vdc,
  - TVS clamping voltage  $V(\text{TVS})$  less than 50 Vdc
  - TVS peak power dissipation greater than load rated current,  $I(\text{load}) \times V(\text{TVS})$ .

**Example:** with  $I(\text{load}) = 0.9 \text{ A}$  and  $V(\text{TVS}) = 50 \text{ Vdc}$ , TVS peak power must be greater than 45 W

- TVS average power dissipation greater than the value calculated by the following  $0.5 \times I(\text{load}) \times V(\text{TVS}) \times \text{load time constant} \times \text{number of operation per second}$ .

**Example:** with  $I(\text{load}) = 0.9 \text{ A}$  and  $V(\text{TVS}) = 50 \text{ Vdc}$ , load time constant = 40 ms (load inductance divided by load resistance) and 1 operation every 3 s, the TVS average power dissipation must be greater than  $0.5 \times 0.9 \times 50 \times 0.04 \times 0.33 = 0.3 \text{ W}$ .

- A fly-back diode as shown in the drawing below.

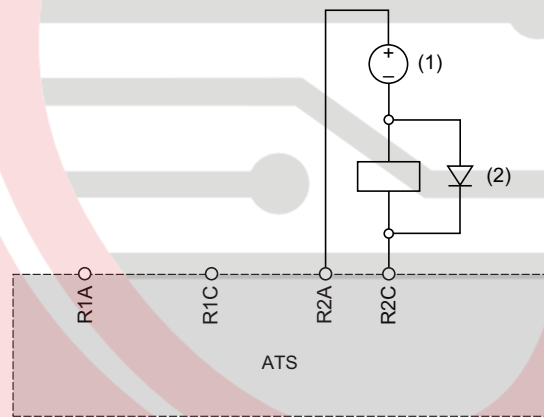

(1) DC 30 Vdc maxi.

(2) Flyback diode

The diode is a polarized device. The fly-back diode must be defined by:

- A reverse voltage greater than 100 Vdc,
- A rated current greater than two times the load rated current,
- A thermal resistance: junction to ambient temperature (in K/W) less than  $90 / (1.1 \times I(\text{load}))$  to operate at maximum  $60^\circ\text{C}$  ( $140^\circ\text{F}$ ) ambient temperature.

**Example:** with  $I(\text{load}) = 1.5 \text{ A}$ , select a 100 V, 3 A rated current diode with a thermal resistance from junction to ambient less than  $90 / (1.1 \times 1.5) = 54.5 \text{ K/W}$ .

Using a flyback diode, the relay opening time will be longer than with a TVS diode.

**NOTE:** Use diodes with leads for easy wiring and keep at least 1 cm (0.39 in.) of leads on each side of the case of the diode for a correct cooling.

## Software and Tools

**NOTE:** Make sure that the latest version of the software and of the manuals are used.

### SoMove



SoMove is a setup software for PC designed to configure Schneider Electric motor control devices. It incorporates functions for device setup, monitoring, fieldbus management and maintenance via an user-friendly interface.

To download SoMove go to SoMove FDT.

To download the required DTM refer to ATS430: DTM, page 14.

A contextual help for SoMove is available by pressing F1 on the keyboard.

ماکان کنترول

# Cybersecurity Generalities

## What's in This Chapter

Overview .....	48
Security Policy .....	51
Product Defense-in-Depth.....	52
ATS430 Security Policy.....	54
Potential Risks and Compensating Controls .....	56
Data Flow Restriction.....	56
Device Recovery and Reconstitution.....	57



ماکان کنترول

## Overview

Title of documentation	Catalog number
Recommended Cybersecurity Best Practices	7EN52-0390 (English)

The objective of Cybersecurity is to help provide increased levels of protection for information and physical assets from theft, corruption, misuse, or accidents while maintaining access for their intended users.

No single Cybersecurity approach is adequate. Schneider Electric recommends a defense-in-depth approach. Conceived by the National Security Agency (NSA), this approach layers the network with security features, appliances, and processes.

The basic components of this approach are:

- Risk assessment
- A security plan built on the results of the risk assessment
- A multi-phase training campaign
- Physical separation of the industrial networks from enterprise networks using a demilitarized zone (DMZ) and the use of firewalls and routing to establish other security zones
- System access control
- Device hardening
- Network monitoring and maintenance

This chapter defines the elements that help you configure a system that is less susceptible to cyber-attacks.

Network administrators, system integrators and personnel that commission, maintain or dispose of a device should:

- Apply and maintain the device's security capabilities. See for details
- Review assumptions about protected environments. See Protected Environment Assumptions sub-chapter for details.
- Address potential risks and mitigation strategies. See Product Defense-in-Depth sub-chapter for details.
- Follow recommendations to optimize cybersecurity.

For detailed information on the system defense-in-depth approach, refer to the TVDA: How Can I Reduce Vulnerability to Cyber Attacks (STN V3.0) on se.com.

To submit a Cybersecurity question, report security issues, or get the latest news from Schneider Electric, visit the [Schneider Electric website](#).

### **▲ WARNING**

#### **POTENTIAL COMPROMISE OF SYSTEM AVAILABILITY, INTEGRITY, AND CONFIDENTIALITY**

- Change default password to help prevent unauthorized access to device settings and information.
- Disable unused ports/services and default accounts, where possible, to minimize pathways for malicious attacks.
- Place networked devices behind multiple layers of cyber defenses (such as firewalls, network segmentation, and network intrusion detection and protection).
- Use cybersecurity best practices (for example: least rights, separation of duties) to help prevent unauthorized exposure, loss or modification of data and logs, interruption of services, or unintended operation.

**Failure to follow these instructions can result in death, serious injury, or equipment damage.**

## Protected Environment Assumptions

Machines, controllers, and related equipment are usually integrated into networks. Unauthorized persons and malware may gain access to the machine as well as to other devices on the network/fieldbus of the machine and connected networks via insufficiently secure access to software and networks.

### ⚠ WARNING

#### UNAUTHORIZED ACCESS TO THE MACHINE VIA SOFTWARE AND NETWORKS

- In your hazard and risk analysis, consider all hazards that result from access to and operation on the network/fieldbus and develop an appropriate cybersecurity concept.
- Verify that the hardware infrastructure and the software infrastructure into which the machine is integrated as well as all organizational measures and rules covering access to this infrastructure consider the results of the hazard and risk analysis and are implemented according to best practices and standards covering IT security and cybersecurity (such as: ISO/IEC 27000 series, Common Criteria for Information Technology Security Evaluation, ISO/IEC 15408, IEC 62351, ISA/IEC 62443, NIST Cybersecurity Framework, Information Security Forum - Standard of Good Practice for Information Security, SE recommended Cybersecurity Best Practices\*).
- Verify the effectiveness of your IT security and cybersecurity systems using appropriate, proven methods.

**Failure to follow these instructions can result in death, serious injury, or equipment damage.**

(\*) : SE Recommended Cybersecurity Best Practices can be downloaded on SE.com.

Additionally, use a layered network approach with multiple security and defense controls in your IT and control system to minimize data protection gaps, reduce single-points of failure and create a strong cybersecurity posture. The more layers of security in your network, the harder it is to breach defenses, take digital assets or cause disruption.

#### Control System - Cybersecurity policy

- Cybersecurity governance – available and up-to-date guidance on governing the use of information and technology assets in your company that is matching with a dedicated risk analysis about the control system
- The access control policy defined in the cybersecurity governance is strictly applied. In particular, it guarantees the authenticity of privileged operations. For example operations that can alter the critical assets.
- The instructions and procedures should structure the roles and responsibilities in terms of security within the organization; in other words, who is authorized to perform what and when. These should be known by the users.
- Define information security continuous monitoring (ISCM) to maintain the awareness of information security, vulnerabilities and threats to your organization.
- Perform patch management by applying security patches from vendor to ensure stability and completeness.

#### Physical perimeter security

- Set up the devices in an enclosed area with physical access control to prevent unauthorized access to the device, with dedicated monitoring

### Physical network segmentation

Independence from non-control system networks – the control system provides network services to control system networks, critical or non-critical, without a connection to non-control system networks

- Physically segment control system networks from non-control system network
- Physically segment critical control system networks from non-critical control system networks

### Logical isolation of critical networks

The control system provides the capability to logically and physically isolate critical control system networks from non-critical control system networks. For example, using VLANs.

Zone boundary protection – the control system provides the capability to:

- Manage connections through managed interfaces consisting of appropriate boundary protection devices, such as: proxies, gateways, routers, firewalls, and encrypted tunnels
- Use an effective architecture, for example, firewalls protecting application gateways residing in a DMZ
- Control system boundary protections at any designated alternate processing sites should provide the same levels of protection as that of the primary site, for example, data centers

No public internet connectivity – access from the control system to the internet is not recommended

### Information disclosure prevention

- Encrypt protocol transmissions over all external connections using an encrypted tunnel, TLS wrapper or a similar solution
- Reduce access to control system information by distributing permissions according to predefined access control with least privilege practices

### Control against malware

- Detection, prevention, and recovery controls to help protect against malware are implemented and combined with appropriate user awareness
- Any computer in use on the control system either on premise or temporarily connected, should have an updated anti-virus, anti-malware, anti-ransomware application activated during the use

### Resource & control system availability

- Ensure continuity of service – ability to break the connections between different network segments or use duplicate devices in response to an incident. RSTP, redundancy of controllers or network device like switches or similar solution.
- Manage communication loads – the control system provides the capability to manage communication loads to mitigate the effects of information flooding types of DoS (Denial of Service) events
- Manage the retention cycles of data and programs with the retention periods determined as appropriate. FDR can be used for instance.

## Security Policy

### ⚠ WARNING

#### ACCESSIBILITY LOSS

- Setup a security policy to your device and backup the device image with security administrator user account.
- Define and regularly review the password policy.
- Periodic change of the passwords, Schneider Electric recommends a modification of the password each 90 days.

**Failure to follow these instructions can result in death, serious injury, or equipment damage.**

Cybersecurity helps to provide:

- Confidentiality (to help prevent unauthorized access)
- Integrity (to help prevent unauthorized modification)
- Availability/authentication (preventing the denial of service and assuring authorized access)
- Non-repudiation (preventing the denial of an action that took place)
- Traceability/detection (logging and monitoring)

Norm IEC 62443 is the worldwide standard for security of industrial control system (ICS) networks.

From the norm definition, Altivar Soft Starter ATS430 is considered as Embedded Device of the ICS network, and has been designed following the norm IEC62443-4-1 and the technical security requirements are defined in compliance with norm IEC 62443-4-2.

Altivar Soft Starter ATS430 security features prevent the unauthorized disclosure of information via eavesdropping or casual exposure.

For an efficient security, the instructions and procedures should structure the roles and responsibilities in terms of security within the organization; in other words, who is authorized to perform what and when. These should be known by the users.

The anti-intrusion and anti-physical access to any sensitive installation should be set up.

All the security rules implemented in the ATS430 are in complement of the points above.

ماکان کنترول

The device does not have the capability to transmit data encrypted using the Modbus slave over serial protocol. If other users gained access to your network, transmitted information can be disclosed or subject to tampering.

<b>⚠ WARNING</b>
<b>CYBERSECURITY HAZARD</b>
<ul style="list-style-type: none"> <li>For transmitting data over an internal network, physically or logically segment the network, the access to the internal network needs to be restricted by using standard controls.</li> </ul>
<b>Failure to follow these instructions can result in death, serious injury, or equipment damage.</b>

The access through the digital inputs is not controlled.

Any computer using SoMove, DTM or EcoStruxure Control Expert should have an updated anti-virus, anti-malware, anti-ransomware application activated during the use.

The ATS430 have the capability to export its settings and files manually or automatically. It is recommended to archive any settings and files (device backup images, device configuration, device security policies) in a secure area.

## Product Defense-in-Depth

Altivar Soft Starter ATS430 offers the following security features:

Threats	Desired security property on Embedded Device	ATS430 security features
Information disclosure	Confidentiality	Password encrypted in a non-reversible way
		User access control
Tampering	Device integrity	Cryptographic signature of firmware package
		Secure root of trust
Denial of Service	Availability	Device backup/restore
		Security export/import
Spoofing/Elevation of privilege	User Authentication / Authorization	Strong password and user account policy
		Access control local display terminal
		Access control commissioning tools Modbus Serial
Elevation of privilege	Authorization	Port hardening
		User roles & rights
Repudiation	Non-repudiability	Secure event logging

## Confidentiality

Information confidentiality capacity prevents unauthorized access to the device and information disclosure.

- The user access control helps on managing users that are authorized to access the device. Protect user credential at usage.
- The user’s passwords are encrypted in non-reversible way at rest

## Device Integrity Protection

The device integrity protection prevents unauthorized modification of the device with tampered or spoofed information.

This security capability helps protect the authenticity and integrity of the firmware running on the ATS430 and facilitates protected file transfer: digitally signed firmware is used to help protect the authenticity of the firmware running on the ATS430 and only allows firmware generated and signed by Schneider Electric.

- Cryptographic signature of the firmware package executed at the firmware update
- Secure root of trust ensures integrity and authenticity of the device firmware at each power-up

## Availability

The control system backup is essential for recovery from a control system failure and/or misconfiguration and participate on preventing denial of service. It also helps ensure global availability of the device by reducing operator overhead on security application/deployment.

These security capabilities help manage control system backup with the device:

- Independent security policy import/export for local secure backup and security policy sharing with other devices.
- Complete device backup/restore available on local HMI and DTM.

## Authentication and Authorization

The user authentication helps prevent the repudiation issue by managing user identification and prevents information disclosure and device integrity issues by unauthorized users.

These security capabilities help enforce authorizations assigned to users, segregation of duties and least rights:

- User authentication is used to identify and authenticate software processes and devices managing accounts
- Device Password policy and password strength configurable using SoMove and DTM
- Authorization managed according to channels
- User account lockouts configurable with number of unsuccessful login attempts

In line with user authentication and authorization, the device has access control cryptographic features to check user credential before access is granted to the system.

In the ATS430, the control of accessibility to the settings, parameters, configuration, and logging database is done with a user authentication after "Log in", with a name and password.

The ATS430 controls the access through SoMove DTM

## Port Hardening

The communication ports of the ATS430 can be disabled. Logical ports can be enabled/disabled. Port hardening configuration can be set from SoMove DTM with the ADMIN or SecAdmin right.

## Security Event Logging

The security event logging prevents the repudiation issues by ensuring traceability and detection of any service executed and affecting the security policy of the device.

These security capabilities support the analysis of security events, help protect the device from unauthorized alteration and records configuration changes and user account events:

- Human-readable reports for device security settings
- Audit event logs to identify:
  - The ATS430 security configuration modification
  - The device users' activity (e.g. login, logout)
  - The device firmware updates
  - Audit storage capacity of 500 security event logs
  - Timestamps, including date and time, match ATS430 clock

## ATS430 Security Policy

To facilitate cybersecurity first configurations, the ATS430 offers 2 security policies with preset ATS430 security features. This operation applies default values adapted to the security level targeted by the system of which the device is part.

Selection of these 2 security policies can be done upon first power up of the device, both with the display terminal (Refer to *First Power-Up*, page 101 for more information) and Commissioning tool (DTM).

### Security Policy “Minimum”

This profile offers a minimum of cybersecurity features. The user access control (login & password check at connection) are disabled on SoMove, EcoStruxure Control Expert.

Those connections remain unsecured and open for potential elevation of privilege. This profile is to be used for installation where authentication & authorization constraints are covered by access control mitigation external to the device.

When Minimum policy is selected, each user accessing the device is considered to have limited privileges.

### Security Policy “Advanced”

This profile presets the device security by enabling security features. The user access control is enabled for SoMove, EcoStruxure Control Expert.

When activating the “Advanced” security policy, the user is identified as ADMIN and is requested to create a password unique to the device.

A default password is displayed on the display terminal. It is mandatory to be changed on the first connection.

To apply the “Advanced” security policy, perform the procedure described in the step by step, page 102.

Further configuration can be done using Commissioning tool (DTM).

Refer to the following cybersecurity features summary per security policy:

ATS430 security feature	Open for configuration (activation or settings)	Preset security policy	
		Minimum	Advanced
Password encrypted in a non-reversible way	-	-	✓
User access control	-	-	✓
Cryptographic signature of firmware package	-	✓	✓
Secure root of trust	-	✓	✓
Device backup	ADMIN or SecAdmin only	-	✓
Device restore	ADMIN or SecAdmin only	✓	✓
Security Save	ADMIN or SecAdmin only	-	✓
Security Restore	ADMIN or SecAdmin only	✓	✓
User management	ADMIN or SecAdmin only	-	✓
Strong password/pin code policy	ADMIN or SecAdmin only	-	✓
Brute force and session timeout	ADMIN or SecAdmin only	-	✓
System use notification	ADMIN or SecAdmin only	-	✓
Access control: <ul style="list-style-type: none"> <li>• Commissioning tools (Modbus Serial)</li> <li>• Display terminal</li> </ul>	For all users	✓	✓
Secure events recorded	ADMIN or SecAdmin only	✓	✓
Port hardening	ADMIN or SecAdmin only	-	✓

## Import / Export Security Policy

The device security settings can be exported from a device to be archived and/or applied in the same or another device. The result of a security policy export consists in the creation of a security policy file. This file is identified with the extension .secp.

The following table describes the security settings included in the security policy export:

Security settings	Included in import / export operation
User access control settings	✓
Password & Pin code policy, including session lock and user account lockout configuration	✓
User database, including username, password, pin codes and roles	✓
Password history	✓
Ports and Service management, Brute force mitigation and session timeout, system use notification	✓
Device default password	For security reasons, the default password is unique to each device and cannot be exported.
Security events	The security events base is private property of a device and cannot be applied to another device.

**NOTE:** When a security configuration file is loaded, please restart the device.

## Potential Risks and Compensating Controls

Address potential risks using these compensating controls:

Area	Issue	Risk	Compensating controls
User accounts.	Default account settings are often the source of unauthorized access by malicious users.	If you do not change default password or disable the user access control, unauthorized access can occur.	Ensure User access control is enabled on all the communication ports and change the default passwords to help reduce unauthorized access to your device.
Secure protocols.	The device does not have the capability to transmit data encrypted using the Modbus Serial protocol.	If a malicious user gained access to your network, they could intercept communication.	For transmitting data over internal network, physically or logically segment your network.  For transmitting data over external network, encrypt protocol transmissions over all external connections using an encrypted tunnel, TLS wrapper or a similar solution.  See <a href="#">Protected Environment Assumptions</a> .

## Data Flow Restriction

For detailed information, refer to the TVDA: How Can I Reduce Vulnerability to Cyber Attacks (STN V3.0).

## Device Recovery and Reconstitution

Control system backup – available and up-to-date backups for recovery from a control system failure.

Available and up-to-date firmware package for recovery from a system disaster. The customer stores the current used firmware version package or the latest up-to-date firmware package available on **se.com**.

Both Control System backup and firmware package, shall be considered as assets with dedicated risk analysis according to your local Cybersecurity policy. Make sure the access and use of these files are protected by appropriate security controls to ensure the trust, availability and effectiveness of the device's disaster recovery plan.

**NOTE:**

- Complete device recovery can be performed by applying the firmware update package and the device backup image previously stored by the customer.
- In case of a firmware recovery on the product is not possible, please contact your local Schneider Electric representative.

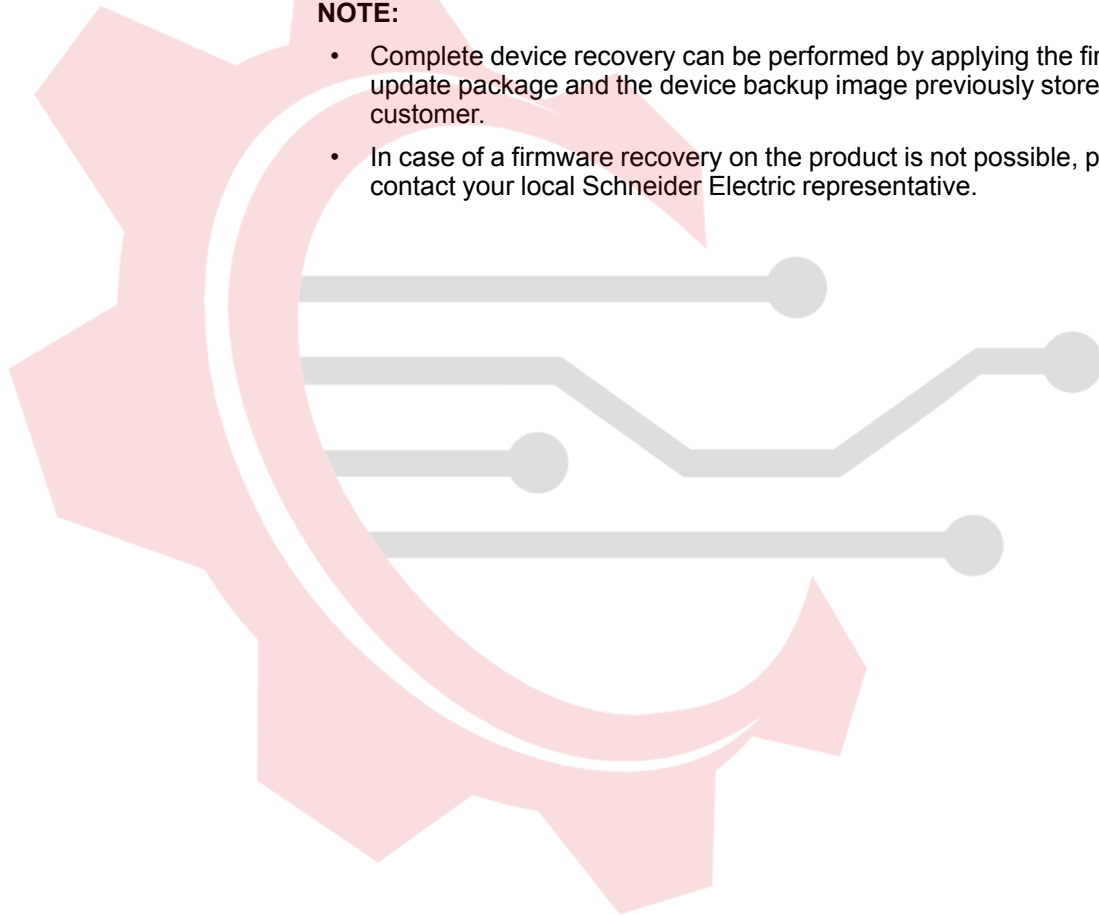

ماکان کنترول

# Inspect, Store and Handle the Product

## What's in This Part

Inspecting the Product .....	59
Storage and Shipping .....	60
Weight And Lifting Lugs Availability.....	62
Unpacking and Hoisting on Pallet .....	63

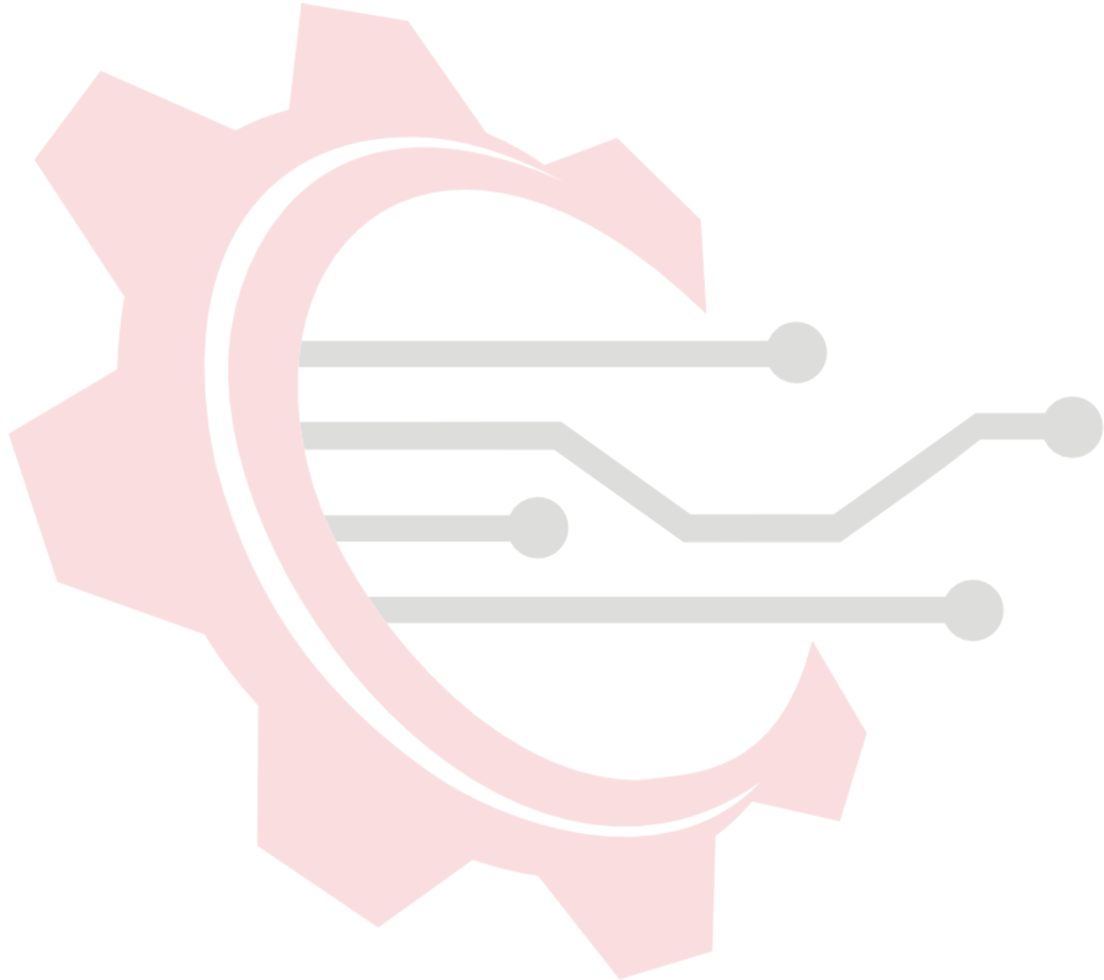

ماکان کنترول

## Inspecting the Product

Unpack the soft starter and verify that it is not damaged.

Damaged products or accessories may cause electric shock or unanticipated equipment operation.

### **⚠️⚠️ DANGER**

#### **ELECTRIC SHOCK OR UNANTICIPATED EQUIPMENT OPERATION**

Do not use damaged products or accessories.

**Failure to follow these instructions will result in death or serious injury.**

Contact your local Schneider Electric sales office if you detect any damage whatsoever.

Step	Action
1	Verify that the reference number printed on the nameplate corresponds to the purchase order.
2	Before performing any installation work inspect the product for visible damage.

Store the product in its original packaging if not installed immediately after inspection.

ماکان کنترول

## Storage and Shipping



### NOTICE

#### INCORRECT STORAGE

Do not crush the packaging during transport and storage.

**Failure to follow these instructions can result in equipment damage.**

Refer to the stacking instructions on the packaging. The environment during transportation and storage must be dry and free from dust.

	IEC Standard	Transport and Storage
Ambient temperature		-40...70° C (-40...158 °F)
Relative humidity	IEC 60068–2–3	Maximum 93 % without condensation or dripping water
Vibration resistance	IEC 60068–2–6	<ul style="list-style-type: none"> <li>• Transport : 2M5</li> <li>• Storage : 1M11</li> </ul>
Shock resistance	IEC 60068–2–27	100 m/s <sup>2</sup> (10 g) during 11 ms

For more information refer to Major Characteristics, page 19.

If the soft starter must be shipped to another location, use the original shipping material.

### ⚠ WARNING

#### INCORRECT HANDLING

- Lifting and handling must be performed by qualified personnel in accordance with the requirements of the site and in compliance with all pertinent regulations.
- Verify that there are no persons or obstructions in the area of operation of the lifting and handling equipment.
- Use lifting and handling equipment appropriate for the load and take all necessary measures to avoid swinging, inclination, toppling and any other potentially hazardous conditions.
- Follow all handling instructions provided in this manual and in all associated product documentation.
- Take all measures required to avoid damage to the product and other hazards when handling or opening the packaging.
- Handle and store the product in its original packaging.
- Do not handle and store the product if the packaging is damaged or appears to be damaged.

**Failure to follow these instructions can result in death, serious injury, or equipment damage.**

To help protect the product before installation, handle and store it in its packaging.

Ensure that the specified ambient conditions are followed.

**▲ WARNING****SHARP EDGES**

Use all necessary personal protective equipment (PPE) such as gloves when performing any type of work whatsoever on or with this product.

**Failure to follow these instructions can result in death, serious injury, or equipment damage.**

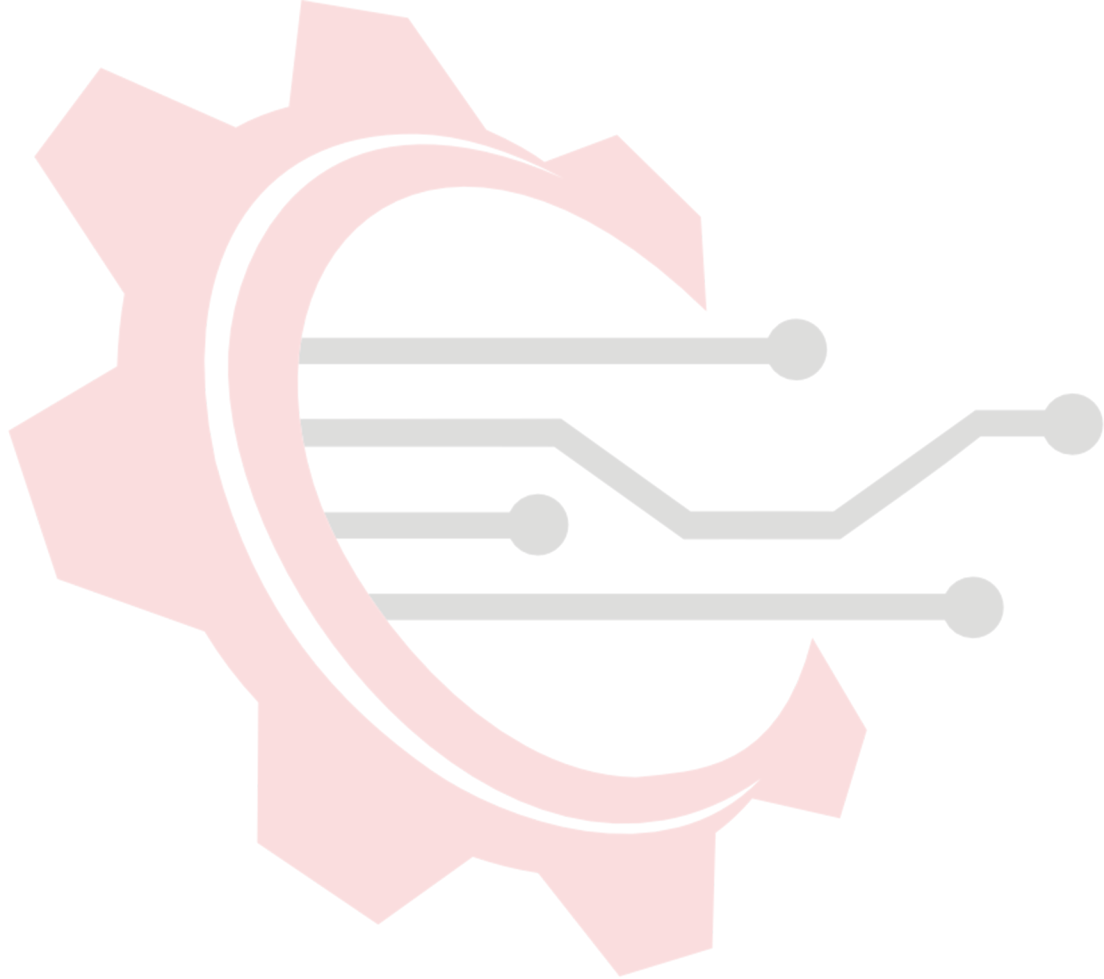

ماكان كنترول

## Weight And Lifting Lugs Availability

See the weights, lifting lugs availability and packaging types in the following table before installing the soft starter.

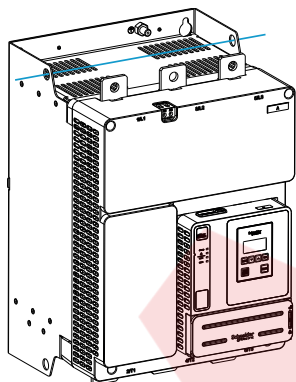

References	Weight kg (lbs)	Lifting lugs	Packaging
ATS430D17S6...D32S6	2.9 (6.4)	No	Cardboard box
ATS430D47S6	3.4 (7.5)	No	Cardboard box
ATS430D62S6	6.4 (14.1)	No	Cardboard box
ATS430D75S6...C11S6	6.6 (14.5)	No	Cardboard box
ATS430C14S6...C17S6	8.6 (19)	No	Cardboard box
ATS430C21S6...C41S6	16.5 (36,4)	Yes	Pallet
ATS430C48S6...C59S6	24.5 (54)	Yes	Pallet

ماکان کنترول

## Unpacking and Hoisting on Pallet

For ATS430C41S6 to ATS430C59S6, consider this additional safety message:

### ⚠ WARNING

#### TIPPING

- Take into account the high center of gravity when handling the equipment.
- Only transport the equipment on the pallet using a suitable forklift.
- Do not remove the straps and the screws on the pallet before the equipment has been transported to the final installation position.

**Failure to follow these instructions can result in death, serious injury, or equipment damage.**

### ⚠ WARNING

#### SHARP EDGES

Use all necessary personal protective equipment (PPE) such as gloves when performing any type of work whatsoever on or with this product.

**Failure to follow these instructions can result in death, serious injury, or equipment damage.**

### ⚠ WARNING

#### TOPPLING, SWINGING, OR FALLING EQUIPMENT

- Take all measures necessary to keep the equipment from swinging, toppling and falling.
- Follow the instructions provided to remove the equipment from the packaging and to mount it at its final position.

**Failure to follow these instructions can result in death, serious injury, or equipment damage.**

ماكان كنترول

See the procedure for hoisting the product references from ATS430C21S6 to ATS430C59S6:

Step	Action
1	Lift the soft starter by means of a hoist by using the handling lugs of the soft starter to fasten the lifting equipment. The lifting bar is not supplied.
2	Keep the soft starter suspended by means of appropriate equipment until it is securely fastened in the final installation position.
3	Move the soft starter to the final installation or on the back of the enclosure.

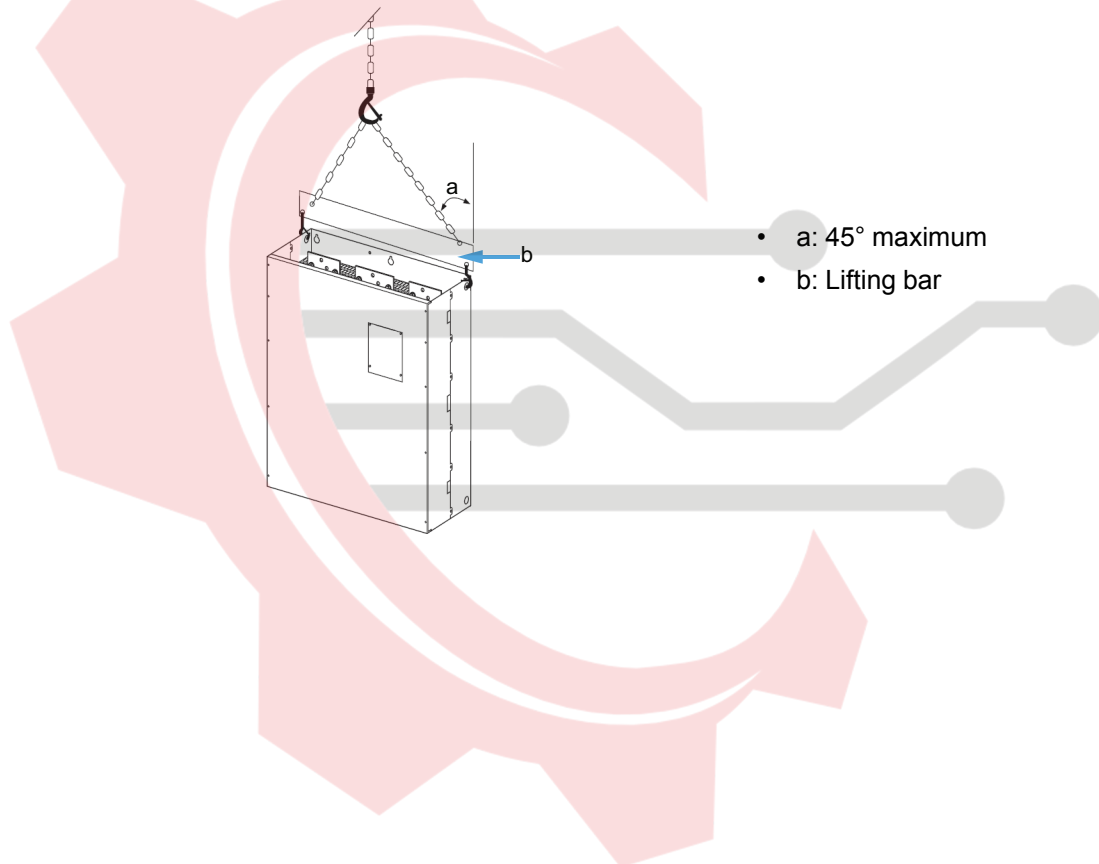

ماکان کنترول

# Installation

## What's in This Part

Electronic product data sheet .....	66
Mounting the ATS430 .....	67
Installing Door Mounting Kit .....	69
Wiring.....	70
Checking Installation .....	81

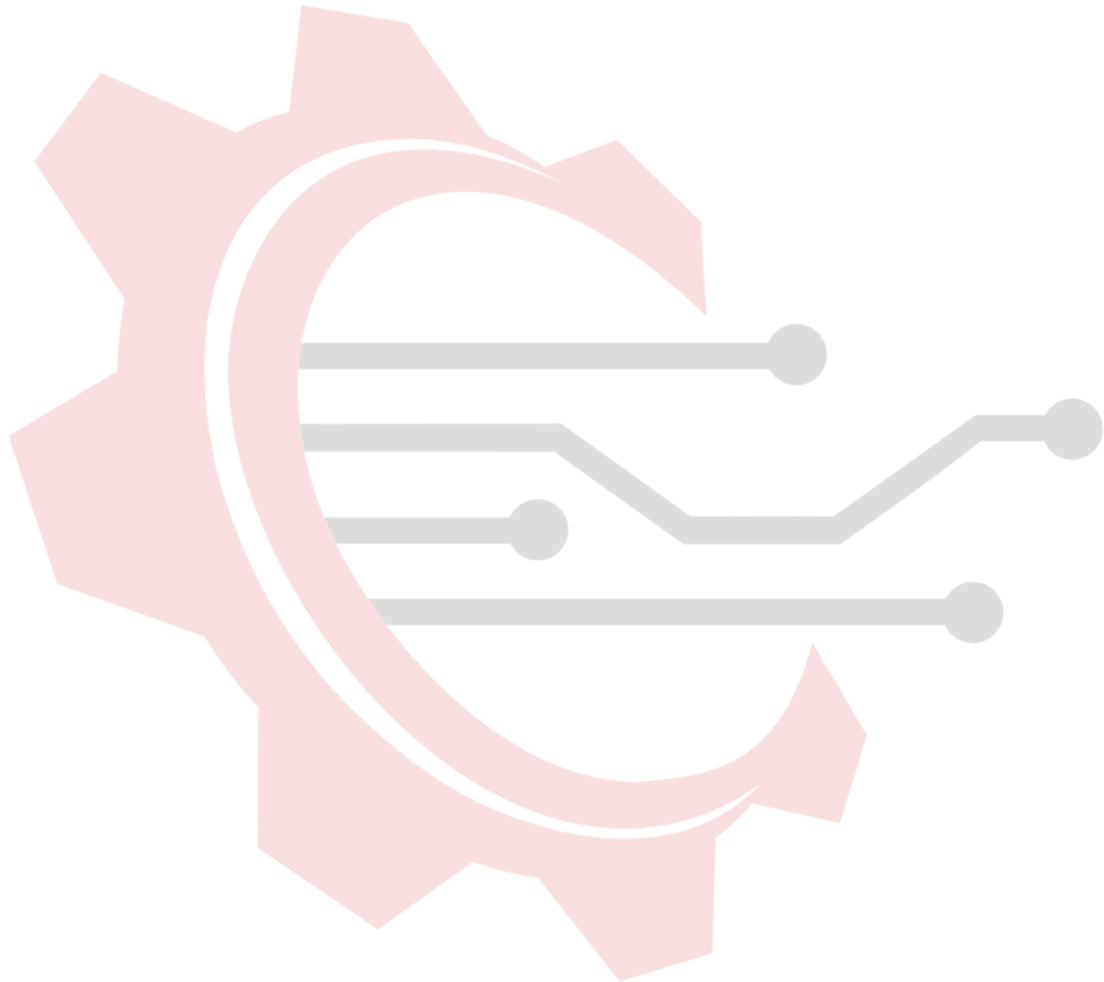

ماکان کنترول

# Electronic product data sheet

Scan the QR code in front of the soft starter to get the product data sheet.

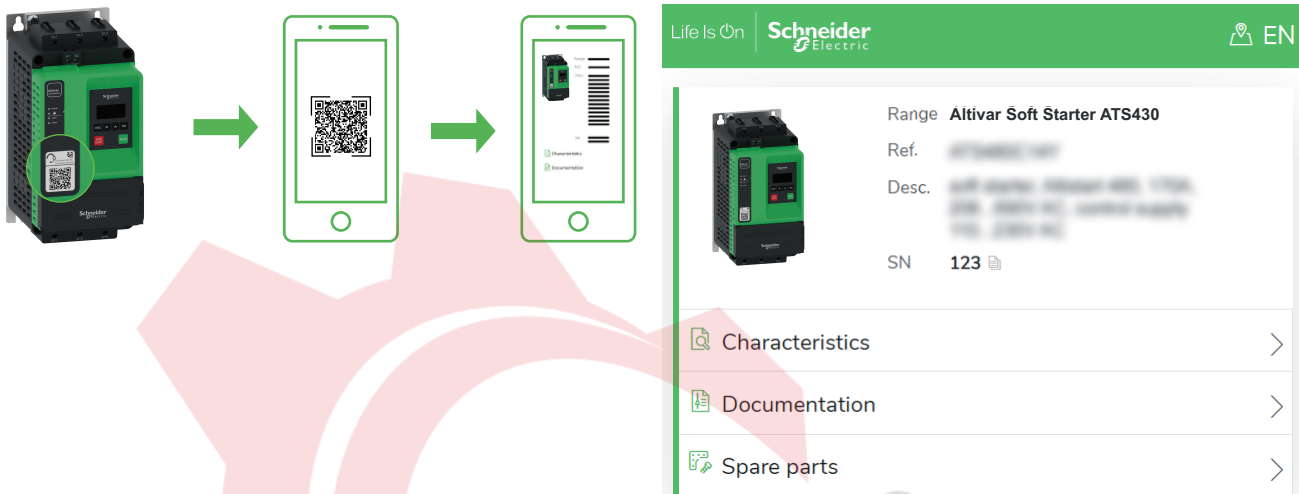

The diagram illustrates the process of scanning a QR code on a soft starter to access its product data sheet. It shows a physical soft starter unit, a smartphone scanning the QR code, and a screenshot of the resulting product data sheet.

The screenshot of the product data sheet shows the following information:

- Range: **Altivar Soft Starter ATS430**
- Ref.:
- Desc.:
- SN: **123**

The data sheet also includes links to:

- Characteristics
- Documentation
- Spare parts

Scanning the QR Code gives you access to :

- Product ID Card : Product range, Reference, short description and a Serial Number (Use the serial number to retrieve the product's manufacturing date).  
About the Serial Number, refer to Manufacturing Date, page 255.
- The product characteristics : Main characteristics, environment, packing units, sustainability...
- Documentation : Technical Guidance at Glance (Presentation, Dimensions, Mounting, Wiring, Commissioning...) and Product Documentation (User guide, Instructions sheets, Certificates, How To videos...)
- Spare parts for your product

ماکان کنترول

# Mounting the ATS430

## Mounting position

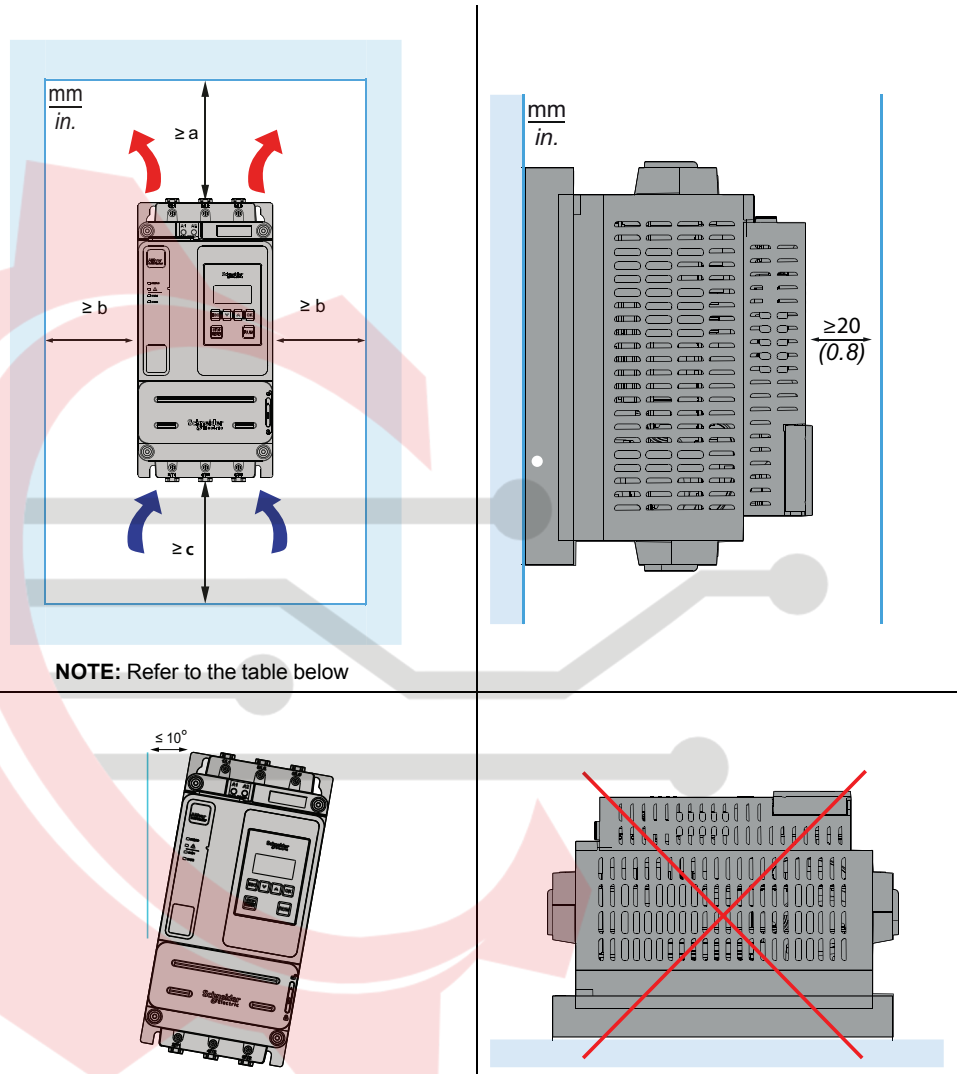

NOTE: Refer to the table below

References	Minimum free space above the Soft Starter (a)	Minimum free space on the sides of the Soft Starter (b)	Minimum free space below the Soft Starter (c)
	mm (in)	mm (in)	mm (in)
ATS430D17S6...D47S6	100 (4)	10 (0.4)	100 (4)
ATS430D62S6...C17S6	75 (3)	10 (0.4)	60 (2.4)
ATS430C21S6...C41S6	85 (3.4)	10 (0.4)	60 (2.4)
ATS430C48S6...C59S6	100 (4)	20 (0.8)	75 (3)

## Fixing the ATS430

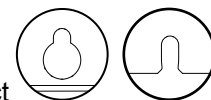

Check the position of the fixing holes on the product

Use screws with DIN 125 washer to mount the soft starter. Tighten the fixing screws.

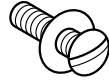

ATS Reference	Mounting Screw Size
ATS430D17S6...ATS430C17S6	M6
ATS430C21S6...ATS430C41S6	M8
ATS430C48S6...ATS430C59S6	M10



ماكان كنترول

# Installing Door Mounting Kit

The ATS430 has an embedded Display Terminal

The VW3A1111 Graphic Display Terminal and the VW3A1113 Plain Text Display Terminal are available as options to replace the embedded Display Terminal.

Door mounting kits are available as options to mount the display terminal on the door of the enclosure.

Refer to the following table to choose a display terminal and its door mounting kit.

Door Mounting Kit protection degree	Display terminal	Door mounting kit
IP43	VW3A1113 Plain Text Display Terminal <b>Available as option</b> 	VW3A1114 door mounting kit. <b>Available as option</b>  Refer to the instruction sheet EAV91355.
IP65	VW3A1111 Graphic Display Terminal <b>Available as option</b> 	VW3A1112 door mounting kit. <b>Available as option</b>  Refer to the instruction sheet EAV76406.
Select one of the following RJ45 cables to connect the remote mounting kit to the soft starter: <ul style="list-style-type: none"> <li>• 1 meter: VW3A1104R10</li> <li>• 3 meters: VW3A1104R30</li> </ul> <b>Not included with the remote kit</b>		

# Wiring

## What's in This Chapter

Wiring the Power Part for ATS430D17S6...ATS430C11S6..... 73  
 Wiring the Power Part for ATS430C14S6...ATS430C59S6..... 75  
 Wiring the Control Terminals ..... 78

## General instructions

**⚡⚠ DANGER**

**HAZARD OF ELECTRIC SHOCK, EXPLOSION OR ARC FLASH**

Read and understand the instructions in **Product Related Information** chapter before performing any procedure in this chapter.

**Failure to follow these instructions will result in death or serious injury.**

**⚡⚠ DANGER**

**HAZARD OF FIRE OR ELECTRIC SHOCK**

- Wire cross sections and tightening torques must comply with the specifications provided in this document.
- If you use flexible multi-wire cables for a connection with a voltage higher than 25 Vac, you must use ring type cable lugs or wire ferrules, depending on the wire gauge and the specified stripping length of the cable.

**Failure to follow these instructions will result in death or serious injury.**

The product has a leakage current greater than 3.5 mA. If the protective ground connection is interrupted, a hazardous touch current may flow if the product is touched.

**⚡⚠ DANGER**

**ELECTRIC SHOCK CAUSED BY HIGH LEAKAGE CURRENT**

Verify compliance with all local and national electrical code requirements as well as all other applicable regulations with respect to grounding of the entire installation.

**Failure to follow these instructions will result in death or serious injury.**

**⚡⚠ DANGER**

**INSUFFICIENT PROTECTION AGAINST SHORT CIRCUIT AND OVERCURRENTS CAN CAUSE FIRE OR EXPLOSION**

- Use properly rated Short Circuit Protection Devices (SCPD).
- Use the fuses/circuit breakers specified.

**Failure to follow these instructions will result in death or serious injury.**

**⚠️⚠️ DANGER****HAZARD OF ELECTRIC SHOCK, EXPLOSION, OR FIRE**

The opening of the branch-circuit protective device is able to be an indication that a fault current has been interrupted.

- Current-carrying parts and other components of the controller should be examined and replaced if damaged.
- If burnout of the current element of an overload relay occurs, the complete overload relay must be replaced.

**Failure to follow these instructions will result in death or serious injury.**

Product may perform unexpected movements because of incorrect wiring, incorrect settings, incorrect data or other errors.

**⚠️ WARNING****UNANTICIPATED EQUIPMENT OPERATION**

- Carefully install the wiring in accordance with the EMC requirements.
- Do not operate the product with unknown or unsuitable settings or data.
- Perform a comprehensive commissioning test.

**Failure to follow these instructions can result in death, serious injury, or equipment damage.**

Refer to the following instructions to wire the soft starter:

- Do not route signal cables next to power cables.
- Cables connected to the motor must have the maximum possible separation from all other power cables. Do not run them in the same conduit. This separation reduces the possibility of coupling electrical noise between circuits.
- Voltage and frequency specifications for the supply mains must match the soft starter configuration.
- A disconnection switch must be installed between the supply mains and the soft starter.
- Power factor correction capacitors should not be connected to a motor controlled by a soft starter. If power factor correction is required, the capacitors must be located on the mains of the soft starter. A separate contactor should be used to switch the capacitors off when the motor is off, or during acceleration and deceleration. Use the relay R2 or a DQ (with an external device) assign to **[End Of Start]** to switch the contactors.
- The soft starter must be grounded to conform to the regulations concerning leakage currents. If the installation involves several soft starters on the same supply mains, each soft starter must be grounded separately.

## Equipment Grounding

### ⚡⚠ DANGER

#### ELECTRIC SHOCK CAUSED BY INSUFFICIENT GROUNDING

- Verify compliance with all local and national electrical code requirements as well as all other applicable regulations with respect to grounding of the entire device.
- Ground the device before applying voltage.
- The cross section of the protective ground conductor must comply with the applicable standards.
- Do not use conduits as protective ground conductors; use a protective ground conductor inside the conduit.
- Do not consider cable shields to be protective ground conductors.

**Failure to follow these instructions will result in death or serious injury.**

## Connection Instructions

The product has a leakage current greater than 3.5 mA. If the protective ground connection is interrupted, a hazardous touch current may flow if the product is touched.

### ⚡⚠ DANGER

#### ELECTRIC SHOCK CAUSED BY HIGH LEAKAGE CURRENT

Verify compliance with all local and national electrical code requirements as well as all other applicable regulations with respect to grounding of the entire installation.

**Failure to follow these instructions will result in death or serious injury.**

- Ensure that the resistance to Ground is 1 Ohm or less.
- When grounding several soft starters, you must connect each one directly, as shown in the above figure.
- Do not loop Ground cables or connect them in series.

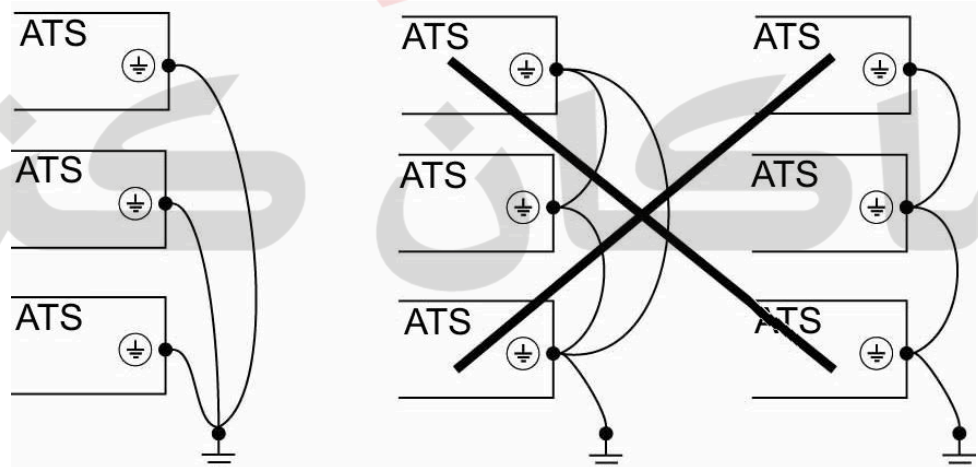

## Wiring the Power Part for ATS430D17S6...ATS430C11S6

Mains side

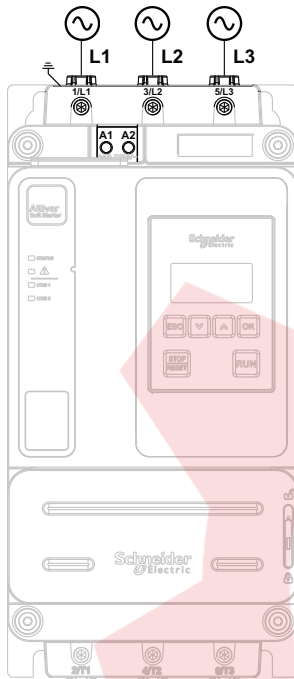

Motor side (bottom)

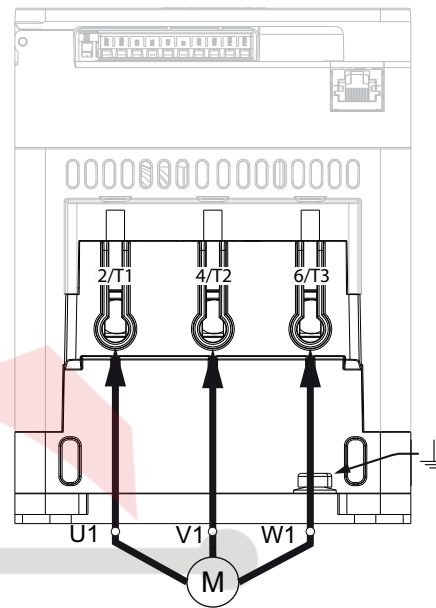

Use class C cables for the power connections.

- 1/L1, 3/L2, 5/L3: Mains supply inputs
- 2/T1, 4/T2, 6/T3: Outputs to motor
- $\perp$  : Ground connection

Simple diagram for the power connections available at Connection In line, page 21.

Complete application diagrams including power and control connections are available at Application Diagrams, page 34.

### Ground Connection Characteristics

References	Section	Tightening torque	Screw size
	mm <sup>2</sup> (AWG)	N.m (lbf.in)	
ATS430D17S6...D47S6	10 (8)	5 (44)	H10
ATS430D62S6...C11S6	16 (6)	5 (44)	

## Recommended Wire cross section

References	Power connectors 1/L1, 3/L2, 5/L3, 2/T1, 4/T2, 6/T3	
	Recommended Wire cross section (a)	
	For current level at 0.4 of the soft starter rating: (b)	For current level at 1 of the soft starter rating:
	mm <sup>2</sup> (AWG)	mm <sup>2</sup> (AWG)
ATS430D17S6	2.5 (12)	2.5 (12)
ATS430D32S6		6 (8)
ATS430D47S6	2.5 (10)	10 (8)
ATS430D62S6	4 (10)	16 (6)
ATS430D75S6	6 (10)	25 (4)
ATS430D88S6	10 (8)	25 (3)
ATS430C11S6		35 (1)

- **(a)** The cross section cable values are given for one cable per cages. The good behavior of the ATS430 is not assured with more than one cable per cages.
- **(b)** The cable gauge affects the IP protection degree. IP20 protection degree requires a minimum cable gauge of 16 mm<sup>2</sup> (4 AWG) and end caps. If this condition is not met, the IP protection degree is IP10.

## Mechanical capacity of terminal blocks, stripping length, tightening torque

References	Power connectors 1/L1, 3/L2, 5/L3, 2/T1, 4/T2, 6/T3				
	Mechanical capacity of terminal blocks		Stripping length		Tightening torque
	mm <sup>2</sup> (AWG)		mm (in)		
	Minimum	Maximum	Minimum	Maximum	N.m (lbf.in)
ATS430D17S6	2.5 (12)	10 (6)	16 (0.6)	18 (0.7)	5 (44)
ATS430D32S6					
ATS430D47S6					
ATS430D62S6	16 (4)	50 (1/0)	16 (0.6)	18 (0.7)	9 (80)
ATS430D75S6					
ATS430D88S6					
ATS430C11S6					

# Wiring the Power Part for ATS430C14S6...ATS430C59S6

Mains side

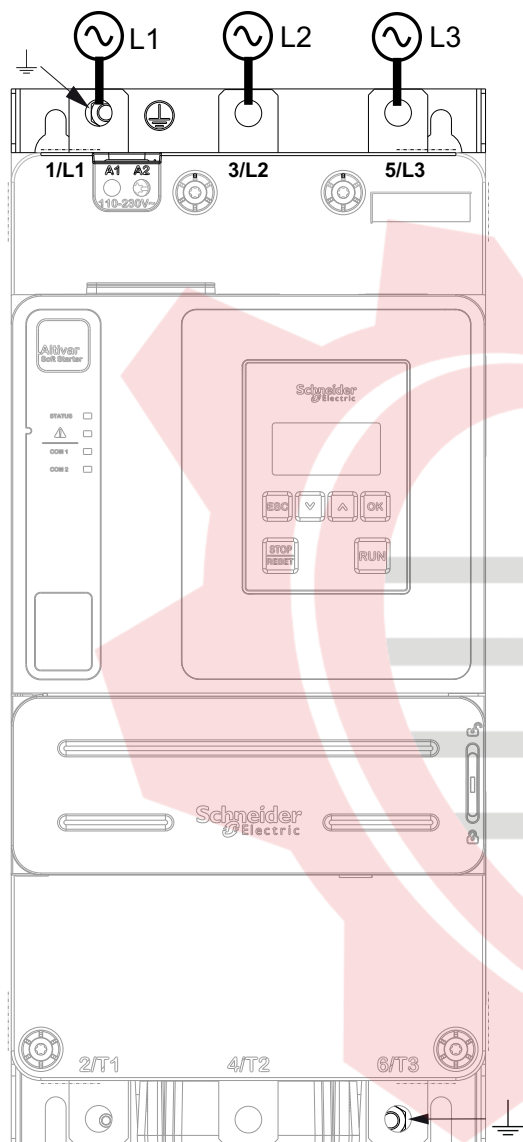

Motor side (bottom)

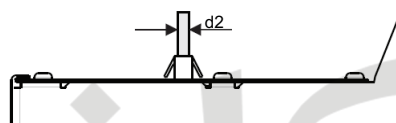
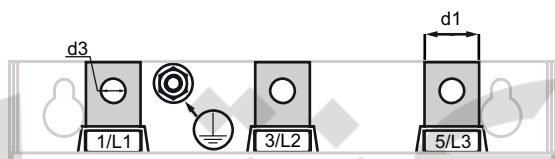
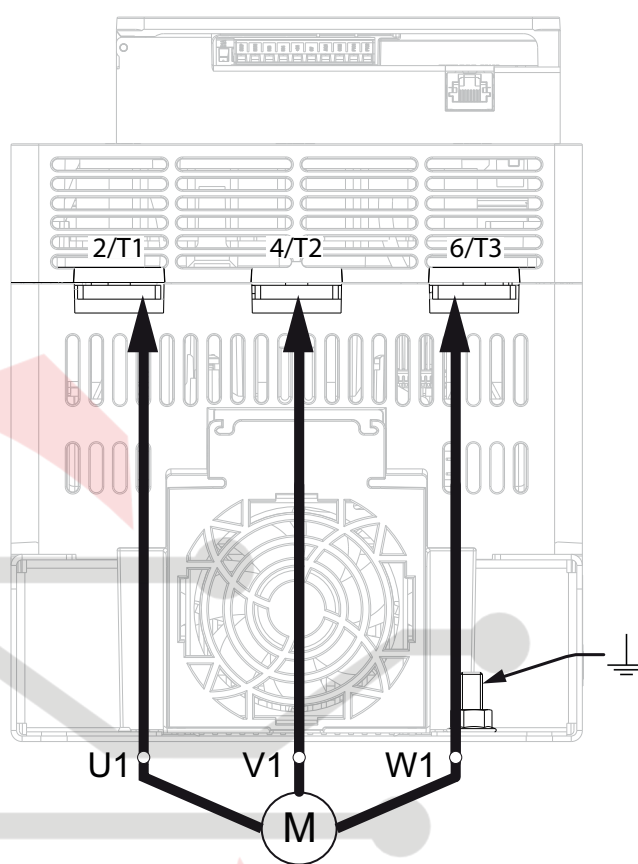

- 1/L1, 3/L2, 5/L3: Mains supply inputs
- 2/T1, 4/T2, 6/T3: Outputs to motor
- ⊥ : Ground connection

Simple diagram for the power connections is available at Connection In line, page 21.

Complete application diagrams including power and control connections are available at Application Diagrams, page 34.

## Ground Connection Characteristics

References	Section	Tightening torque	Screw size
	mm <sup>2</sup> (AWG)	N·m (lbf.in)	
ATS430C14S6...C17S6	35 (4)	5 (44)	H10
ATS430C21S6...C41S6	150 (0)	12 (106)	H13
ATS430C48S6...C59S6	185 (2/0)	24 (212)	H16

## Recommended wire cross section

References	Power connectors 1/L1, 3/L2, 5/L3, 2/T1, 4/T2, 6/T3	
	Section mm <sup>2</sup> (AWG)	
	For current level at 0.4 of the soft starter rating:	For current level at 1 of the soft starter rating:
ATS430C14S6	16 (6)	50 (2/0)
ATS430C17S6	25 (4)	70 (3/0)
ATS430C21S6	25 (4)	95 (4/0)
ATS430C25S6	35 (3)	120 (250 kcmil)
ATS430C32S6	50 (1)	185 (400 kcmil)
ATS430C41S6	70 (2/0)	2x150 (2x250 kcmil)
ATS430C48S6	95 (3/0)	
ATS430C59S6	120 (250 kcmil)	2x185 (2x350 kcmil)

## Bar characteristics and tightening torque

References	Power connectors 1/L1, 3/L2, 5/L3, 2/T1, 4/T2, 6/T3			
	Bar			Tightening torque
	d1 mm (in)	d2 mm (in)	d3 mm (in)	N.m (lbf.in)
ATS430C14S6	20 (0.8)	3 (0.1)	9 (0.4)	12 (106)
ATS430C17S6				
ATS430C21S6	30 (1.1)	5 (0.2)	13,5 (0.6)	44 (389)
ATS430C25S6				
ATS430C32S6				
ATS430C41S6				
ATS430C48S6	40 (1.6)			
ATS430C59S6				

## Special case of Aluminum cables:

The use of aluminum field wiring cables is allowed on ATS430 from ATS430C14S6 to ATS430C59S6 with limitation.

In case of usage of terminal protection kits, the cross section of aluminum cable may be incompatible with the protection kit capacity and can cause equipment damage or impossible mounting.

### **⚠ DANGER**

#### **HAZARD OF FIRE OR/AND TERMINALS OVERHEATING**

- The plating of aluminum wire termination must only be compatible with the tin plated copper terminals of the product as regards to galvanic corrosion.
- The sizing of the aluminum wires must be made in accordance with the information below<sup>(1)</sup>.
- The sizing of aluminum wire terminations must not exceed the terminal dimension capacity (refer to Power Connections table ).
- Cross sections exceeding the terminal dimension capacity can cause impossible wiring, damage on the terminals or the equipment, or electrical insulation weakness and therefore shall be avoided.
- The tightening torque on aluminum wires termination must be adapted to prevent damage during installation, reduce creeping risk and prevent risk of overheating in operation<sup>(2)</sup>.
- In order to prevent risks from aluminum oxide low conductivity, the aluminum wire termination must be protected against corrosion or not submitted to corrosive substances.

**Failure to follow these instructions will result in death or serious injury.**

**(1)** : Sizing of the aluminum wires minimum cross section based on:

- NFPA70 Table 310.16 considering ambient temperature, insulation type and cable arrangement.
- Or IEC60364–5 considering ambient temperature, insulation type and cable arrangement.
- Or the application sizing standard for aluminum wire in the country of use.

**(1)** : Sizing of the aluminum wires maximum cross section mechanically allowable by the terminal (refer to the User Manual for terminal size information) and is made under the responsibility of the user.

**(2)** : Tightening torque on Aluminum terminals :

- Must be compatible with the acceptable range of the terminal if existing (refer to Power Connections table).
- Must be adapted to the current rating and the surface in contact.
- Is chosen under the responsibility of the user.

## Wiring the Control Terminals

### ⚡⚠ DANGER

#### HAZARD OF FIRE OR ELECTRIC SHOCK

- Wire cross sections and tightening torques must comply with the specifications provided in this document.
- If you use flexible multi-wire cables for a connection with a voltage higher than 25 Vac, you must use ring type cable lugs or wire ferrules, depending on the wire gauge and the specified stripping length of the cable.

**Failure to follow these instructions will result in death or serious injury.**

When the soft starter transitions to operating state Fault, the mains contactor must be deenergized.

### ⚠ WARNING

#### UNANTICIPATED EQUIPMENT OPERATION

- Connect the coil of the mains contactor to output relay R1.

**Failure to follow these instructions can result in death, serious injury, or equipment damage.**

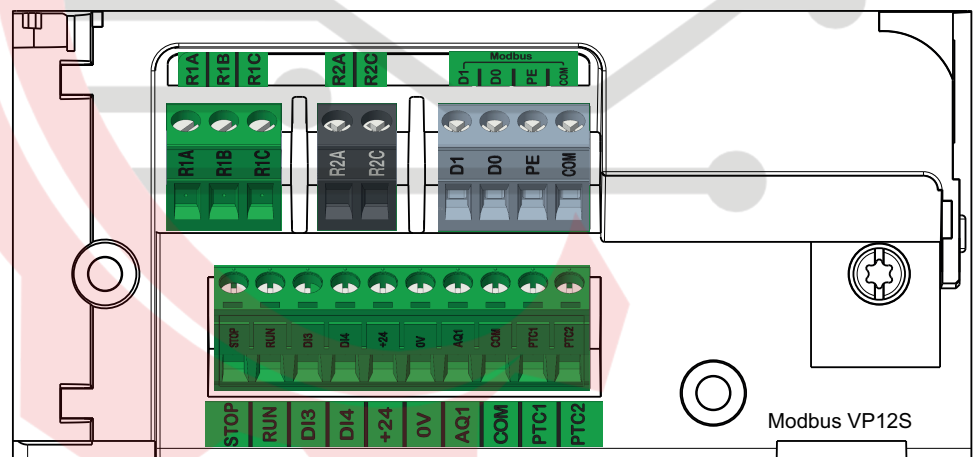

The control terminals are installed with one-way plug-in connectors. Ferrules are mandatory for wiring the A1 and A2 terminals to ensure an IP20 protection. The terminals are approved for stranded conductors and solid conductors. Use wire cable ends (ferrules) if possible.

**NOTE:** Modbus VP12S: This is the standard Modbus serial link marking. VP•S means connector with power supply, where 12 stands for the 12 Vdc supply voltage.

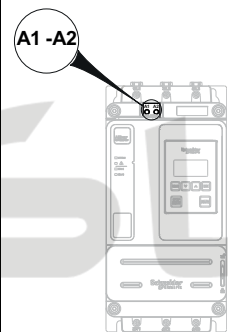

**Control terminal wires specifications :**

Tightening torque max N.m (lbf.in)	Min relay output wire cross section mm <sup>2</sup> (AWG)	Other min wire cross section mm <sup>2</sup> (AWG)	Max connection capacity mm <sup>2</sup> (AWG)	Stripping length mm (in)	
				Min	Max
0.5 (4.4)	0.75 (18)	0.5 (20)	1.5 (16)	5.5 (0.2)	7.5 (0.3)

Those values are given for a single wire per terminal. Use a shunt to create a bridge between terminals if necessary.

**Control supply terminals A1/A2 wires specifications :**

Tightening torque max N.m (lbf.in)	Min wire cross section mm <sup>2</sup> (AWG)	Max connection capacity mm <sup>2</sup> (AWG)	Stripping length mm (in)	
			Min	Max
0.5 (4.4)	0.5 (20)	2.5 (14)	5.5 (0.2)	7.5 (0.3)

**Control terminals function and characteristics**

<b>NOTICE</b>
<p><b>INCORRECT VOLTAGE</b></p> <ul style="list-style-type: none"> <li>• Supply the control supply terminals A1 / A2 within a range of 110...230 Vac only</li> </ul> <p><b>Failure to follow these instructions can result in equipment damage.</b></p>

Terminals	Function	I/O	Characteristics
R1A	R1A — R1C : NO	O	<ul style="list-style-type: none"> <li>• Max voltage: 250 Vac.</li> <li>• Min. switching capacity: 10 mA for 24 Vdc</li> <li>• Max. switching capacity on inductive load following IEC60947-2:                             <ul style="list-style-type: none"> <li>◦ 2A/250Vac for AC15 100 000 cycles</li> <li>◦ 2A/30Vdc for DC13 150 000 cycles</li> </ul> </li> </ul> Inductive load must be equipped with a voltage surge suppression device according to AC or DC operation with total energy dissipation greater than the inductive energy stored in the load.  Refer to sections Output Relay with Inductive AC Loads, page 43 and Output Relay with Inductive DC Loads, page 44.
R1B	R1B — R1C : NC		
R1C	Programmable relay R1 – Assigned to Operating state Fault by default		
R2A	NO relay R2 – Assigned to End of starting. Will close when the soft starter is in established regime.	O	
R2C			
D0	Serial link based on 2–wire Modbus over serial line electrical interface.	I/O	
D1			
PE	Protective Earth connection	I/O	
COM	I/O common	I/O	

Terminals	Function	I/O	Characteristics
STOP	Digital Input 1 — Assigned to STOP	I	<ul style="list-style-type: none"> <li>• 4 x 24 Vdc digital inputs with 4.4 k<math>\Omega</math> impedance</li> <li>• U<sub>max</sub> = 30 V</li> <li>• I<sub>max</sub> = 7 mA</li> <li>• State 1: U &gt; 11 V and I &gt; 5 mA</li> <li>• State 0: U &lt; 5 V and I &lt; 2 mA</li> <li>• Response time: 2 ms <math>\pm</math> 0.5 ms max</li> </ul>
RUN	Digital Input 2 — Assigned to RUN	I	
DI3	Digital Input 3	I	
DI4	Digital Input 4	I	
0V	Common for +24	I/O	<ul style="list-style-type: none"> <li>• 0 V</li> </ul>
+24	Supply for digital output	I/O	<ul style="list-style-type: none"> <li>• U<sub>min</sub>: 19 Vdc</li> <li>• U<sub>nominal</sub>: 24 Vdc</li> <li>• U<sub>max</sub>: 30 Vdc</li> <li>• I<sub>max</sub>: 200 mA</li> <li>• Isolated and protected against short-circuits and overloads, maximum current 200 mA.</li> <li>• Can be used to supply the control block with an external 24Vdc supply if A1 and A2 are absent to keep communication with the product</li> </ul> <p><b>NOTE:</b> The +24 terminal does not entirely substitute supply from A1 and A2. The motor cannot be controlled if you supply the ATS430 via only the +24 terminal. To control the motor, the ATS430 must be supplied via A1 and A2.</p>
AQ1	Programmable analog Output 1	O	<ul style="list-style-type: none"> <li>• Available signal: <ul style="list-style-type: none"> <li>0 —10 Vdc. Minimum load impedance 470 <math>\Omega</math></li> <li>0 —20 mA ; 4 —20 mA, can be configured to custom value. Maximum load impedance 500 <math>\Omega</math></li> </ul> </li> <li>• Accuracy <math>\pm</math> 1% for temperature range —10 to +60°C</li> <li>• Resolution: 10 bits</li> <li>• Linearity: <math>\pm</math> 0.2%</li> <li>• Sampling time: 5 ms + 1 ms maximum</li> </ul>
COM	I/O common	I/O	<ul style="list-style-type: none"> <li>• 0 V</li> </ul>
PTC1	Motor thermal sensor connection	I	<ul style="list-style-type: none"> <li>• Configurable for PTC</li> <li>• Total resistance of sensor circuit 750 <math>\Omega</math> at 25°C</li> <li>• Overheat trigger threshold: 2.9 k<math>\Omega</math> <math>\pm</math> 0.2 k<math>\Omega</math></li> <li>• Overheat reset threshold: 1.575 k<math>\Omega</math> <math>\pm</math> 0.75 k<math>\Omega</math></li> <li>• Threshold for low impedance detection: 50 <math>\Omega</math> —10 <math>\Omega</math>/+20 <math>\Omega</math></li> <li>• Protected for low impedance &lt; 1000 <math>\Omega</math></li> </ul> <p>Refer to <b>[Thermal monitoring]</b> TPP, page 132 for more information on thermal sensors.</p>
PTC2			

# Checking Installation

## Check List: Before Switching On

Unsuitable settings or unsuitable data or unsuitable wiring may trigger unintended movements, trigger signals, damage parts and disable monitoring functions.

<b>▲ WARNING</b>
<p><b>UNANTICIPATED EQUIPMENT OPERATION</b></p> <ul style="list-style-type: none"> <li>• Only start the system if there are no persons or obstructions in the zone of operation.</li> <li>• Verify that a functioning emergency stop push-button is within reach of all persons involved in the operation.</li> <li>• Do not operate the product with unknown settings or data.</li> <li>• Verify that the wiring is appropriate for the settings.</li> <li>• Never modify a parameter unless you fully understand the parameter and all effects of the modification.</li> <li>• When commissioning, carefully run tests for all operating states, operating conditions and potential error situations.</li> <li>• Anticipate movements in unintended directions or oscillation of the motor.</li> </ul> <p><b>Failure to follow these instructions can result in death, serious injury, or equipment damage.</b></p>

## Check List: Mechanical Installation

Verify the mechanical installation of the entire soft starter system:

Step	Action	✓
1	Does the installation meet the specified distance requirements?	
2	Did you tighten all fastening screws according to the specified tightening torque?	

ماکان کنترول

## Check List: Electrical Installation

Verify the electrical connections and the wiring:

Step	Action	✓
1	Did you connect all protective Ground conductors?	
2	The correct tightening of the screws may be altered during assembly and wiring phases of the soft starter. Verify and adjust the tightening of all terminal screws to the specified nominal torque.	
3	Do all fuses and circuit breaker have the correct rating; are the fuses of the specified type? Refer to the information provided in the catalog.	
4	Did you connect or insulate all wires at the cable ends?	
5	Did you properly separate and insulate the control and power wiring?	
6	Did you properly connect and install all cables and connectors?	
7	Did you properly connect the signal wires?	
8	Are the required shield connections EMC-compliant?	
9	Did you take all measures for EMC compliance?	
10	Did you confirm that A1/A2 terminals are only supplied with 110...230 Vac?	
11	Did you confirm that the output of the relays R1 and R2 are only connected to a maximum voltage of 250Vac / 30Vdc?	

## Check List: Covers and Seals

Verify that all devices, doors and covers of cabinet are properly installed to meet the required degree of protection.

ماکان کنترول

## Product HMI

### What's in This Part

Front Product LEDs .....	84
Display Terminals .....	85
Configure the display terminal .....	89



ماکان کنترول

## Front Product LEDs

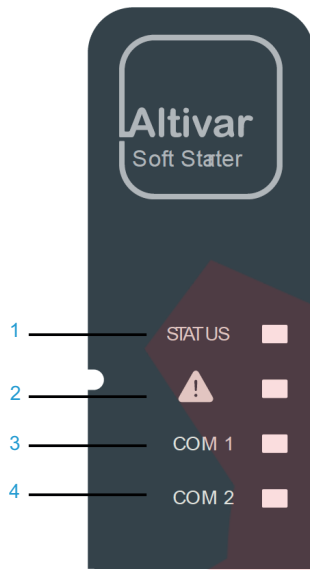

Item	LED	Description
1	<b>STATUS</b>	Bicolor Green/Yellow LED indicating soft starter states
2	<b>Warning/Error</b>	Red LED indicating whether a warn/error is active. It is in addition to warn/error info display on Display terminal LCD
3	<b>COM 1</b>	Yellow LED indicating Modbus serial activity on port RJ45 Modbus VP
4	<b>COM 2</b>	Yellow LED indicating Open-Style Modbus activity.

ماکان کنترول

# Display Terminals

## Embedded Display Terminal

This Embedded Display Terminal is a local control unit embedded in the soft starter. The embedded Modbus connection can be used to connect a second Display Terminal, consequently the Embedded Display Terminal is deactivated.

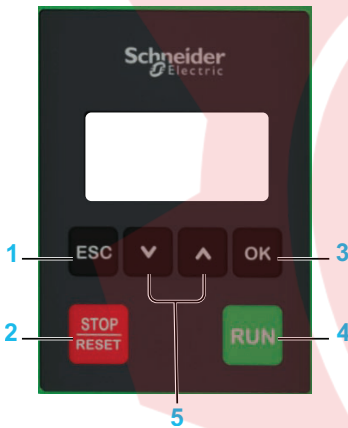

1. **ESC**: used to access main menu (press successively), to quit a menu/parameter, to clear the display of the triggered error or remove the currently displayed value in order to revert to the previous value retained in the memory
2. **STOP / RESET**: stop command (not active when an external display terminal is connected)/ apply a Fault Reset (a).
3. **OK**: used to save the current value (long press for alphanumeric values or multi fields) or access the selected menu/parameter.
4. **RUN**: executes the function (a).
5. **UP / DOWN**: used for selections, shift between alphanumeric values and increment/decrement numeric values.

(a) The **RUN** and **RESET** functions are active only if, in the menu **[Complete settings] → [Command channel]** :

- **[Control Mode]** is set to **[Standard Profile]**
- **[Command Switching]** is set to the channel commanding the display terminal

**Example:** Control via display terminal is active when **[Command Switching]** is set to **[Cmd channel 1]** and **[Cmd channel 1]** is set to **[HMI]** .

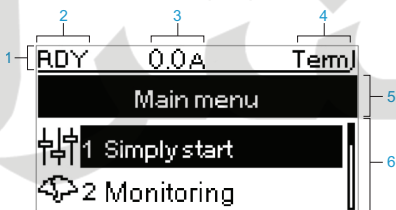

Key	
1	<b>Display line</b>
2	Soft starter state, refer to Soft Starter State, page 259
3	Monitored parameter user defined. Can be configured in <b>[My preferences]</b> .
4	Active control channel <ul style="list-style-type: none"> <li>• TERM: terminals</li> <li>• HMI: embedded display terminal</li> <li>• MDB: embedded Modbus serial</li> <li>• PWS: DTM based commissioning software</li> </ul>
5	<b>Menu line: indicates the name of the current menu or submenu.</b>
6	Menus, submenus, parameters, values, bar charts, and so on, are displayed in drop-down window format on a maximum of 2 lines. The line or value selected by the navigation button is displayed in reverse video.

# Plain Text Display Terminal VW3A1113

This Plain Text Display Terminal is available as an optional Display Terminal, it can be plugged using the Modbus serial link connection, consequently the Embedded Display Terminal is deactivated. The Display Terminal can be removed to be mounted on the door of the wall-mounted or floor-standing enclosure, using a dedicated door-mounting kit, refer to *Installing Door Mounting Kit*, page 69.

**NOTE:** When error **[HMI Com Interruption]** SLF3 is triggered, the active HMI becomes automatically the Embedded Display Terminal.

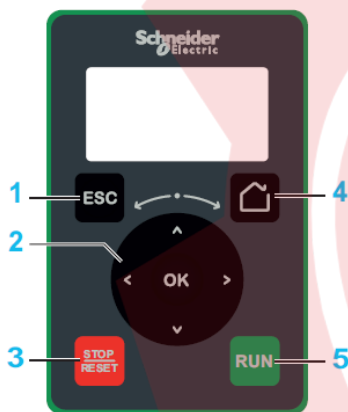

1. **ESC:** used to quit a menu/parameter, to clear the display of the triggered error or remove the currently displayed value in order to revert to the previous value retained in the memory
2. **Touch wheel / OK:** used to save the current value or access the selected menu/parameter. The touch wheel is used to scroll fast into the menus. Up/down arrows are used for precise selections, right/left arrows are used to select digits when setting a numerical value of a parameter.
3. **STOP / RESET:** stop command / apply a Fault Reset (a).
4. **Home:** used to access the home page.
5. **RUN:** executes the function (a).

(a) The **RUN** and **RESET** functions are active only if, in the menu **[Complete settings]** → **[Command channel]** :

- **[Control Mode]** is set to **[Standard Profile]**
- **[Command Switching]** is set to the channel commanding the display terminal

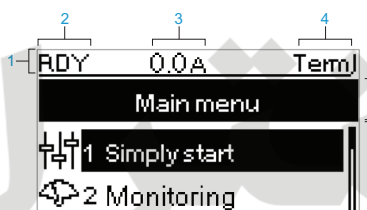

Key	
1	Display line
2	Soft starter state, refer to <i>Soft Starter State</i> , page 259
3	Monitored parameter user defined. Can be configured in <b>[My preferences]</b> .
4	Active control channel <ul style="list-style-type: none"> <li>• TERM: terminals</li> <li>• HMI: plain text display terminal</li> <li>• MDB: embedded Modbus serial</li> <li>• PWS: DTM based commissioning software</li> </ul>
5	<b>Menu line: indicates the name of the current menu or submenu.</b>
6	Menus, submenus, parameters, values, bar charts, and so on, are displayed in drop-down window format on a maximum of 2 lines. The line or value selected by the navigation button is displayed in reverse video.

# Graphic Display Terminal VW3A1111

The Graphic Display Terminal is available as an optional Display Terminal and can be plugged like the Plain Text Display Terminal, using the Modbus serial link connection, consequently the Embedded Display Terminal is deactivated. This Display Terminal can also be mounted on the door of the wall-mounted or floor-standing enclosure, refer to *Installing Door Mounting Kit*, page 69.

**NOTE:** When error **[HMI Com Interruption]** SLF3 is triggered, the active HMI becomes automatically the Embedded Display Terminal.

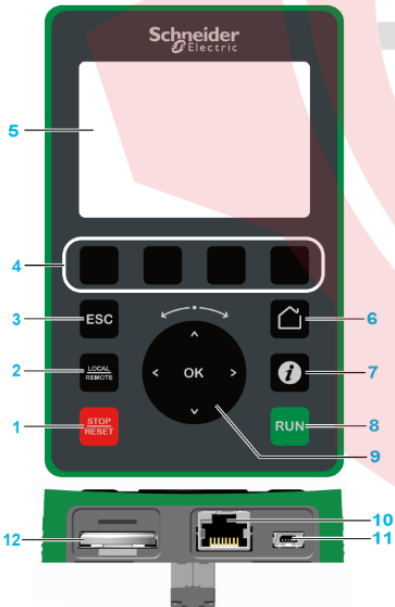

1. **STOP / RESET:** stop command / apply a Fault Reset (a).
2. **LOCAL / REMOTE:** used to switch between local and remote control of the soft starter.
3. **ESC:** used to quit a menu/parameter, to clear the display of the triggered error or remove the currently displayed value in order to revert to the previous value retained in the memory
4. **F1 to F4:** function keys used to access soft starter id, QR code, quick view, and submenus. Simultaneous press of F1 and F4 keys generates a screenshot file in the Graphic Display Terminal internal memory.
5. **Graphic display.**
6. **Home:** used to access the home page.
7. **Information:** used to have more information about menus, submenus, and parameters. The selected parameter or menu code is displayed on the first line of the information page.
8. **RUN:** executes the function (a).
9. **Touch wheel / OK:** used to save the current value or access the selected menu/parameter. The touch wheel is used to scroll fast into the menus. Up/down arrows are used for precise selections, right/left arrows are used to select digits when setting a numerical value of a parameter.
10. **RJ45 Modbus serial port:** used to connect the Graphic Display Terminal to the soft starter in remote control.
11. **MiniB USB port:** used to connect the Graphic Display Terminal to a computer.
12. **Battery:** The battery have no use for the soft starter and there is no alarm for display terminal low battery level.

(a) The **RUN** and **RESET** functions are active only if, in the menu **[Complete settings] → [Command channel]** :

- **[Control Mode]** is set to **[Standard Profile]**
- **[Command Switching]** is set to the channel commanding the display terminal

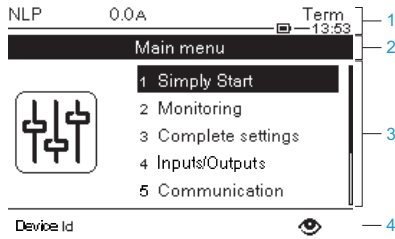

Key	
1	<b>Display line.</b>
2	<b>Menu line: indicates the name of the current menu or submenu</b>
3	Menus, submenus, parameters, values, bar charts, and so on, are displayed in drop-down window format on a maximum of five lines. The line or value selected by the navigation button is displayed in reverse video
4	Section displaying tabs (1 to 4 by menu), these tabs can be accessed using F1 to F4 keys



Key	
1	Soft starter state, refer to Soft Starter State, page 259.
2	Monitored parameter user defined, can be modified in <b>[My preferences]</b> .
3	Monitored parameter user defined, can be modified in <b>[My preferences]</b> .
4	Active control channel: <ul style="list-style-type: none"> <li>• TERM: terminals</li> <li>• HMI: Graphic display terminal</li> <li>• MDB: integrated Modbus serial</li> <li>• PWS: DTM based commissioning software</li> </ul>
5	Present time. Refer to Set date and time, page 91.
6	Battery level. Level of battery embedded in the soft starter. Refer to Replace the battery sub-chapter, page 248 for more information.

ماکان کنترول

# Configure the display terminal

## What's in This Chapter

Select languages.....	90
Set date and time .....	91
Select monitored parameter on Display line (Graphic Display Terminal only).....	92
Configure the screen contrast.....	92
Configure the backlight OFF time .....	92
Customize time to lock Display terminal keys.....	92
Activate/deactivate Parameter "STOP/RESET" Display terminal button .....	93
Set <b>HMI local/remote command</b> (Graphic Display Terminal only) .....	93
Configure the Display Terminal red backlight function (Graphic Display Terminal only) .....	94
Customize the default screen parameter visualization (Graphic Display Terminal only) .....	95
Select monitored parameter on Display line (Graphic Display Terminal only).....	96
List of parameters available for Default screen and display line (Graphic Display Terminal only).....	97
Customizable QR codes .....	97
Multipoint Screen .....	98

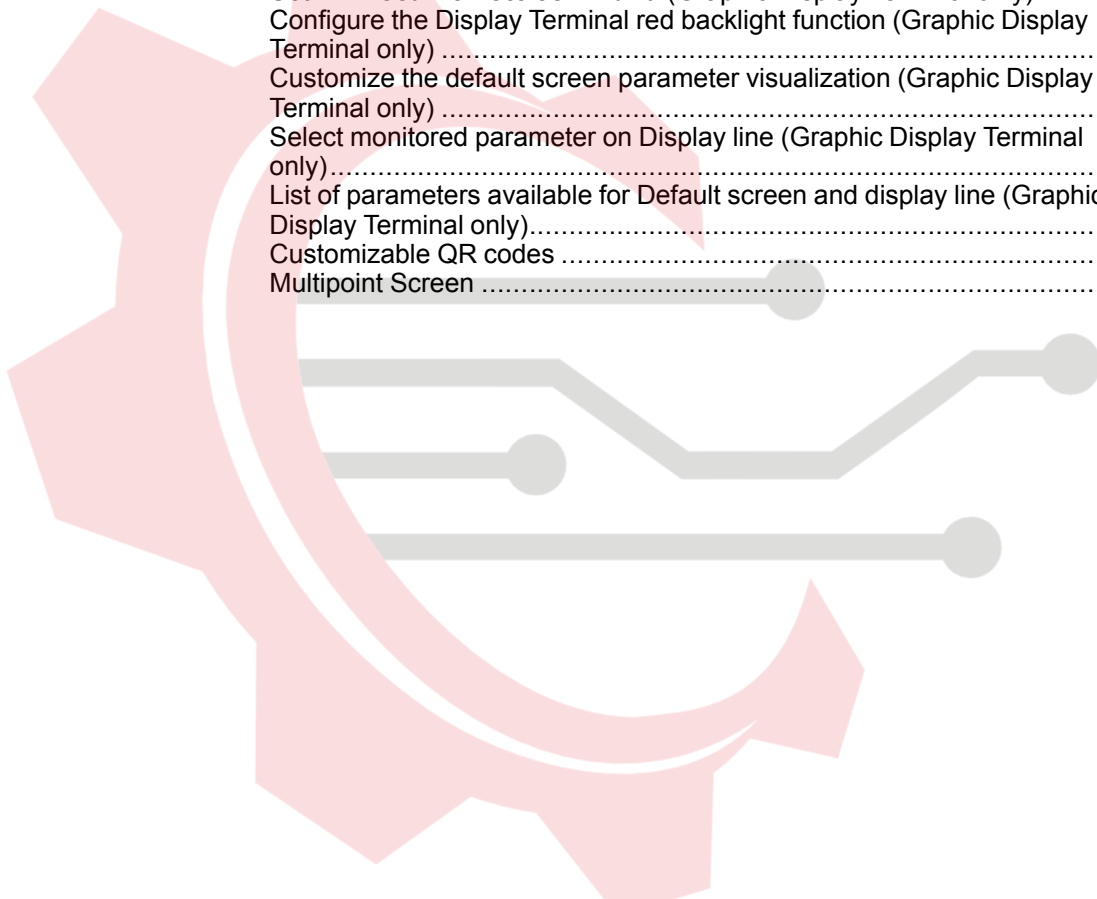

ماکان کنترول

## Select languages

The device contains some languages than can be selected through **[Language]** in **[My preferences]** menu.

- English (default)
- Chinese
- French
- German
- Italian
- Korean
- Russian
- Spanish
- Traditional Chinese
- Turkish

When using the graphical terminal display, there are 2 additional available languages: Polish and Brazilian.

It is possible to upload additional languages.

Plain text display terminal	Graphic display Terminal	
The soft starter shall be upgraded (firmware update) with specific firmware which has to be prepared with adequate languages.	1.	Download the latest version of language files here: <a href="#">Languages_Drives_VW3A1111</a>
	2.	Save the downloaded file on your computer.
	3.	Unzip the file and follow the instructions of the ReadMe text file.

ماکان کنترول

## Set date and time

This menu provides the parameters to set date and time. This information is used for the time stamping of all logged data.

Access path: **[Device Management] → [Date & Time]**

HMI label	Setting	Factory setting
<b>[Set Date/Time]</b> <small>DTO</small>	–	–
<p>Date and time information should be available (time server available and configured and the internal battery, page 248 is functional) at soft starter power up to enable the time stamping of the logged data.</p> <p>Setting <b>[Set Date/Time]</b> gives access to the parameter <b>[Time Zone]</b>, which can be used to set the offset between reference time and local time (by 15mn step).</p> <p><b>NOTE:</b> The time is displayed in the top right-hand corner of the display terminal.</p>		
<b>[Time Format]</b> <small>TIMF</small>	–	<b>[24h]</b>
<p>This parameter can be used to choose a time format to display on log file:</p> <ul style="list-style-type: none"> <li><b>[24h]</b>: Hour is displayed in a 24h format.</li> <li><b>[12h]</b>: Hour is displayed in a 12h format.</li> </ul>		
<b>[Date Format]</b> <small>DATE</small>	–	<b>[yyyy/mm/dd]</b>
<p>This parameter can be used to choose a date format to display on log file:</p> <ul style="list-style-type: none"> <li><b>[yyyy/mm/dd]</b>: Date is displayed as yyyy/mm/dd.</li> <li><b>[dd/mm/yyyy]</b>: Date is displayed as dd/mm/yyyy.</li> <li><b>[mm/dd/yyyy]</b>: Date is displayed as mm/dd/yyyy.</li> <li><b>[dd/mm/yy]</b>: Date is displayed as dd/mm/yy.</li> <li><b>[dd/mm]</b>: Date is displayed as dd/mm.</li> </ul>		

ماكان كنترول

## Select monitored parameter on Display line (Graphic Display Terminal only)

By default, the device displays the **Motor current**:

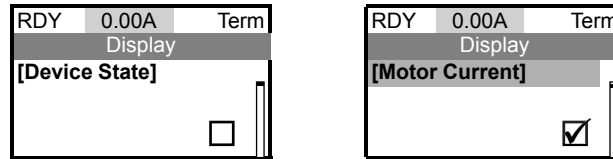

If using the graphic display terminal, 2 monitored parameters can be selected:

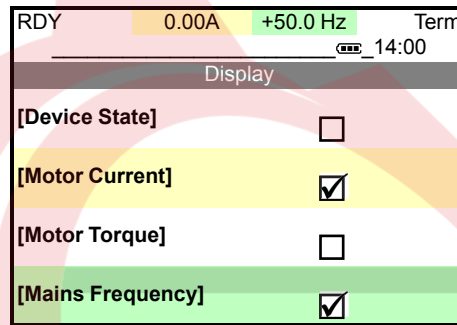

1. Go to **[Customization]**.
2. Select the parameter **[Param. Bar Select]** and check the monitored parameter to be displayed.

## Configure the screen contrast

Under the **[LCD settings]** menu, use the **[Screen Contrast]** parameter to configure the screen contrast.

## Configure the backlight OFF time

Under the **[LCD settings]** menu, use the **[Standby]** parameter to configure the automatic backlight OFF time.

**NOTE:** Disabling the automatic standby function of the display terminal backlight will reduce the backlight service life.

## Customize time to lock Display terminal keys

Under the **[LCD settings]** menu, use the **[Display Terminal locked]** parameter to configure the Display Terminal key locked.

The parameter **[Display Terminal locked]** can be set to **NO** or to 1...10 min.

**NOTE:** Press **ESC** and **OK** keys (or **ESC** and **Home** keys in case of a graphic display terminal) to lock or unlock manually the embedded display terminal keys. The **STOP** key remains active when the Display Terminal is locked.

**NOTE:** If cybersecurity auto logout is enable, **[Display Terminal locked]** is no more use. Please refer to Auto logout, page 178 for more information.

## Activate/deactivate Parameter “STOP/RESET” Display terminal button

Under the [Customization] menu, use the parameter [Stop Key Enable] to set the priority for the STOP / RESET button on the display terminal.

- [Stop Key Priority] : Enable the STOP / RESET button. It is possible to press STOP / RESET key when active command channel is not the display terminal to stop the motor.
- [Stop Key No Priority] : Disable the STOP / RESET button if it is not the active channel set in [Command channel]

Setting this function to [Stop Key No Priority] NO disables the Stop key of the Display Terminals if the active command channel is not [HMI] LCC.

<b>⚠ WARNING</b>
<b>LOSS OF CONTROL</b>
Only set this parameter to [Stop Key No Priority] NO if you have implemented appropriate alternative stop functions.
<b>Failure to follow these instructions can result in death, serious injury, or equipment damage.</b>

## Set HMI local/remote command (Graphic Display Terminal only)

**Graphic Display Terminal only.**

**From remote to local**

Under the [Customization] menu, use the parameter [HMI L/R cmd] to set the HMI local/remote command:

- [Stop On Switching]: Apply a Stop order according to [Type of stop] when switching from Remote to Local.
- [Bumpless] : Apply no stop order when switching from Remote to Local.
- [Disabled] : Disable the Local / Remote display terminal key (factory setting).

**From local to remote:**

The operating state of the device after a transition from local command to remote command depends on the configuration of the device.

<b>⚠ WARNING</b>
<b>UNANTICIPATED EQUIPMENT OPERATION</b>
Verify that the transition from local command to remote command does not result in unsafe conditions.
<b>Failure to follow these instructions can result in death, serious injury, or equipment damage.</b>

## Configure the Display Terminal red backlight function (Graphic Display Terminal only)

**Graphic Display Terminal only.**

Under the **[LCD settings]** menu, use the **[Red Backlight]** parameter to configure the Display Terminal red backlight function in case of an error triggered.

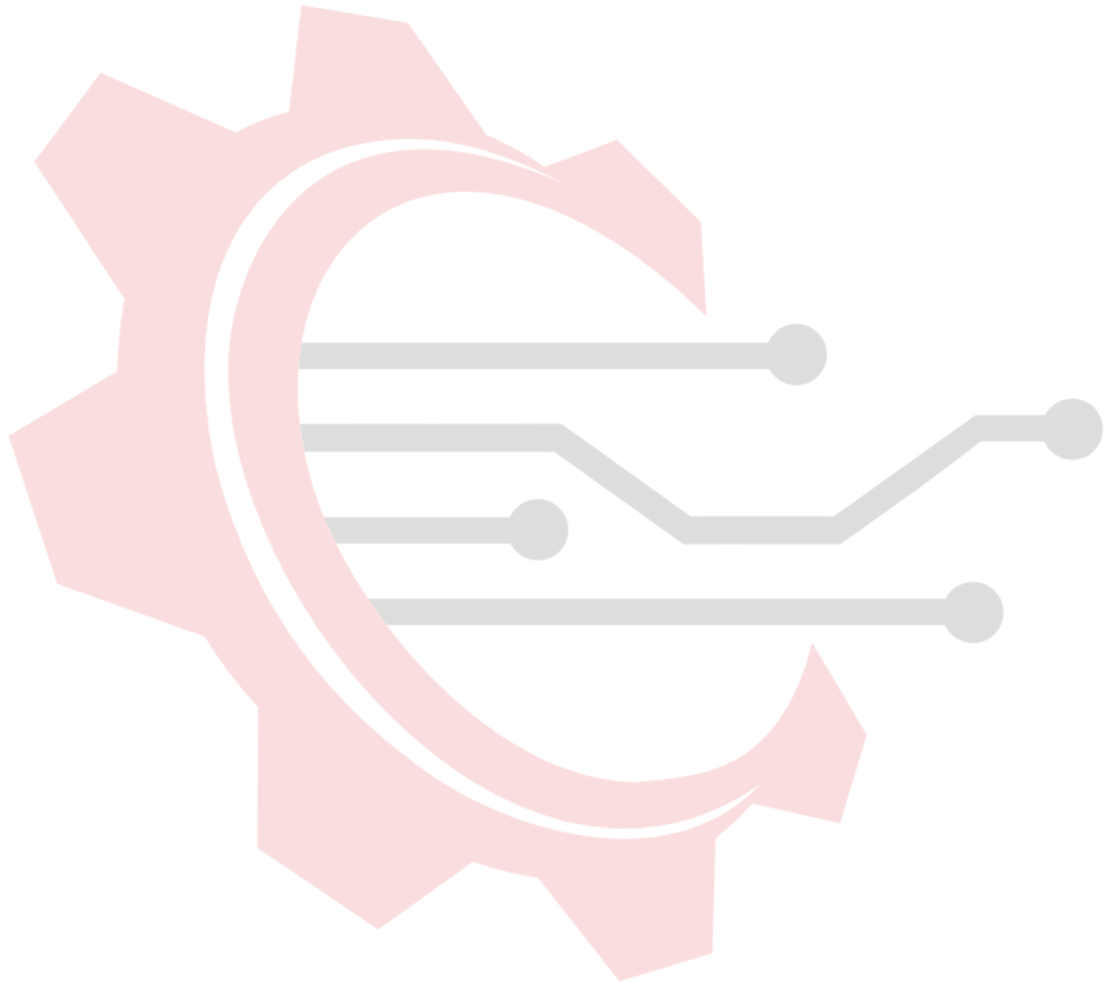

ماکان کنترول

# Customize the default screen parameter visualization (Graphic Display Terminal only)

## Graphic Display Terminal only.

Under the [Customization] menu → [Display screen type] menu, use the parameter [Display value type] to select the *HMI displayed value type*.

- [Digital] values, up to 2 parameters can be selected (factory setting):

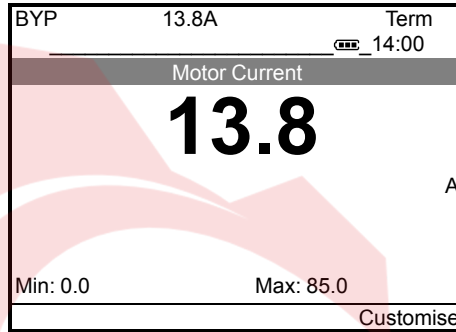

- [Bar graph], up to 2 parameters can be selected and not all listed parameters are selectable:

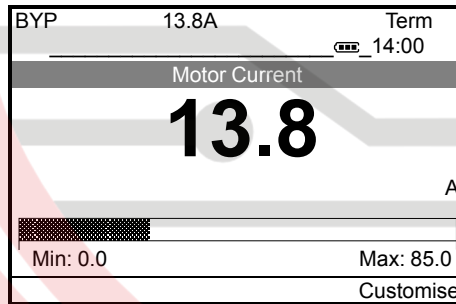

- [List] of values, up to 5 parameters can be selected:

## Graphic Display Terminal only.

By default, the device displays the *Nominal current* on the default screen.

Under the [Customization] menu → [Display screen type] menu.

Select the tab [Parameter Selection] to select the parameters to display on the default screen.

**NOTE:** The maximum number of selected parameters is 5.

[Display screen type] menu:

RDY			13.8A	+50.0 Hz	Term
					14:00
Display					
[Device State]		<input type="checkbox"/>			
[Motor Current]		<input checked="" type="checkbox"/>			
[Current RMS T1]		<input type="checkbox"/>			
Type	Param				

Home page:

RDY			13.8A	+50.0 Hz	Term
					14:00
Display					
[Motor Current]	13.8A				
[Mains Frequency]	50.0Hz				
Locate	Customise				

**[Vu Meter]** (1 parameter can be selected and not all listed parameters are selectable):

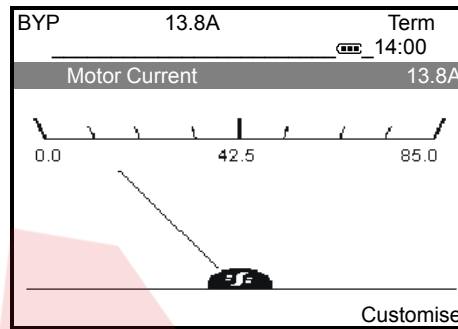

## Select monitored parameter on Display line (Graphic Display Terminal only)

By default, the device displays the **Motor current**:

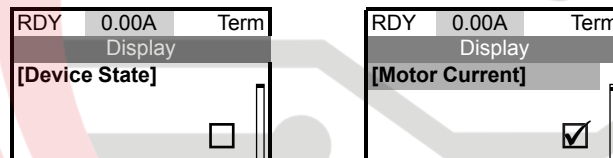

If using the graphic display terminal, 2 monitored parameters can be selected:

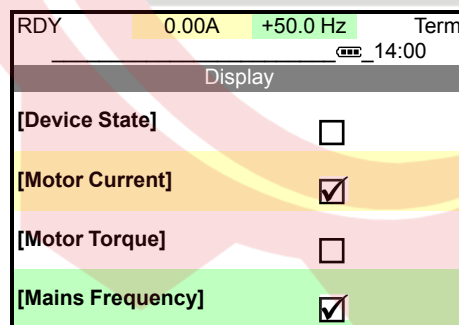

1. Go to **[Customization]**.
2. Select the parameter **[Param. Bar Select]** and check the monitored parameter to be displayed.

## List of parameters available for Default screen and display line (Graphic Display Terminal only)

The list is partially applicable for [List], [Vu Meter], [Bar graph], [Digital] and Display line.

- 1. [Device State]: *HMI status*
- 2. [Motor Current]: *Motor current*
- 3. [Current RMS T1]: *Current RMS Phase T1*
- 4. [Current RMS T2]: *Current RMS Phase T2*
- 5. [Current RMS T3]: *Current RMS Phase T3*
- 6. [Motor Torque]: *Motor torque*
- 7. [Mains Frequency]: *Mains frequency*
- 8. [Peak Elec Out Power]: *Peak electrical output power*
- 9. [Power Factor]: *Power factor*
- 10. [Motor Run Time]: *Motor run time*
- 11. [Power-on time]: *Power-on time*
- 12. [Nb Of Starts]: *Number of motor starts*
- 13. [AQ1]: *AQ1 physical value*
- 14. [Motor therm state]: *Motor thermal state*
- 15. [Device Thermal State]: *Device thermal state*
- 16. [Elc Energy Cons]: *Electrical energy consumed by the motor (KWh)*
- 17. [Elc Energy Cons]: *Electrical energy consumed by the motor (MWh)*
- 18. [Elc Energy Cons]: *Electrical energy consumed by the motor (GWh)*
- 19. [Elc Energy Cons]: *Electrical energy consumed by the motor (TWh)*
- 20. [Elc Egy Today]: *Electrical energy consumed TODAY by the motor (KWh)*
- 21. [Elc Egy Yesterday]: *Electrical energy consumed YESTERDAY by the motor (KWh)*

## Customizable QR codes

Access path : [My preferences] → [QR code]

This menu gives access to 5 QR Codes:

- [QR code] [QRC](#) : scanning this QR code brings to a landing page on Internet with the information on the Technical product datasheet and a link for Schneider Electric App available for services.
- [My Link 1] [MYL1](#) to [My Link 4] [MYL4](#) : 4 QR codes customizable with the commissioning software. By default, scanning these QR codes brings to the same landing page as [QR code] [QRC](#). To customize these QR codes with SoMove, go to "Device > HMI Personalization > QR codes".

**NOTE:** The name "My link x" can also be changed during the customizing.

# Multipoint Screen

## Overview

Generally, a Graphic Display Terminal is connected to only one soft starter. However, communication is possible between a Graphic Display Terminal and several Altivar soft starters and Altivar drives, and connected on the same Modbus serial fieldbus via the RJ45 port (HMI or Modbus serial). In such a case, the multipoint mode is automatically applied on the Graphic Display Terminal.

The multipoint mode allows to:

- Have an overview of all the soft starters connected on the fieldbus (soft starter state and two selected parameters).
- Access to all the menus of each soft starter connected on the fieldbus.
- Command a stop on all the connected soft starters with the **STOP/RESET** key (irrespective of the present screen displayed). The type of stop can be individually configured on each soft starter with the parameter **[Stop Key Enable]** in the menu **[My preferences]**.

Except /Apart from the Stop function linked to the **STOP/RESET** key, the multipoint mode does not allow to apply a Fault Reset and command the soft starter via the Graphic Display Terminal: in multipoint mode, the Run key and the Local/Remote key are deactivated.

## Prerequisites

To use the multipoint mode:

- The Graphic Display Terminal software version must be equal to or higher than V2.3.
- For each soft starter, the command channel must be set in advance to a value different from **[HMI]**.
- The address of each soft starter must be configured in advance to different values by setting the parameter **[Modbus Address]** in the **[Modbus Fieldbus]**.

## Example of Installation Topology

The following figure gives a topology example using four soft starters, a Modbus "T" tap-off (VW3A8306TF03) and one Graphic Display Terminal (VW3A1111) linked to one Modbus splitter block (LU9GC3):

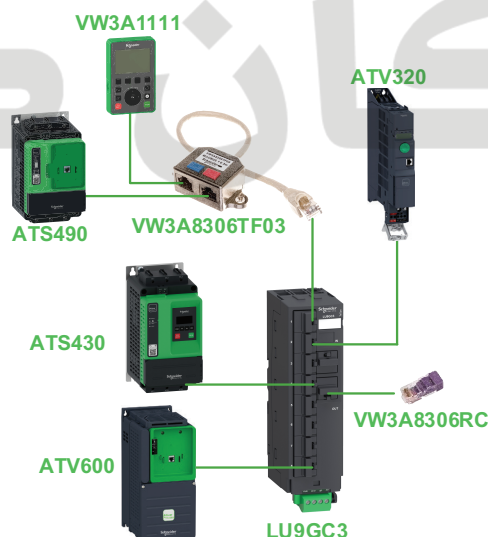

## Screens for Multipoint Mode

The following figure gives the browsing between the different screens linked to the multipoint mode:

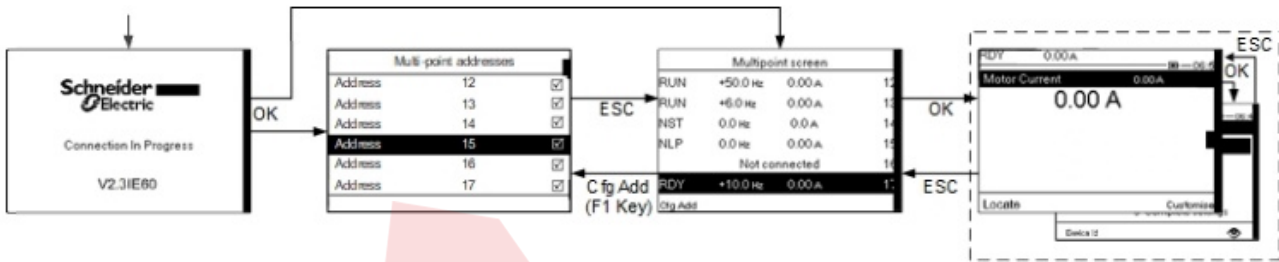

On the fieldbus common with the Graphic Display Terminal, if two or more soft starters are powered on, you access to the **[Connection in progress]** screen. If there is no address selected by the Graphic Display Terminal or no recognized address, the Graphic Display Terminal is locked on this screen. Press OK key to access to the **[Multi-point Addresses]** screen. Otherwise, if there are addresses-selected and one of them have been recognized by the Graphic Display Terminal, the screen switches automatically to **[Multipoint screen]**.

The **[Multi-point Addresses]** screen allows to select, by pressing OK key, the addresses of the soft starters you want to connect with. Up to 32 addresses can be selected (address setting range: 1...247). When all the addresses have been selected, press ESC key to access to the **[Multipoint screen]**.

**NOTE:** To help prevent a low refresh rate of the Graphic Display Terminal screen, do not select addresses that are not corresponding to soft starter addresses.

On the **[Multipoint screen]**, the touch wheel is used to navigate between the soft starter overviews. Access to the menus of the selected soft starter by pressing OK key. Return to the **[Multipoint screen]** by pressing ESC key.

**NOTE:** To access the **[Multi-point Addresses]** screen from the **[Multipoint screen]**, press F1 key.

If a soft starter triggers an error, the Graphic Display Terminal goes automatically to the **[Multipoint screen]** on the overview of the latest soft starter who has triggered an error.

The two parameters given in the soft starter overview can be modified individually on each soft starter in **[Param. Bar Select]**.

ماکان کنترول

# Commissioning

## What's in This Part

First Power-Up .....	101
Define Parameter visibility .....	106
Define Favorite Parameters List .....	109
Main Menu Presentation .....	110
Simply Start .....	111
Monitoring Settings .....	117
Other Settings .....	134
Small Motor Test .....	138
Torque / Voltage Control .....	140
Start and Stop .....	142
Motor Preheating .....	143
Smoke Extraction .....	148
Voltage Boost .....	150
Functions Compatibility Table .....	151
Command Channel .....	152
Input/Output Assignment .....	156

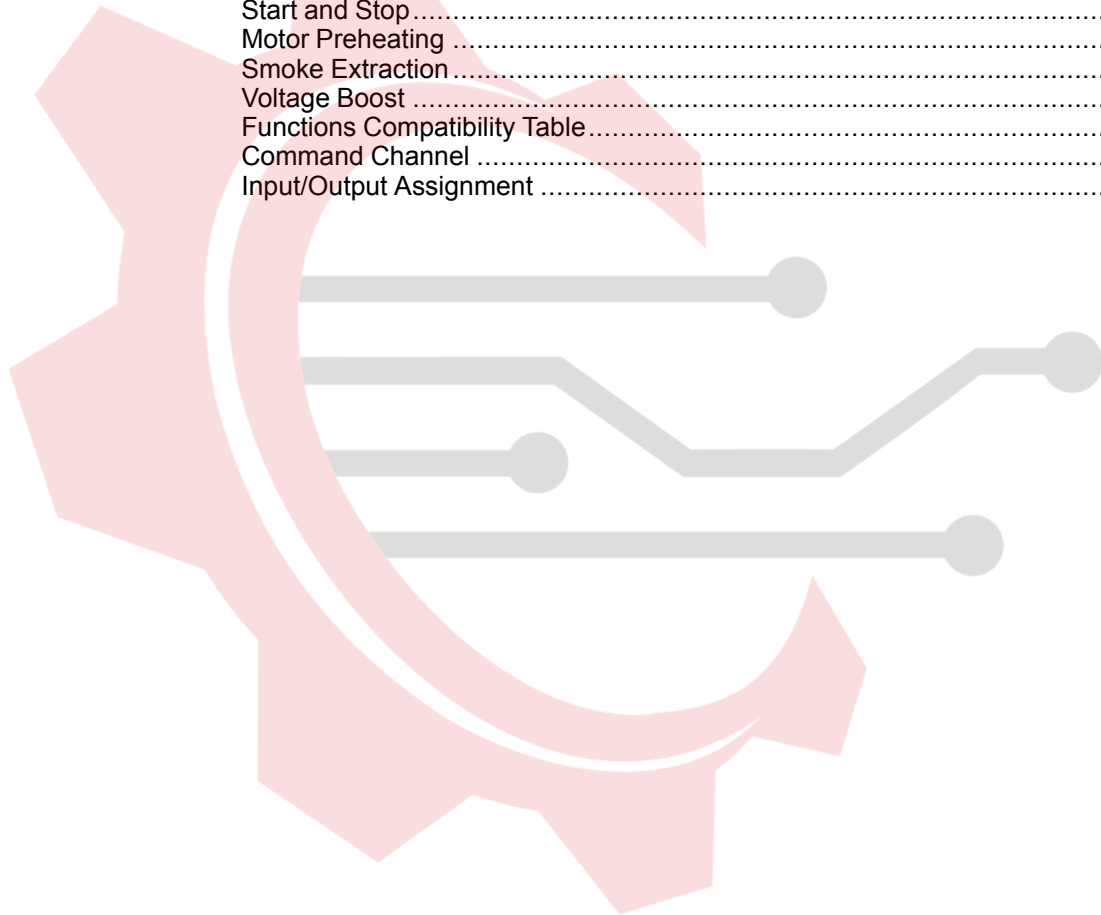

ماکان کنترول

## First Power-Up

When powering-Up the ATS430 for the first time by applying 110.230 Vac on A1 and A2 terminals, before operating it is mandatory to :

### Set the language

Select the language. It can be changed after this setup, for more details see [Select languages, page 90](#).

### Set the Time Zone and Set the Date and Time.

Check the set time zone, date and time.

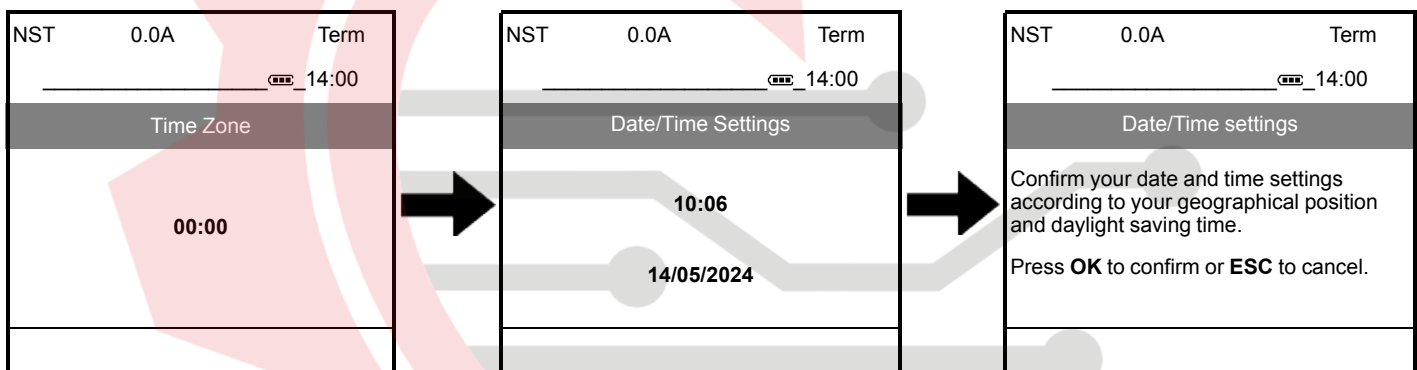

Long press **OK** to confirm or **ESC** to cancel and return to the **[Time Zone]** screen.

Time Zone and Date and Time can be changed after this setup, for more details see [Date and Time settings, page 91](#).

ماکان کنترول

## Go to product by setting cybersecurity policy (advanced, minimum)

To go into operational mode you need to configure the cybersecurity

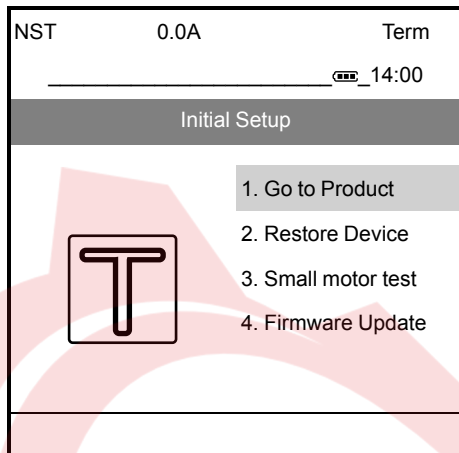

At the first power up, the soft starter ATS430 proposes minimum step-by-step settings in order to select the cybersecurity policy.

Step	Action
1	<p>1. In the <b>[Initial Setup]</b> menu, scroll to <b>[Go to product]</b> and press <b>OK</b>.</p> <p>2. Choose a cybersecurity policy:</p> <ul style="list-style-type: none"> <li>• To set <b>no credentials</b> to access this device, refer to step 2 – a.</li> <li>• To set <b>credentials</b>, refer to step 2 – b.</li> <li>• To <b>load an existing cybersecurity policy</b> already set and exported from a compatible device, refer to step 2 – c.</li> </ul> <p>For more information about the cybersecurity policies, refer to <i>ATS430 Security Policy</i>, page 54.</p>
2 – a	<p>1. Scroll to <b>[Minimum Cybersec]</b> and press <b>OK</b>.</p> <p>2. Read the message explaining the functionalities of this profile and press <b>OK</b> to validate and access the <b>[Access Level]</b> parameter or <b>ESC</b> to cancel the selection.</p> <p>3. Refer to <i>Define Parameter visibility</i>, page 106 to set your access level and access the main menu of the device.</p> <p><b>Result:</b> The device is ready to be commissioned.</p> <p>Disabling this feature, no credentials will be required to access your process or machine. This setting is saved with the configuration and will be active if a configuration is loaded or copied.</p> <div style="border: 1px solid black; padding: 5px; margin-top: 10px;"> <p style="text-align: center; font-weight: bold; font-size: 1.2em;">⚠ WARNING</p> <p style="text-align: center; font-weight: bold; font-size: 1.1em;">UNAUTHENTICATED ACCESS AND MACHINE OPERATION</p> <p>Do not disable the feature if your machine or process is accessible to unauthorized personnel either directly or via a network.</p> <p><b>Failure to follow these instructions can result in death, serious injury, or equipment damage.</b></p> </div> <p>For more information about the cybersecurity policies, refer to <i>ATS430 Security Policy</i>, page 54.</p>

Step	Action
2 – b	<ol style="list-style-type: none"> <li>1. Scroll to <b>[Advanced Cybersec]</b> and press <b>OK</b>.</li> <li>2. Set a password and press <b>OK</b> to confirm it or <b>ESC</b> to cancel the selection.</li> <li>3. Verify the set credentials and press <b>OK</b> to confirm them or <b>ESC</b> to cancel the selection.</li> <li>4. Scroll down to display the confirmation message, press <b>OK</b> to validate this cybersecurity policy and access the <b>[Access Level]</b> parameter or press <b>ESC</b> to cancel the selection.</li> <li>5. Refer to Define Parameter visibility, page 106 to set your access level and access the main menu of the device.</li> </ol> <p><b>Result:</b> The device is ready to be commissioned.</p> <p>For more information about the cybersecurity policies, refer to <i>ATS430 Security Policy</i>, page 54.</p>
2 – c	<ol style="list-style-type: none"> <li>1. Scroll to <b>[Load security policy]</b> and press <b>OK</b>.</li> <li>2. Scroll to the cybersecurity policy file (.secp) to upload on the device and press <b>OK</b> to transfer the file and access the <b>[Access Level]</b> parameter or <b>ESC</b> to cancel your selection.</li> </ol> <p>Refer to <i>Soft Starter Configuration files</i>, page 165 for more information on soft starter configuration files.</p> <ol style="list-style-type: none"> <li>3. Refer to Define Parameter visibility, page 106 to set your access level and access the main menu of the device.</li> </ol> <p>For more information about the import / export of cybersecurity policies, refer to <b>Import / Export Security Policy</b> in <i>ATS430 Security Policy</i>, page 54.</p> <p><b>Result:</b> The cybersecurity policy is set and the device is ready to be commissioned.</p>

**NOTE:** Once the steps are done (the cybersecurity policy is selected), the pre-operating procedure will not be required at the next power up and the device is ready for operation.

**NOTE:** The complete configuration of cybersecurity is accessible through *ATS430: DTM*.

## Restore a device configuration (Situational)

In case of a product replacement or a similar situation, it is possible to restore a configuration. Refer to *Save & Restore a device image*, page 167 for more information.



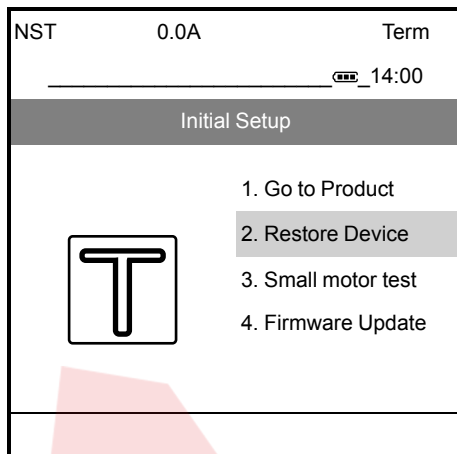

Step	Action
1	In the <b>[Initial Setup]</b> menu, scroll to <b>[Restore device]</b> and press <b>OK</b> .
2	Select <b>[Load backup image]</b> , press <b>OK</b> and select a .bki file. Refer to Soft Starter Configuration files, page 165 for more information on soft starter configuration files.
3	Read carefully the message on the display terminal and press <b>OK</b> to validate. <b>Result:</b> The device is ready to be commissioned. The previous device cybersecurity policy will be erased by this new configuration. For more information about the cybersecurity policies, refer to ATS430 Security Policy, page 54.

## Perform a small motor test (Situational)

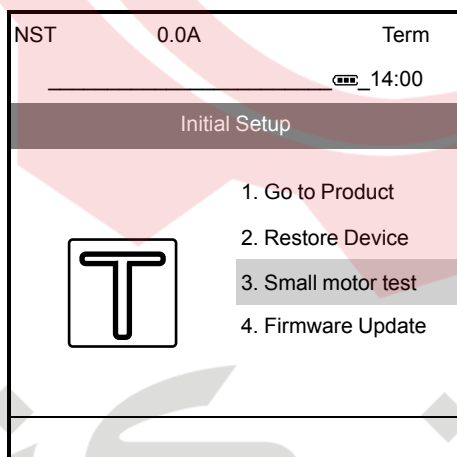

It is possible that in some cases, the user may not want or is not allowed to configure the cybersecurity or restore a device configuration.

For instance, when testing the soft starter mains supply wiring with **[Small Motor Test]**. For more details, refer to Small Motor Test, page 138.

## Check if the device is up to date (Situational)

It is possible to have a firmware package to be applied on the device.

Verify if there is a firmware update to apply by selecting **[Firmware update]** then Check for Update:

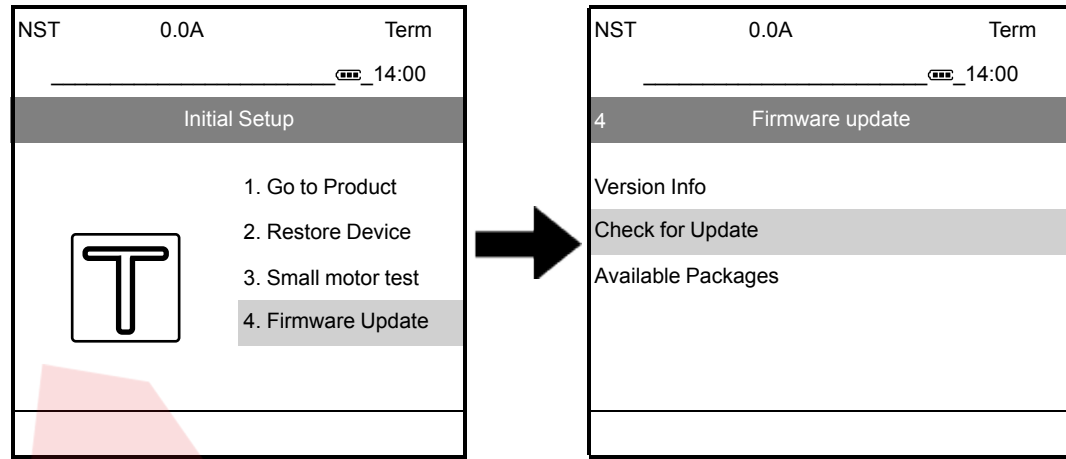

If the Product is up to date, two possibilities can appear:

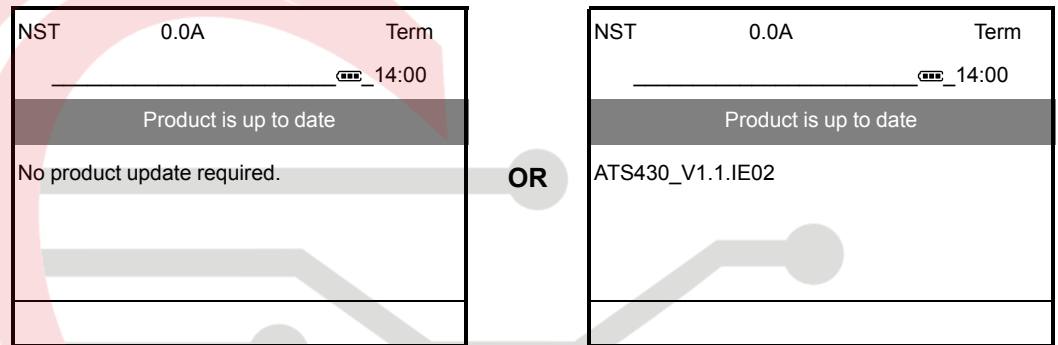

If firmware package is available, please follow this process:

Step	Action
1	Select the firmware package.
2	Apply the new firmware.
3	Pass through the <b>Release Info</b> step by pressing the <b>OK</b> button.
4	Pass through the <b>FW UPDATE</b> step by pressing the <b>OK</b> button.
5	These messages appear: <ol style="list-style-type: none"> <li>1. You are about to apply a new firmware.</li> <li>2. Please wait for completion.</li> <li>3. Product update is in progress.</li> <li>4. Product restart in progress.</li> </ol>
6	The final message "Firmware update has been correctly applied" appears. Press <b>OK</b> to continue the first power up procedure.

**NOTE:** To do a Firmware Update after your first power procedure, refer to Soft starter firmware update, page 171

## Define Parameter visibility

The device allows to hide/show defined directory or parameter of the Display terminal navigation menu. This could simplify the navigation by reducing number of directory or could reduce the risk of parameter modification by any users. Hiding a directory or a parameter does not deactivated the related function.

The device has 3 macro visibility level defined by the parameter **[Access Level]**. By default, the **[Access Level]** is set to **[Standard]**.

To change, go to **[My preferences]** → **[Parameter access]** menu, use and change **[Access Level]** according to :

<b>[Menu]</b>	All parameters	✓	All the parameters of this menu are visible for this access level.
<b>[Menu]</b>		✓	All the parameters of this menu are visible for this access level, except <b>[Parameter]</b>
	<b>[Parameter]</b>	-	
<b>[Menu]</b>		-	This menu and the parameters of this menu are not visible in this access level

**NOTE:** Not all sub-menus and parameters are represented in the following table. Refer to HMI Tree Navigation, page 260 for the complete listing of menus, sub-menus and parameters.

Menus	Sub-menus/Parameters	[Access Level]		
		[Standard]	[Basic]	[Expert] 
<b>[My menu]</b>		✓	✓	✓
<b>[Simply Start]</b>		✓	✓	✓
	All parameters	✓	✓	✓
<b>[Monitoring]</b>		✓	✓	✓
	<b>[Gamma Sync Enable]</b>	-	-	✓
<b>[Complete settings]</b>		✓	-	✓
	<b>[Torque Limit]</b>	-	-	✓
	<b>[Stator Loss Comp]</b>	-	-	✓
	<b>[Control Mode]</b>	-	-	✓
	<b>[Command Switching]</b>	-	-	✓
	<b>[Cmd channel 2]</b>	-	-	✓

Menus	Sub-menus/Parameters	[Access Level]		
		[Standard]	[Basic]	[Expert] 
	[Copy Ch1-Ch2]	-	-	✓
	[Disable Error Detect]	-	-	✓
[Input/Output]		✓	✓	✓
	[AQ1 Filter]	-	-	✓
	[R2 Delay time]	-	-	✓
	[R2 Active at]	-	-	✓
	[R2 Holding time]	-	-	✓
[Communication]		✓	-	✓
	[Term word order]	-	-	✓
	[Term 3 word order]	-	-	✓
[Display]		✓	✓	✓
	All parameters	✓	✓	✓
[Diagnostics]		✓	✓	✓
	[Product restart]	✓	-	✓
[Device Management]		✓	✓	✓
	[Copy From Device]	✓	-	✓
	[Copy To The Device]	✓	-	✓
	[Save security policy]	✓	-	✓
	[Load security policy]	✓	-	✓
	[Save backup image]	✓	-	✓
	[Load backup image]	✓	-	✓

Menus	Sub-menus/Parameters	[Access Level]		
		[Standard]	[Basic]	[Expert] 
	[Config. Source]	✓	-	✓
	[Parameter group list]	✓	-	✓
	[Go to Factory Settings]	✓	-	✓
	[Save Configuration]	✓	-	✓
	[Version Info]	-	-	✓
	[Check For Update]	-	-	✓
	[Available Packages]	-	-	✓
	[Clear device]	-	-	✓
[My preferences]		✓	✓	✓
	[Stop Key Enable]	✓	-	✓
	[HMI L/R cmd]	✓	-	✓
	[My menu config.]	✓	-	✓
	[Display screen type]	✓	-	✓
	[Param. Bar Select]	✓	-	✓
	[Service Message]	✓	-	✓

## Define Favorite Parameters List

The following parameters allow to customize **[My menu]** MYMN.

**[My menu]** allows the user to save his favorite parameters in a single menu.

Access path: **[My preferences]** → **[Customization]** → **[My menu config.]**

HMI label	Setting	Factory setting
<b>[Parameter Selection]</b> <small>UMP</small>	–	–
This menu shows the content of <b>[Complete settings]</b> menu and allows to: <ul style="list-style-type: none"> <li>Select the parameters visible in <b>[My menu]</b>.</li> <li>Remove the selected visible parameters from <b>[My menu]</b>.</li> </ul>		
<b>[Display Selection]</b> <small>MDP</small>	–	–
This menu shows the content of <b>[Display]</b> menu and allows to: <ul style="list-style-type: none"> <li>Select the parameters visible in <b>[My menu]</b>.</li> <li>Remove the selected visible parameters from <b>[My menu]</b>.</li> </ul>		
<b>[Selected list]</b> <small>UML</small>	–	–
This menu displays the parameters selected via <b>[Parameter Selection]</b> and <b>[Display Selection]</b> . With the Graphic Display Terminal, this menu allows to sort and remove the selected parameters using the function keys (F1, F2 and F3). <b>NOTE:</b> Up to 25 parameters can be selected to be displayed in the customized menu.		
<b>[My Menu]</b> <small>MYMN</small>	–	–
With the Graphic Display Terminal, this parameter allows to rename <b>[My menu]</b> .		

## Main Menu Presentation

☆ 0 [My menu]	A list of parameters chosen by the user.
⚙️ 1 [Simply Start]	Minimum parameters to start and stop a motor.
📊 2 [Monitoring]	Electrical and thermal monitoring functions.
🔧 3 [Complete settings]	Advanced settings for fine-tuning.
↶ 4 [Input/Output]	Inputs/Outputs configuration.
📡 5 [Communication]	Fieldbus communication configuration.
☂️ 6 [Display]	Monitoring of key values.
📄 7 [Diagnostics]	Soft starter history, current state and motor thermal state.
⚙️ 8 [Device Management]	Cybersecurity, time setting, firmware update and factory settings.
🗣️ 9 [My preferences]	Device and display terminal configuration.

ماكان كنترول

# Simply Start

## What's in This Chapter

Example Of Typical Configurations For Common Applications .....	112
Set The Current & Current Limitation .....	112
Set Start Profile .....	114
Set Stop Profile .....	115

The  **[Simple Start]** menu provides:

- The minimum parameters to start and stop a class 10E induction motor in torque control.
- The list of ten last parameters directly modified by the user via the display terminal in the **[Modified parameters]** sub-menu. It is possible to edit the modified parameters from this sub-menu.

For typical configuration examples refer to Example Of Typical Configurations For Common Applications, page 112.

In this chapter it is assumed that the soft starter uses the torque control law command to pilot a motor wired in-line with the mains supply.

For other configuration, refer to the **[Complete settings]** menu in the chapter "Start and stop".

ماکان کنترول

## Example Of Typical Configurations For Common Applications

Application	[Current Limit] <b>ILT</b> (% of [Motor Nom Current] <b>IN</b> )	[Acceleration] <b>ACC</b> (s)	[Init Starting Torque] <b>TQ0</b> (% of nominal torque)	[Type of stop] <b>STT</b>
Centrifugal pump	450	5 to 15	0	[Deceleration]
Submersible pump	450	Up to 2	0	[Deceleration]
Piston pump	525	5 to 10	30	[Deceleration]
Fan	450	10 to 40	0	[Freewheel]
Cold compressor	450	5 to 10	30	[Deceleration]
Screw compressor	450	3 to 20	30	[Deceleration]
Centrifugal compressor	450	10 to 40	0	[Freewheel]
Piston compressor	525	5 to 10	30	[Deceleration]
Conveyor, transporter	450	3 to 10	30	[Deceleration]
Agitator	525	5 to 20	10	[Deceleration]
Mixer	525	5 to 10	50	[Deceleration]

## Set The Current & Current Limitation

The following parameters can be used to have a smooth and progressive start a motor by limiting the current in the motor during the start and ramp-up. This reduces the current surge at the start, the mechanical stress on the motor and reduces potential overloading of the electrical distribution network.

The value set to **[Motor Nom Current]** determines the current of the motor thermal monitoring, depending on which motor class is set. For more information regarding the motor thermal monitoring and the selection of the motor class, refer to Motor Thermal Protection Class, page 118.

Step	Action
1	Set <b>[Motor Nom Current]</b> to the value of the nominal motor current indicated on the motor nameplate.
2	Set the current limitation with the <b>[Current Limit]</b> parameter.

With the maximum load, the current limitation should be set at a high enough value to allow the motor to start. If the application requires more than 500% the soft starter current rating, a higher rated soft starter must be selected.

Access path: **[Simply Start] → [Simply start]**

**OR [Complete settings] → [Motor parameters]**

HMI label	Setting	Factory setting
<b>[Motor Nom Current]</b> <i>IN</i>	(1)	(2)
<p><b>Nominal current</b></p> <p>Adjust the value of <b>[Motor Nom Current]</b> according to the rated motor current indicated on the motor nameplate.</p> <p>(1) <b>[Motor Nom Current]</b> value ranges between 0.4 and 1 of soft starter rating (<b>Ie</b>, rated operational current)</p> <p>The value set to <b>[Motor Nom Current]</b> determines the current of the motor thermal monitoring, depending on which motor class is set. For more information regarding the motor thermal monitoring and the selection of the motor class, refer to <i>Motor Thermal Protection Class</i>, page 118.</p> <p>(2) Factory setting of <b>[Motor Nom Current]</b> corresponds to the usual value of a 4-pole 400 V standardized induction motor.</p> <p>The unit of the product display depends on the product size.</p> <ul style="list-style-type: none"> <li>For sizes smaller than ATS430C25S6, the unit is 0.1 A.</li> <li>For ATS430C25S6 and up, the unit is 1 A.</li> </ul>		

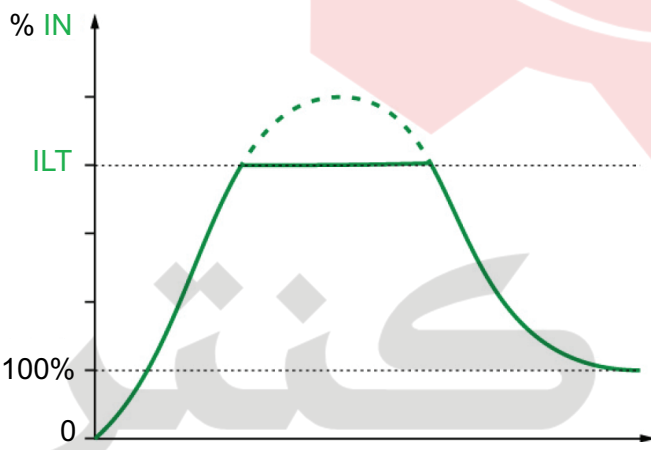
HMI label	Setting	Factory setting
<b>[Current Limit]</b> <i>ILT</i>	150...700%	400% of <b>[Motor Nom Current]</b> <i>IN</i>
<p><b>Motor limiting current</b></p> <p>The RMS motor line current will be limited to <b>[Current Limit]</b> multiplied by <b>[Motor Nom Current]</b>.</p> <p><b>[Current Limit]</b> max setting is limited to <math>500\% \times I_e / I_N</math></p> <p>The <b>[Current Limit]</b> max setting will not exceed 700% of nominal motor line current.</p> <p>The current limit setting is always active during start up and overrides all other settings.</p>  <p><b>Example:</b>  ATS430C21S6, with <b>Ie</b> = 210 A  <b>[Motor Nom Current]</b> = 195 A  <b>[Current Limit]</b> = 500% (under max setting : <math>500\% \times I_e / I_N = 5 \times 210 / 195 = 538\%</math>)  Current limitation = <math>500\% \times 195 = 975</math> A</p>		

## Set Start Profile

The following parameters can be used to control the start of the motor by defining the ramp-up time and the initial torque applied.

**[Acceleration]** control the ramp-up time from the Run order to established regime.

**[Init Starting Torque]** set the initial starting torque.

Step	Action
1	Adjust the ramp time of the soft starter torque between 0 and the nominal torque with <b>[Acceleration]</b> .
2	Set the initial torque during the starting phase with the <b>[Init Starting Torque]</b> parameter.

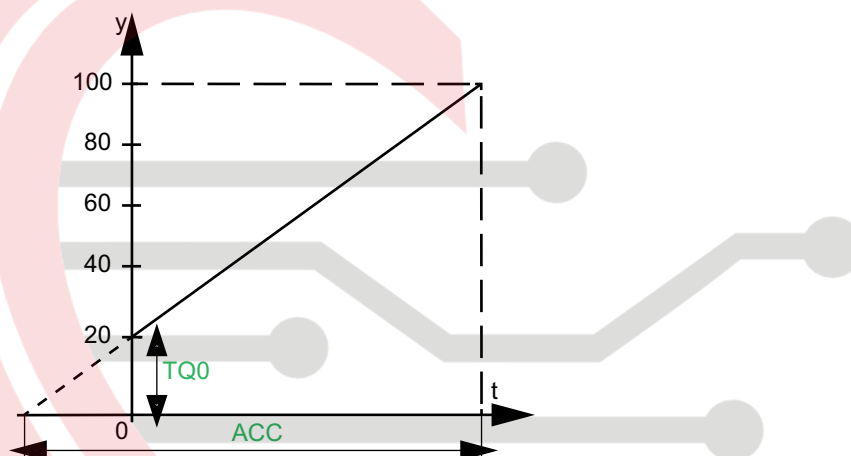

- y: Reference torque as % of nominal torque
- t: Time (s)
- **TQ0**: *Initial starting torque*
- **ACC**: *Acceleration ramp time*

By default, **[Control Mode]** is set to **[Torque Control]**, it is also possible to set in to **[Voltage Control]**. For more information, refer to Torque / Voltage Control, page 140.

Access path: **[Simply Start] → [Simply start]**

**OR [Complete settings] → [Start & Stop]**

Description	Setting range	Factory setting
<b>[Acceleration]</b> ACC	1...180 s	15 s
<b>Acceleration ramp time</b> This parameter sets the ramp time from no torque to nominal torque. When the motor reaches established regime, the soft starter state changes to <b>[Bypassed]</b> <b>BYP</b> , even if the motor reaches established regime before the value set to <b>[Acceleration]</b> .		
<b>[Init Starting Torque]</b> TQ0	0...100% of nominal torque	20%
<b>Initial starting torque</b> Initial torque setting during the starting phase. If set too low, the motor may not start as soon as the RUN command is applied. <b>NOTE:</b> This parameter is visible if <b>[Control Mode]</b> is set to <b>[Torque Control]</b> .		

## Set Stop Profile

The following parameters can be used to control the stop of the motor.

There are two types of stop:

- **Freewheel:** No torque is applied to the motor by the soft starter. The motor stops in freewheel.
- **Deceleration:** The soft starter applies a decreasing torque / voltage to the motor to progressively decelerate it. The decreasing torque follows a defined ramp. This type of stop reduces the risk of water hammering with a pump and has no effect on high inertia applications.

Set the parameter **[Type of stop]** to define the type of stop:

- If you set **[Type of stop]** to **[Freewheel]** no other settings are required.
- If you set **[Type of stop]** to **[Deceleration]** then set the controlled deceleration time using **[Deceleration]** parameter and set the conditions for stopping in freewheel using **[End Of Deceleration]** parameter.

The set type of stop will be active at the next Stop order.

**NOTE:**

- Only one type of stop can be active at any given time.
- If a stop is given through the active command channel it will follow the configuration of **[Type of stop]**.
- If a stop is given by another active command channel than the active one it will be a **[Freewheel]**.
- There are also other possibilities when device is commanded by line channel. For more information, refer to the related communication guides.

Access path: **[Simply Start] → [Simply start]**

OR **[Complete settings] → [Start & Stop]**

Description	Setting range	Factory setting
<b>[Type of stop]</b> <i>STT</i>	–	<b>[Freewheel]</b> <i>F</i>
<b>Type of stop</b> <ul style="list-style-type: none"> <li>• <b>[Freewheel]</b> : Freewheel stop.</li> <li>• <b>[Deceleration]</b> : Soft stopping by control of torque.</li> </ul>		

ماکان کنترول

## Deceleration

Example with 80% of the nominal torque when a Stop order is applied:

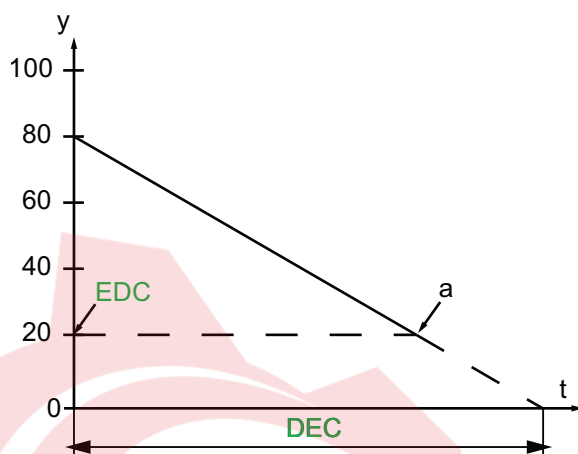

- y: Estimated torque (as a percentage of the nominal torque).
- a: End of controlled deceleration set by **[End Of Deceleration]**, motor stops in freewheel
- t: Time (s)
- DEC: **Deceleration ramp time**
- EDC: **End of controled deceleration threshold.**

Description	Setting range	Factory setting
<b>[Deceleration]</b> DEC	1...180 s	15 s
<p><b>Deceleration ramp time</b></p> <p>This parameter sets the deceleration ramp from the estimated applied torque at Stop order to no torque applied.</p> <p>Depending on the load characteristics, it is possible the motor may not stop to a standstill at the end of the ramp.</p> <p>This parameter can be accessed only if <b>[Type of stop]</b> or an error response is set to <b>[Deceleration]</b>.</p>		
<b>[End Of Deceleration]</b> EDC	0...100% of estimated torque when a Stop order is applied	20%
<p><b>End of controled deceleration threshold</b></p> <p>As soon as the estimated applied torque is below the value set in <b>[End Of Deceleration]</b> (point “a” in the figure above), the motor stops in freewheel.</p> <p>This parameter can be accessed only if <b>[Type of stop]</b> or an error response is set to <b>[Deceleration]</b>.</p>		

# Monitoring Settings

## What's in This Chapter

Motor Thermal Protection Class .....	118
Process Overload.....	122
Process Underload .....	124
Too Long Start.....	125
Phase Inversion .....	126
Time Before Restart .....	127
Phase Loss.....	128
Overvoltage & Undervoltage .....	128
Unbalanced Voltage & Unbalanced Current.....	131
Motor External Thermal Sensor .....	132
Gamma Sync.....	133

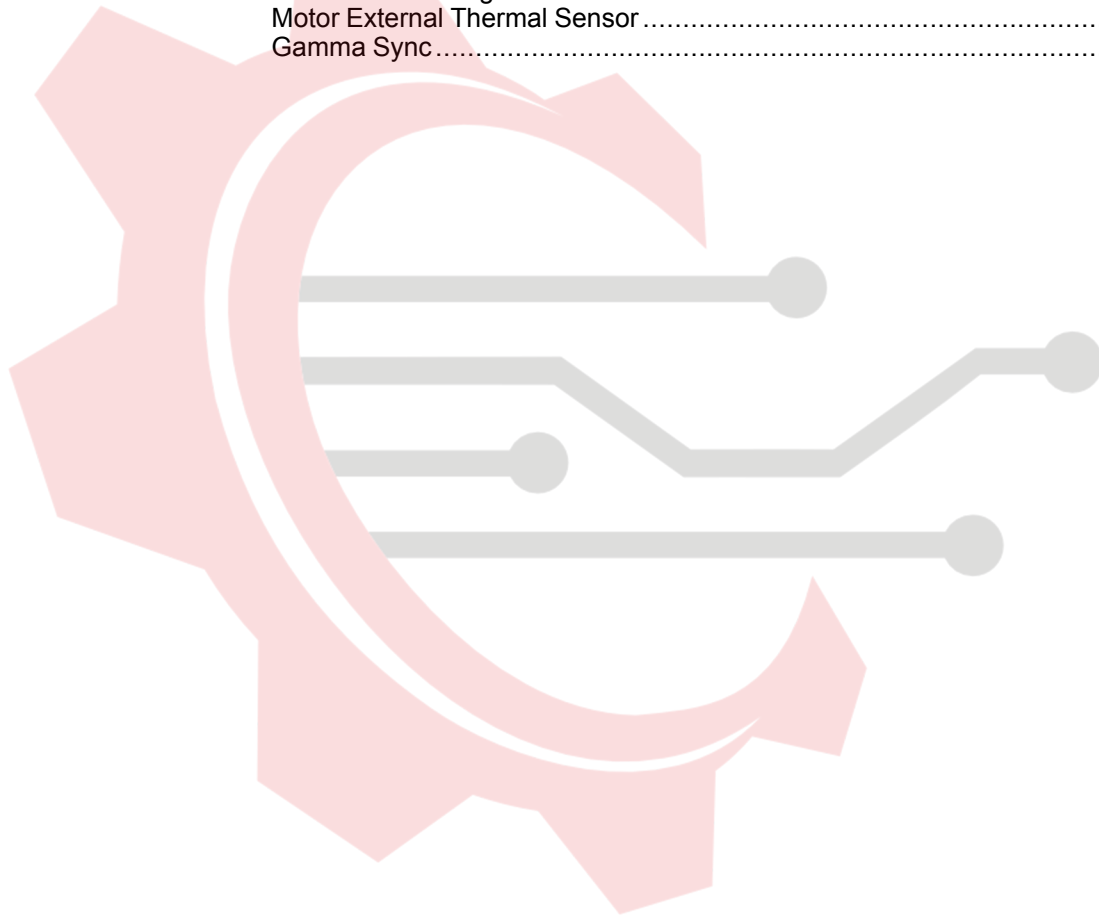

ماکان کنترول

# Motor Thermal Protection Class

## Introduction

The soft starter continuously calculates the temperature rise of the motor based on the controlled nominal current  $I_n$  and the actual current absorbed.

Temperature rises can be caused by a low or high overload with a long or short duration. The tripping curves on the following pages are based on the relationship between the actual current absorbed  $I$  and the (adjustable) nominal motor current  $I_n$ .

Standard IEC 60947-4-2 defines the protection classes providing the starting capacities of the motor (warm or cold start) without thermal detected errors. Different protection classes are given for a **cold** state (corresponding to a stabilized motor thermal state, switched off) and for a **warm** state (corresponding to a stabilized motor thermal state, at nominal power).

The soft starter factory setting of the protection **[Motor Class]** is **[Class 10E]**.

The thermal state displayed by the parameter **[Motor Therm State]** in the menu **[Display] → [Thermal Monitoring]** corresponds to the maximum of iron thermal state and copper thermal state:

- An overload warning is activated if the motor exceeds 110% of the motor thermal state, if the warning **[Motor Overload Warn]** is set in a warning group in the **[Diagnostics] → [Warnings]** menu.

The relay R2 can be assigned to the thermal detected error.

If the soft starter is switched-off, the thermal state is stored in EEPROM when the battery is present. When the soft starter is powered-on again, the duration of the power off is taken into account to calculate a new thermal state.

As long as the thermal state is above 110%, it is not possible to clear the detected error (except in case of power cycle of the soft starter).

If a special motor is used (flameproof, submersible, etc.) thermal monitoring should be provided by external thermal sensors.

ماکان کنترول

**Cold State**

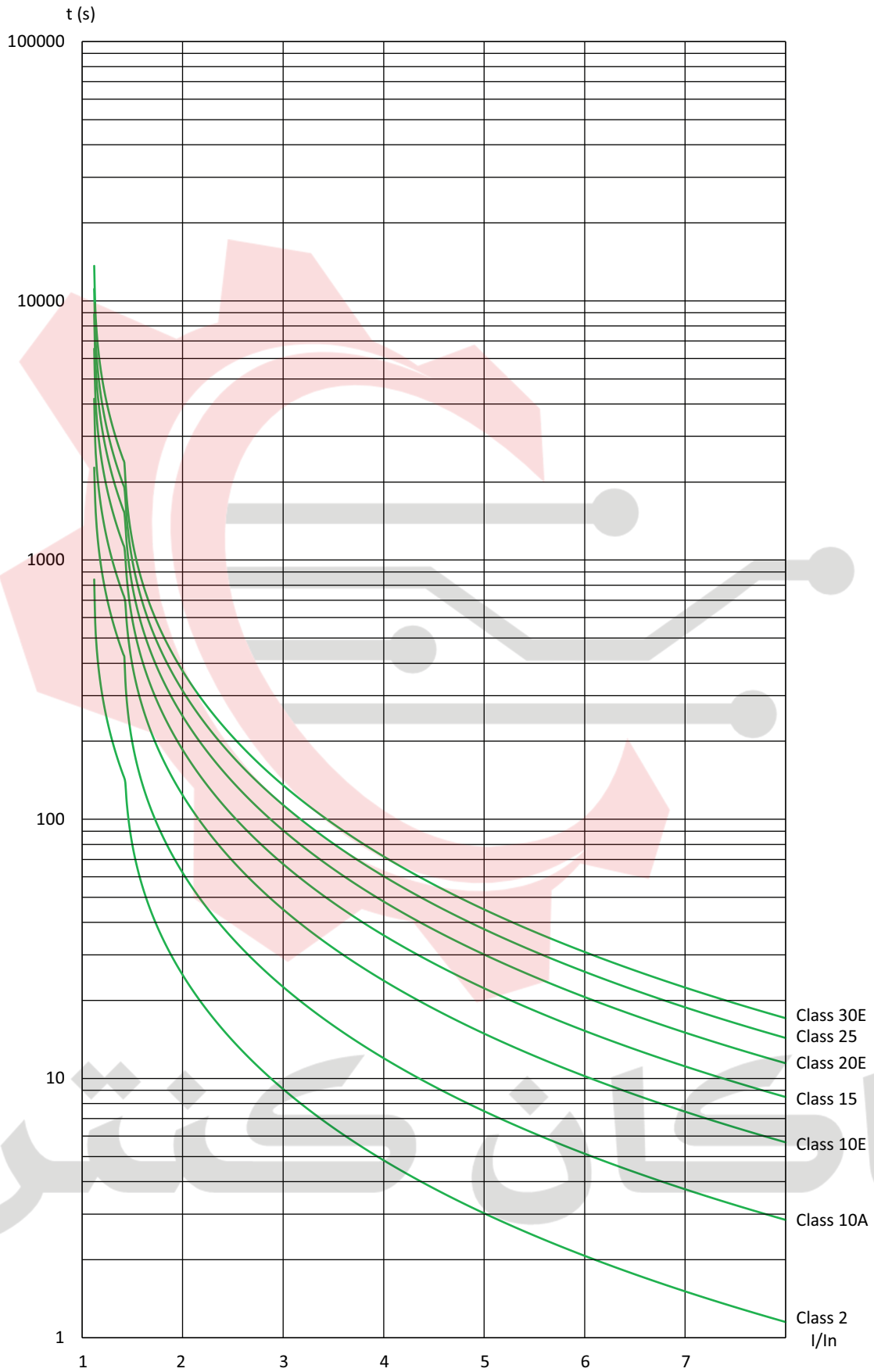

Triggering time for class 10E		Triggering time for class 20E	
3 In	5 In	3.5 In	5 In
45 s	16 s	62 s	30 s

**Warm State**

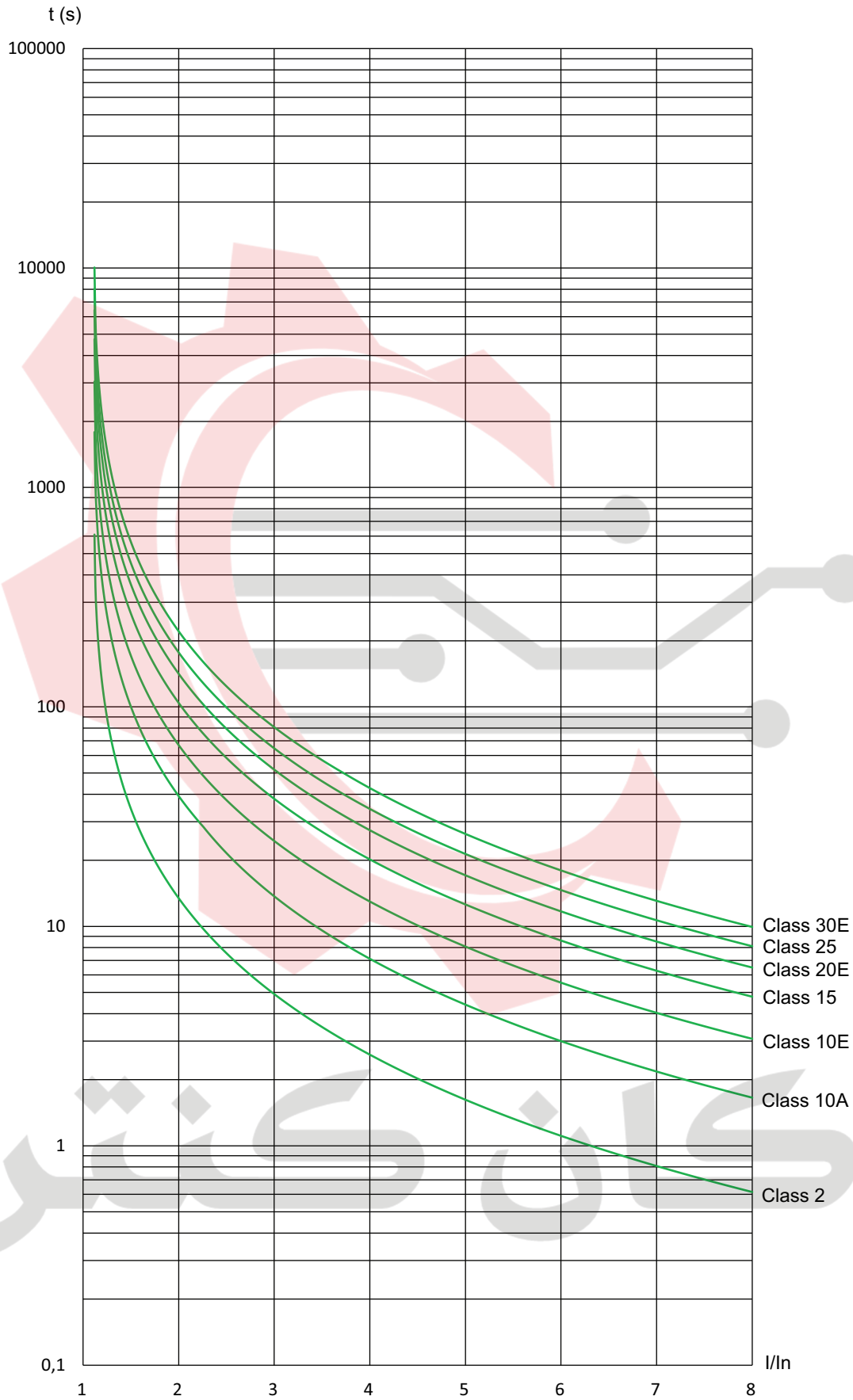

Triggering time for class 10E		Triggering time for class 20E	
3 I <sub>n</sub>	5 I <sub>n</sub>	3.5 I <sub>n</sub>	5 I <sub>n</sub>
25 s	8 s	36 s	18 s

## Commissioning

Access path: [Monitoring]

HMI label	Setting	Factory setting
[Motor Class] <i>THP</i>	–	[Class 10E] <i>10E</i>
<p><b>Motor thermal protection class</b></p> <p>Set your [Motor Class] from the motor name plate.</p> <ul style="list-style-type: none"> <li>• [No Protection]: no motor monitoring.</li> <li>• [Class 2] <i>sub-class 2</i>.</li> <li>• [Class 10A]</li> <li>• [Class 10E]</li> <li>• [Class 15].</li> <li>• [Class 20E]</li> <li>• [Class 25].</li> <li>• [Class 30E].</li> </ul>		

Access path: [Display] → [Thermal Monitoring]

HMI label	Display	Factory setting
[Motor Therm State] <i>THR</i>	0...300 %	–
<p><b>Motor thermal state</b></p> <p>This parameter monitors the motor thermal state. 100% corresponds to the nominal thermal state at the nominal motor current set to [Motor Nom Current].</p> <p>This estimation of the motor thermal state is done according to [Motor Class] configuration.</p>		

Access path: [Monitoring]

HMI label	Setting	Factory setting
[Mot Th State Reset] <i>RTHR</i>	[Yes] or [No]	[No]
<p><b>Reset motor thermal state</b></p> <p>This parameter resets the motor thermal state calculated by the soft starter.</p> <ul style="list-style-type: none"> <li>• [Yes]: Reset calculated motor thermal state.</li> <li>• [No]: Function inactive.</li> </ul>		
<b>NOTICE</b>		
<p><b>MOTOR OVERHEATING</b></p> <p>Only reset the motor thermal state when the motor is cold otherwise the estimation of the temperature of the motor will be incorrect.</p> <p><b>Failure to follow these instructions can result in equipment damage.</b></p>		

# Process Overload

This menu provides the parameters to configure the motor overload detection and management.

When the soft starter is in **[Bypassed]** state (established regime) and if the motor current exceeds the threshold set in **[Overload Threshold]** LOC for a duration longer than the value set in **[Ovld Detection Delay]** TOL, the soft starter behaves according to the value set in **[Overload ErrorResp]** ODL.

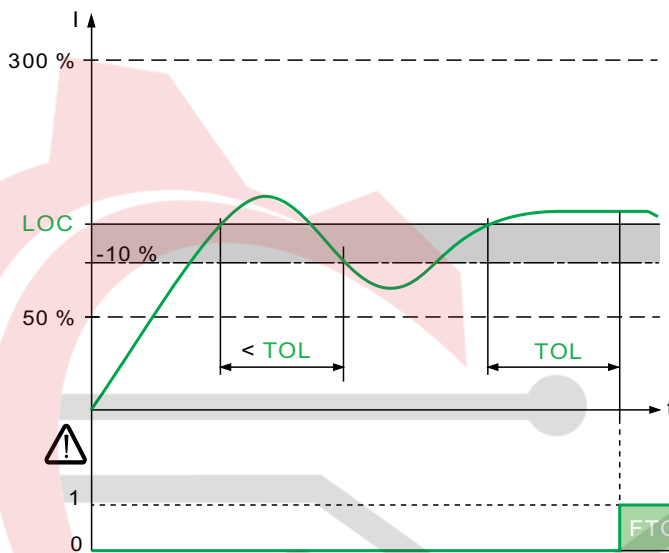

Access path: **[Monitoring]** → **[Process overload]**

HMI label	Setting	Factory setting
<b>[Overload Activation]</b> ODLA	<b>[No]</b> or <b>[Yes]</b>	<b>[No]</b>
<b>Overload activation</b> This parameter enables overload monitoring when the motor is active. The parameters <b>[Ovld Detection Delay]</b> , <b>[Overload Threshold]</b> and <b>[Overload ErrorResp]</b> are accessible for settings when <b>[Overload Activation]</b> is set to <b>[Yes]</b> .		
<b>[Overload Threshold]</b> LOC	50...300% of <b>[Motor Nom Current]</b>	80%
<b>Current overload threshold</b> This parameter is used to set the motor current threshold value for <b>[Overload Activation]</b> .		
<b>[Ovld Detection Delay]</b> TOL	0...60 s	10 s
<b>Overload detection delay</b> This parameter is to set the time delay to trigger the <b>[Process Overload]</b> error or the <b>[Proc Overload Warn]</b> when the <b>[Overload Threshold]</b> is reached. It is reset to zero if the current drops down below the value of <b>[Overload Threshold]</b> - 10% (hysteresis).		
<b>[Overload ErrorResp]</b> ODL	–	<b>[Ignore]</b>
<b>Response to overload error</b> This parameter sets the soft starter behavior when the motor current exceeds the threshold set in <b>[Overload Threshold]</b> for a duration longer than the value set in <b>[Ovld Detection Delay]</b> . <ul style="list-style-type: none"> <li><b>[Ignore]</b>: Trigger <b>[Proc Overload Warn]</b> OLA. The warning should be assigned to a warning group in <b>[Warn groups config]</b> to be visible when triggered. Refer to Warning Messages, page 226.</li> <li><b>[Freewheel Stop]</b>: Error <b>[Process Overload]</b> OLC is triggered and motor stops in freewheel.</li> </ul>		
<b>[Overload T.B.Rest.]</b> FTO	0...6 min	0 min

**Ovld time Before Restart**

This parameter sets the duration of the **[Process Overload]** error and can't be reset during this time.

This parameter is visible only if

- **[Overload Activation]** is set to **[Yes]**
- and **[Overload ErrorResp]** is set to **[Freewheel Stop]**



ماکان کنترول

## Process Underload

This menu provides the parameters to configure the motor underload detection and management.

When the soft starter is in **[Bypassed]** state (established regime) and if the motor torque is below the threshold set in **[Underload Threshold]** LUL for a duration longer than the value set in **[Unld Detect Delay]** ULT, the soft starter behaves according to the value set in **[Underload ErrorResp]** UDL.

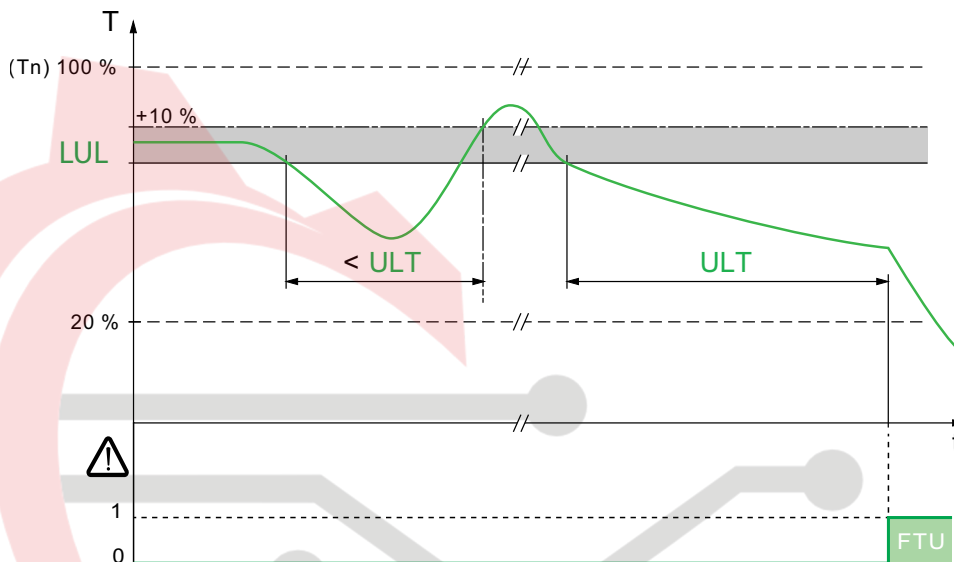

Access path: **[Monitoring]** → **[Process underload]**

HMI label	Setting	Factory setting
<b>[Underload Activation]</b> UDLA	<b>[Yes]</b> or <b>[No]</b>	<b>[No]</b>
<p><b>Underload activation</b></p> <p>This parameter enable underload monitoring when the motor is running.</p> <p>The parameters <b>[Unld Detect Delay]</b>, <b>[Underload Threshold]</b> and <b>[Underload ErrorResp]</b> are accessible for settings when <b>[Underload Activation]</b> is set to <b>[Yes]</b> .</p>		
<b>[Underload Threshold]</b> LUL	20...100% of the nominal torque	60%
<p><b>Underload threshold</b></p> <p>This parameter is used to set the motor torque threshold value for <b>[Underload Activation]</b>.</p>		
<b>[Unld Detect Delay]</b> ULT	0...60 s	60 s
<p><b>Motor underload time</b></p> <p>This parameter is used to set the time delay to trigger the <b>[Proc Underload]</b> error or <b>[Proc Undld Warn]</b> when the <b>[Underload Threshold]</b> is reached.</p> <p>It is reset to zero if the torque rises above the value of <b>[Underload Threshold]</b> + 10% (hysteresis).</p>		

HMI label	Setting	Factory setting
[Underload ErrorResp] UDL	—	[Ignore]
<p><b>Response to underload error</b></p> <p>This parameter sets the soft starter behavior when the motor torque is below the threshold set in [Underload Threshold] for a duration longer than the value set in [Undl Detect Delay].</p> <ul style="list-style-type: none"> <li>[Ignore]: Trigger [Proc Undld Warn] ULA. The warning should be assigned to a warning group in [Warn groups config] to be visible when triggered. Refer to Warning Messages, page 226.</li> <li>[Freewheel Stop]: Error [Proc Underload] ULF is triggered and motor stops in freewheel.</li> </ul>		
[Underload T.B.Rest.] FTU	0...6 min	0 min
<p><b>Undl time Before Restart</b></p> <p>This parameter sets the duration of the [Proc Underload] error and can't be reset during this time.</p> <p>This parameter is visible only if:</p> <ul style="list-style-type: none"> <li>[Underload Activation] is set to [Yes].</li> <li>and [Underload ErrorResp] is set to [Freewheel Stop].</li> </ul>		

## Too Long Start

These parameters allow to monitor and prevent excessively long start times for the soft starter.

Access path: [Monitoring]

HMI label	Setting	Factory setting
[Too Long Start] TLS	10...999 s or [No] NO	[No] NO
<p><b>Excessive starting time</b></p> <p>If the starting time exceeds the value set in [Too Long Start], the soft starter triggers the error [Too Long Start Err]. The conditions for the end of starting are:</p> <ul style="list-style-type: none"> <li>Mains voltage applied to the motor</li> <li>And motor current less than 2 In.</li> </ul> <p>This parameter can be set to:</p> <ul style="list-style-type: none"> <li>10...999 seconds.</li> <li>[No]: Excessive starting time monitoring deactivated.</li> </ul>		
[Long Start Error Resp] STB	—	[Freewheel Stop]
<p><b>Response to a too long start error</b></p> <p>This parameter sets the reaction for a too long start behavior.</p> <p>This parameter can be set to:</p> <ul style="list-style-type: none"> <li>[Freewheel Stop]: Error [Too Long Start Err] TLSF is triggered and motor stops in freewheel.</li> <li>[Deceleration]: Motor stops in deceleration and an error [Too Long Start Err] TLSF is triggered at the end of deceleration.</li> </ul> <p><b>NOTE:</b> This parameter can be accessed only if [Too Long Start] is not set to [No].</p>		

Access path: **[Display]** → **[Others]**

HMI label	Setting	Factory setting
<b>[Real Start Time]</b> <i>RSTT</i>	0...1000 s	–
This parameter shows the real start time to help define the value of <b>[Too Long Start]</b> parameter.		

## Phase Inversion

This parameter defines and monitors the direction of rotation of the motor in accordance to the mains.

Access path: **[Monitoring]**

HMI label	Setting	Factory setting
<b>[Phase Inversion Mon]</b> <i>PHR</i>	–	<b>[No]</b> <i>NO</i>
<p><b>Phase Inversion Monitoring</b></p> <p>If the mains input phases are not in the configured order, the soft starter triggers and displays the error <b>[Phase Inversion]</b>.</p> <ul style="list-style-type: none"> <li>• <b>[No]</b>: automatic detection, the first run order gives the direction.</li> <li>• <b>[123]</b>: direct network (L1 - L2 - L3).</li> <li>• <b>[321]</b>: indirect network (L3 - L2 - L1).</li> </ul>		

Access path: **[Display]** → **[Others]**

HMI label	Setting	Factory setting
<b>[Phase Direction]</b> <i>PHE</i>	–	–
<p><b>Detected phase direction</b></p> <p>Detect the phase inversion if <b>[Phase Inversion Mon]</b> <i>PHR</i> is configured.</p> <ul style="list-style-type: none"> <li>• <b>[No]</b>: No direction recognized.</li> <li>• <b>[123]</b>: direct network (L1 - L2 - L3).</li> <li>• <b>[321]</b>: indirect network (L3 - L2 - L1).</li> </ul>		

ماکان کنترول

# Time Before Restart

Access path: **[Monitoring]**

HMI label	Setting	Factory setting
<b>[Time Before Restart]</b> <i>TBS</i>	0...999 s	2 s

### Time before motor restart

This parameter sets the time delay between two starts. It helps to prevent too many starts in a short time which may overheat the motor.

**NOTE:** While the **[Time Before Restart]** *TBS* timer is running, the **[Wait for Restart]** *TBS* status is displayed on the graphic display terminal.

If the motor stops with :

- **[Type of stop]** set to **[Freewheel]** the time delay **[Time Before Restart]** starts when a Stop order is applied.
- **[Type of stop]** set to **[Deceleration]**, the time delay **[Time Before Restart]** starts as soon as the time, dependant of the setting **[End Of Deceleration]**, is elapsed.

In 2-wire control, the motor restarts if:

1. **[Time Before Restart]** is elapsed.
2. Run order is applied.

In 3-wire control, the motor restarts if:

1. **[Time Before Restart]** is elapsed.
2. Run order is present.

If the Run command is applied and maintained, the start of the motor can be delayed for the amount of time set to the parameter **[Time Before Restart]**

## ⚠ WARNING

### UNANTICIPATED EQUIPMENT OPERATION

- Verify that setting a high value to the parameter **[Time Before Restart]** does not result in unsafe conditions.
- Always consider that the equipment is in the operating state Operation Enabled as soon as a Run command is applied even if the time delay to restart is not elapsed.

**Failure to follow these instructions can result in death, serious injury, or equipment damage.**

ماکان کنترول

## Phase Loss

These parameters allow to define and monitor a motor loss of phase.

Access path: **[Monitoring]**

HMI label	Setting	Factory setting
<b>[Phase Loss Monit]</b> <small>PHP</small>	<b>[Yes]</b> or <b>[No]</b>	<b>[Yes]</b>
<b>Phase loss monitoring</b>		
 <b>⚠️ DANGER</b>		
<b>HAZARD OF ELECTRIC SHOCK, EXPLOSION OR ARC FLASH</b> If output phase monitoring is disabled, phase loss and, by implication, accidental disconnection of cables, are not detected. <ul style="list-style-type: none"> <li>Verify that the setting of this parameter does not result in unsafe conditions.</li> </ul> <b>Failure to follow these instructions will result in death or serious injury.</b>		
This parameter enables motor phase loss monitoring. If the motor current is below the threshold set in <b>[Phase Loss Thd]</b> and <b>[Phase Loss Monit]</b> is set to <b>[Yes]</b> , the soft starter triggers the <b>[Output Phase Loss]</b> error. <ul style="list-style-type: none"> <li><b>[No]</b>: phase loss monitoring disabled</li> <li><b>[Yes]</b>: phase loss monitoring enabled</li> </ul>		
<b>[Phase Loss Thd]</b> <small>PHL</small>	1...10% of soft starter current rating	5%
<b>Phase loss threshold</b>		
If the motor current drops down below this threshold on one phase, two or all three phases for 0.5 seconds, the soft starter triggers the <b>[Output Phase Loss]</b> error. This parameter is visible if <b>[Phase Loss Monit]</b> is set to <b>[Yes]</b> .		

More information on which phase/phases is/are lost available in chapter Diagnostic Data, page 211.

## Overvoltage & Undervoltage

Undervoltage and overvoltage will modify the consumption of current, may cause overheating, and affect the efficiency and motor lifetime.

### Overvoltage

If the mains voltage exceeds the threshold set in **[Overvoltage Thld]** OSD for a duration longer than the value set in **[OV detection delay]** OSFD, the soft starter behaves according to the value set in **[Voltage Error Resp]** MVFB.

Access path: **[Monitoring]** → **[Overvoltage]**

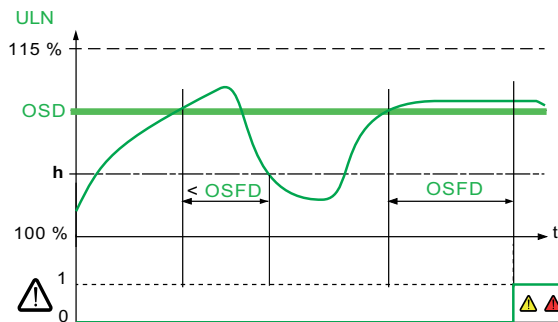

**Legend:**

- h: the timer [OV detection delay] is reset to zero if the voltage drops below 95 % of [Overvoltage Thld].
- : [Overvoltage Warn]
- : [Mains Nom. Volt. Error]

HMI label	Setting	Factory setting
[Overvoltage Thld] OSD	110...115% of <i>Mains voltage</i> ULN	110%
<b>Overvoltage threshold</b>		
This parameter is used to set the mains voltage threshold value for triggering a [Mains Nom. Volt. Error] NOSF error.		
[OV detection delay] OSFD	1...10 s	2 s
<b>Overvoltage detection delay</b>		
This parameter is used to set the time delay to trigger an [Mains Nom. Volt. Error] NOSF error when the [Overvoltage Thld] is reached.		
The timer [OV detection delay] is reset to zero if the voltage drops below 95 % of [Overvoltage Thld].		
[Voltage Error Resp] MVFB	–	[Ignore]
<b>Response to an under/overvoltage error</b>		
This parameter sets the soft starter behavior when the mains voltage exceeds the threshold set in [Overvoltage Thld] for a duration longer than the value set in [OV detection delay].		
<ul style="list-style-type: none"> <li>• [Ignore]: Trigger [Overvoltage Warn] OSA. The warning should be assigned to a warning group in [Warn groups config] to be visible when triggered. Refer to Warning Messages, page 226.</li> <li>• [Freewheel Stop]: Error [Mains Nom. Volt. Error] NOSF is triggered and motor stops in freewheel.</li> <li>• [Configured Stop]: Motor stops according to the value set in [Type of stop], [Overvoltage Warn] is triggered.</li> <li>• [Deceleration]: Motor stops in deceleration and an error [Mains Nom. Volt. Error] NOSF is triggered at the end of deceleration.</li> </ul>		

## Undervoltage

If the mains voltage is below the threshold set in [Undervoltage Thld] USD for a duration longer than the value set in [UV Detection Delay] USFD, the soft starter behaves according to the value set in [Voltage Error Resp] MVFB.

Access path: [Monitoring] → [Undervoltage]

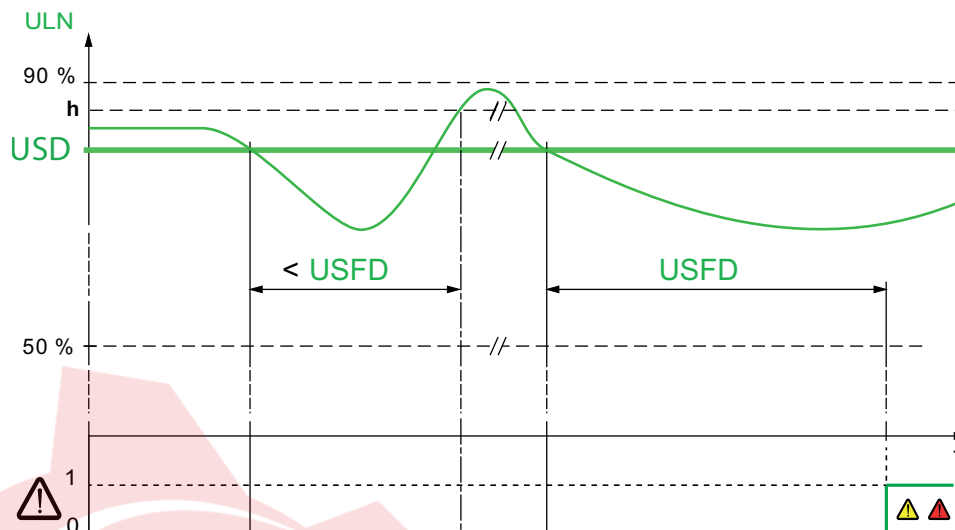

**Legend:**

- **h:** the timer **[UV Detection Delay]** is reset to zero if the voltage exceeds 105 % of **[Undervoltage Thld]**.
- : **[UnderV Warn]**
- : **[Supply Mains UnderV]**

HMI label	Setting	Factory setting
<b>[Undervoltage Thld]</b> USD	50...90% of <i>Mains voltage</i> ULN	85%
<b>Undervoltage threshold</b>		
This parameter is used to set the mains voltage threshold value for triggering a <b>[Supply Mains UnderV]</b> USF error.		
<b>[UV Detection Delay]</b> USFD	1...60 s	5 s
<b>Undervoltage detection delay</b>		
This parameter is used to set the time delay to trigger a <b>[Supply Mains UnderV]</b> USF error. when the <b>[Undervoltage Thld]</b> is reached.		
The timer <b>[UV Detection Delay]</b> is reset to zero if the voltage exceeds 105 % of <b>[Undervoltage Thld]</b> .		
<b>[Voltage Error Resp]</b> MVFB	–	<b>[Ignore]</b>
<b>Response to an under/overvoltage error</b>		
This parameter sets the soft starter behavior when the mains voltage is below the threshold set in <b>[Undervoltage Thld]</b> for a duration longer than the value set in <b>[UV Detection Delay]</b> .		
<ul style="list-style-type: none"> <li>• <b>[Ignore]:</b> Trigger <b>[UnderV Warn]</b> USA. The warning should be assigned to a warning group in <b>[Warn groups config]</b> to be visible when triggered. Refer to Warning Messages, page 226.</li> <li>• <b>[Freewheel Stop]:</b> Error <b>[Supply Mains UnderV]</b> USF is triggered and motor stops in freewheel.</li> <li>• <b>[Configured Stop]:</b> Motor stops according to the value set in <b>[Type of stop]</b>, <b>[UnderV Warn]</b> is triggered.</li> <li>• <b>[Deceleration]:</b> Motor stops in deceleration and an error <b>[Supply Mains UnderV]</b> USF is triggered at the end of deceleration.</li> </ul>		

## Unbalanced Voltage & Unbalanced Current

### Unbalanced Voltage

Access path: **[Monitoring]**

HMI label	Setting	Factory setting
<b>[Volt Unbalance Thld]</b> MVUT	5...10.00% of <b>[Mains Voltage]</b>	5%
<p><b>Mains unbalance threshold</b> This parameter is used to set the mains unbalance threshold value.</p> <p>If the <b>[Mains Unbalance Ratio]</b> UMV exceeds the threshold set in <b>[Volt Unbalance Thld]</b>, a warning <b>[Volt Unbalance Warn]</b> ULBA is triggered.</p>		

### Unbalanced Current

Access path: **[Monitoring]**

HMI label	Setting	Factory setting
<b>[Curr Unbalance Thld]</b> CURT	5...60.00% or <b>[No]</b> NO	<b>[No]</b>
<p><b>Current unbalance alarm threshold</b> This parameter is used to set the current unbalance threshold value.</p> <p>The current unbalance ratio <b>[Current Unbalance]</b> defined by <i>Negative sequence current Magnitude</i>/ <i>(Positive sequence current magnitude)*100</i>, is compared to the threshold <b>[Curr Unbalance Thld]</b> to trigger a warning <b>[Curr Unbal Warn]</b> ILBA, if threshold is exceeded for the duration of <b>[Curr Unbalance Delay]</b>.</p>		
<b>[Curr Unbalance Delay]</b> CURD	1...60s	10s
<p><b>Current unbalance alarm Delay</b> This parameter is used to set the time delay to trigger a warning <b>[Curr Unbal Warn]</b> ILBA when the <b>[Curr Unbalance Thld]</b> is exceeded.</p>		

ماکان کنترول

## Motor External Thermal Sensor

A thermal sensor fixed on a motor can be connected on the soft starter. By enabling this capability, the soft starter measures the temperature of the motor according to the sensor type and connection.

The menu **[Thermal monitoring]** provides the parameters to measure a temperature with a thermal sensor wired of the PTC1 terminal (cabinet, a room, etc...).

PTC thermal sensor is supported by this function.

The function gives the possibility to manage 2 types of monitoring:

- the soft starter triggers a warning without stopping the application.
- the soft starter triggers an error and stops the application.

The monitoring function takes into account the following events:

- Overheating
- Sensor break (loss of signal)
- Sensor short-circuit

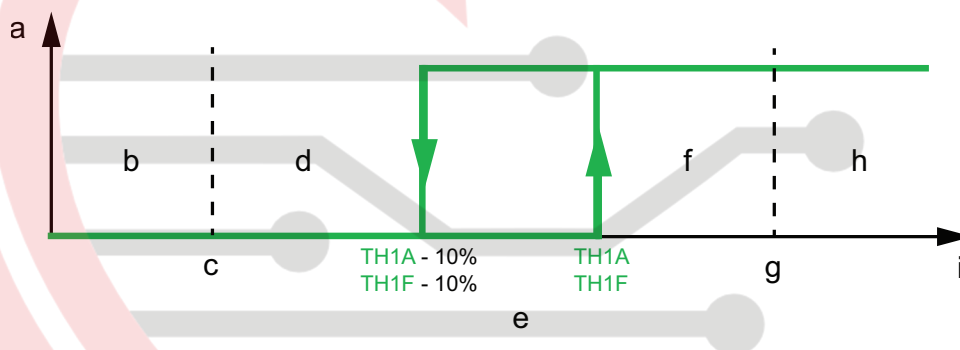

- (a): Thermal sensor state.
- (b): Short circuit.
- (c): Short circuit level.
- (d): Cold.
- (e): Hysteresis.
- (f): Hot
- (g): Open circuit level.
- (h): Open circuit.
- (i): Thermal sensor value.

**NOTE: [Thermal monitoring]** does not deactivate the motor thermal monitoring provided by the calculation. Both types of monitoring can operate in parallel.

## PTC Thermal Sensor Wiring

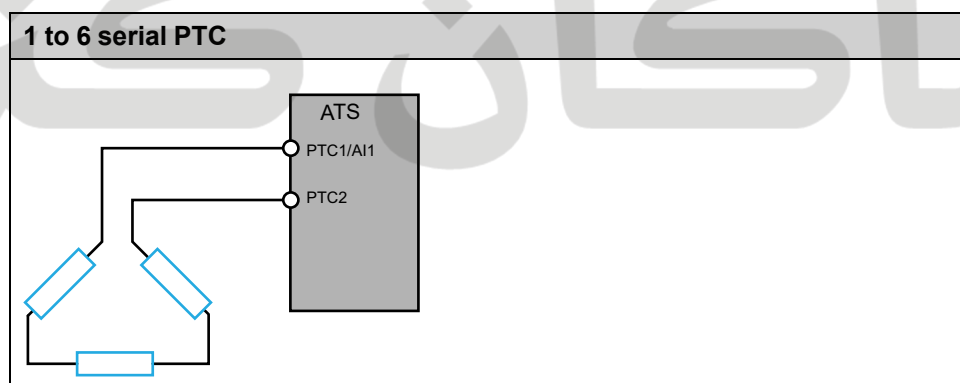

Access path: [Monitoring]

HMI label	Setting	Factory setting
[AI1 Th Monitoring] <span style="color: green;">TH1S</span>	–	[Not Configured] <span style="color: green;">NO</span>
<p><b>Activation of the thermal monitoring on AI1</b></p> <p>This parameter enables the thermal sensor monitoring from thermal sensor PTC on the terminal PTC1.</p> <ul style="list-style-type: none"> <li>• <b>[Not Configured]</b>: Disable thermal monitoring on PTC1.</li> <li>• <b>[AI1]</b>: Enable thermal monitoring on PTC1 and trigger an error on detection</li> </ul>		
[AI1 filter] <span style="color: green;">AI1F</span>	0...10 s	0 s
<p><b>AI1 filter</b></p> <p>This parameter set the cutoff time of the low pass filter for PTC1.</p> <p>The low pass filter aims to suppress electric noise of the thermal sensor and avoid interference issue in the input signal.</p> <p>This parameter can be accessed if <b>[AI1 Th Monitoring]</b> is set to <b>[AI1]</b>.</p>		
[AI1 Th Error Resp] <span style="color: green;">TH1B</span>	–	[Freewheel Stop] <span style="color: green;">YES</span>
<p><b>Response to thermal error for AI1</b></p> <p>This parameter sets the behavior of the soft starter when the threshold set in <b>[AI1 Th Error Level]</b> is reached on the terminal PTC1 / AI1.</p> <ul style="list-style-type: none"> <li>• <b>[Ignore]</b>: Trigger <b>[AI1 Th Warning]</b> <span style="color: green;">TP1A</span> or <b>[Temp Sens AI1 Warn]</b> <span style="color: green;">TS1A</span>. The warning should be assigned to a warning group in <b>[Warn groups config]</b> to be visible when triggered. Refer to Warning Messages, page 226.</li> <li>• <b>[Freewheel Stop]</b>: Error <b>[AI1 Th Level Error]</b> <span style="color: green;">TH1F</span> is triggered and motor stops in freewheel.</li> <li>• <b>[Configured Stop]</b>: Motor stops according to the value set in <b>[Type of stop]</b>, <b>[AI1 Th Warning]</b> <span style="color: green;">TP1A</span> or <b>[Temp Sens AI1 Warn]</b> <span style="color: green;">TS1A</span> is triggered.</li> <li>• <b>[Deceleration]</b>: Motor stops in deceleration and an error <b>[AI1 Th Level Error]</b> <span style="color: green;">TH1F</span> is triggered at the end of deceleration.</li> </ul> <p><b>NOTE:</b> For <b>[AI1 Th Error Resp]</b> to be visible, it is necessary to set:</p> <ul style="list-style-type: none"> <li>• <b>[AI1 Th Monitoring]</b> to <b>[AI1]</b>.</li> <li>• <b>[AI1 Type]</b> to <b>[PTC]</b>.</li> </ul>		

## Gamma Sync

Access path: [Monitoring]

HMI label	Setting	Factory setting
[Gamma Sync Enable] <span style="color: green;">GSEA</span> 	[Yes] or [No]	[Yes]
<p><b>Gamma synchronization Equilibrium Activation</b></p> <p>This parameter enables the detection of a balance in each phase current conduction.</p> <ul style="list-style-type: none"> <li>• <b>[Yes]</b> : desynchronization detection enabled. In case of a desynchronization detected, the error <b>[SCR Sync Error]</b> <span style="color: green;">SDF</span> is triggered.</li> <li>• <b>[No]</b> : desynchronization detection disabled.</li> </ul>		

## Other Settings

### What's in This Chapter

Mains Frequency.....	135
Set The Mains Voltage.....	136
Mains Contactor Command .....	137

These parameters allow access to other settings for fine-tuning.

To access to this menu, the **[Access Level]** needs to be set to **[Standard]** or to **[Expert]**.



ماکان کنترول

## Mains Frequency

Access path: **[Complete settings]** → **[Motor parameters]**

HMI label	Setting	Factory setting
<b>[Mains Frequency]</b> <small>FRC</small>	–	<b>[Auto]</b> <small>AUTO</small>
<p><b>Mains frequency</b></p> <p>Set the expected mains frequency.</p> <ul style="list-style-type: none"> <li>• <b>[Auto]</b>: Automatic recognition of the mains frequency, tolerance of 5%</li> <li>• <b>[50Hz]</b>: Expected frequency at 50 Hz, tolerance of 20%</li> <li>• <b>[60Hz]</b>: Expected frequency at 60 Hz, tolerance of 20%</li> </ul> <p>If the mains frequency goes out of the tolerance of the expected frequency, a <b>[Mains Freq Error]</b> error triggers.</p>		



ماکان کنترول

## Set The Mains Voltage

Mains Voltage is used as an input for several monitoring functions as Overvoltage, Undervoltage and many other functions.

The estimated mains voltage and motor power can be consulted in the **[Display]** menu.

**[Complete settings] → [Motor parameters]**

Description	Setting range	Factory setting
<b>[Mains Voltage]</b> <small>ULN</small>	170...660 V	400 V
<i>Mains voltage</i> of the soft starter.		

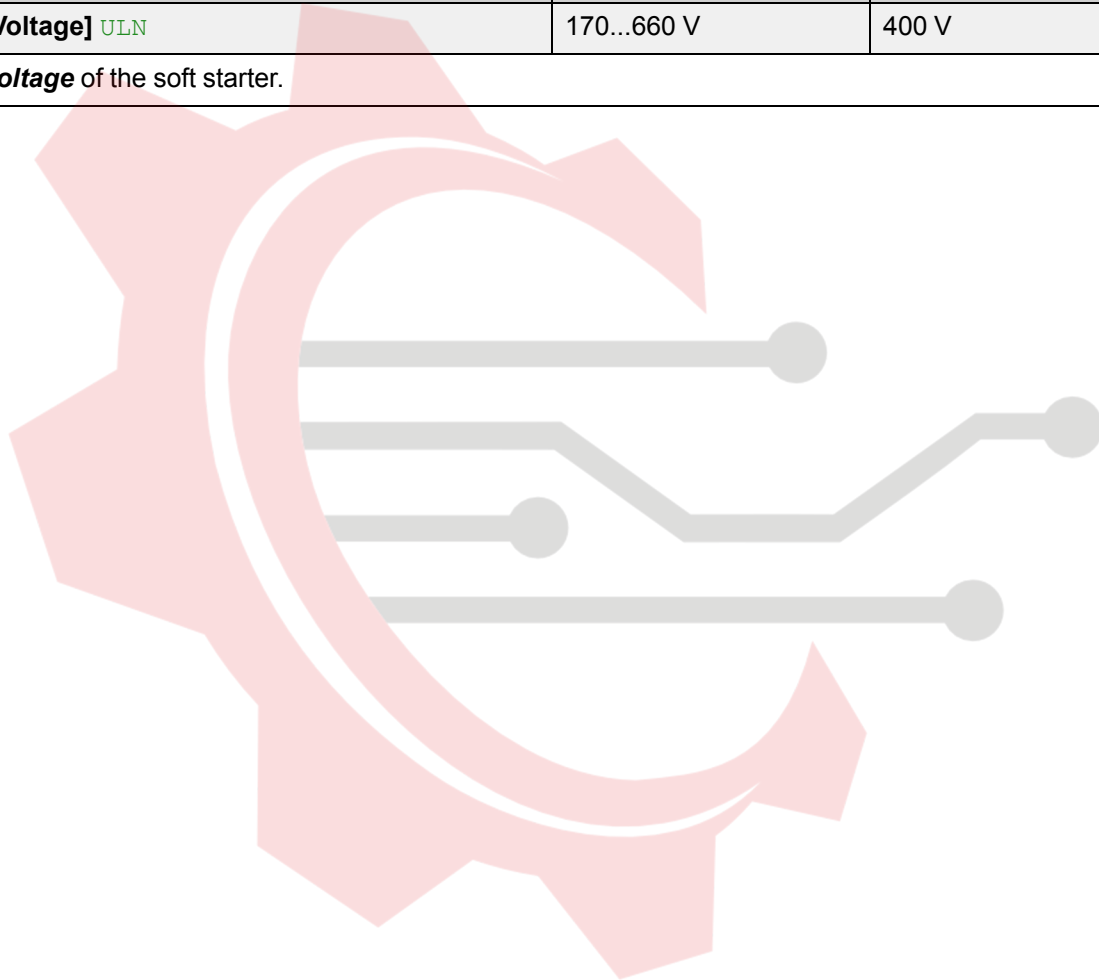

ماکان کنترول

# Mains Contactor Command

This menu provides the parameters to manage a line contactor upstream the soft starter. Refer to Application Diagrams, page 34.

Access path: **[Complete settings] → [Mains contactor cmd]**

HMI label	Setting	Factory setting
<b>[Mains Contactor]</b> LLC	<b>[Not Assigned]</b> NO , [R1] or [R2]	<b>[Not Assigned]</b> NO

### Mains contactor control

This parameter sets the external mains supply contactor command. The soft starter can command an external contactor placed upstream in the main supply via the relay R1 or R2, allowing to close or open the mains supply of the soft starter with a relay command.

If the function **[Mains Contactor]** LLC is set to R1, a factory settings will reset R1 to **[Operating State Fault]** and could apply, depending on the wiring diagram, voltage on the mains supply inputs via the mains contactor.

 **DANGER**

**UNINTENDED PRESENCE OF VOLTAGE ON THE MAINS SUPPLY INPUTS**

- Verify that restoring to factory setting when **[Mains Contactor]** LLC is set to R1 does not result in unsafe conditions.
- In case of doubt, prefer to set the parameter **[Mains Contactor]** LLC to another relay output.

**Failure to follow these instructions will result in death or serious injury.**

The relay command is based on the Run / Stop commands and the detected errors:

- The external contactor command is activated by a Run or Pre-heating command
- The mains contactor output is deactivated:
  - At the end of a deceleration or when the motor switches to freewheel after a Stop command.
  - When an error is detected.

**NOTE:** when line contactor is configured, the run command is considered in **NLP** state.

<b>[Device Lock]</b> LES	–	<b>[Not Assigned]</b> NO
--------------------------	---	--------------------------

### Device lock assignment

This parameter sets a digital input, or a virtual input via the CMD word, to lock the device. When this input is activated (Low level on digital inputs, high level on virtual inputs), the relay assigned to **[Mains Contactor]** is forced to open, which opens the mains contactor and stops the motor in freewheel.

To restart the motor, deactivate the digital input command and apply a new Run order.

- **[Not Assigned]**: No input assigned.
- **[DI●]** : Digital input DI● assigned.
- **[CD●●]** : Assigned to line channel.

This parameter can be accessed if **[Mains Contactor]** is set to **[R1]** or **[R2]**. **[Device Lock]** does not affect the emergency stop switch.

<b>[Mains V. time out]</b> LCT	1...999 s	5 s
--------------------------------	-----------	-----

### Mains V. time out

This parameter sets the time before triggering the error:

- **[Input Contactor]** LCF if the soft starter does not detect the mains after mains contactor activation.
- **[Input Contact. Closed]** LCCF if the soft starter detects the mains after mains contactor deactivation.

**NOTE:** If mains contactor relay is closed at power on, error **[Input Contact. Closed]** LCCF is not managed, soft starter can be in **RDY** state.

## Small Motor Test

This function can be used to validate the wiring of the soft starter by rotating a small motor that is a fraction of the soft starter rating.

The following table gives the minimum motor power required for the small motor function depending on the soft starter reference. The small motor function is not guaranteed to operate correctly if these minimum ratings are not followed :

Mains supply (Vac)	Minimum motor power			
	For ATS430-D17...C17S6	For ATS430C21-S6	For ATS430-C25...C41S6	For ATS430-C48...C59S6
208	2,2kW	5,5kW	7,5kW	5,5kW
230	3kW	7,5kW	9kW	7,5kW
380	4kW	11kW	15kW	11kW
400	4kW	15kW	15kW	15kW
440	5,5kW	15kW	15kW	15kW
500	5,5kW	15kW	18,5kW	15kW
600	7,5kW	18,5kW	22kW	18,5kW

### NOTE:

When **[Small Motor Test]** is set to **[Yes]**:

- **[Phase Loss Monit]** is set to **[No]** , phase loss monitoring is disabled.
- **[Control Mode]** parameter is forced to **[Voltage Control]**.

## ⚠ WARNING

### TEMPORARY MODIFICATION OF THE BEHAVIOR

- Only use this function for test and maintenance purposes.
- Verify that disabling phase loss detection does not result in unsafe conditions.

**Failure to follow these instructions can result in death, serious injury, or equipment damage.**

**NOTE:** The **[Small Motor Test]** test function is set to **[No]** when the soft starter control supply is disconnected. Upon next power-up the soft starter, including **[Phase Loss Monit]** and **[Control Mode]**, will return to its previous configuration.

Step	Action
1	Wire a small motor, refer to the ratings table above.
2	Set <b>[Small Motor Test]</b> to <b>[Yes]</b> .
3	To start the test, apply a Run command to the soft starter by pressing the <b>RUN</b> button on the display terminal ( <b>[HMI]</b> as command channel) or via the STOP and RUN control terminals ( <b>[Terminal]</b> as command channel).
4	To stop the test, apply a Stop command to the soft starter by pressing the <b>STOP / RESET</b> button on the display terminal or via the STOP and RUN control terminals.

Description	Setting range	Factory setting
[Small Motor Test] SST	–	[No]
<p><b>Small motor test</b></p> <p>Access path: [Complete settings]</p> <ul style="list-style-type: none"> <li>[Yes]: Ready to start the test, apply a Run command</li> <li>[No]: Function inactive, the soft starter will start normally when a Run command is applied</li> </ul> <p>During the test, the display terminal displays the state [Small Motor Test] instead of the [Ready] state.</p> <p>When [Small Motor Test] is set to [Yes]:</p> <ul style="list-style-type: none"> <li>[Phase Loss Monit] is set to [No] , phase loss monitoring is disabled.</li> <li>[Control Mode] parameter is forced to [Voltage Control].</li> </ul>		

### Particular case : Test the power connection with small motor test in “Initial setup” :

Step	Action
1	Wire the mains and the motor side on the soft starter and supply in 208.600 Vac, following the small motor supply voltage.
2	In the [Initial Setup] menu, scroll to [Small Motor Test] and press OK. <b>Result:</b> An instruction message is displayed on the display terminal.
3	Give a Run command to check the motor behavior. Give a Stop order to stop the motor.
4	To leave the [Small Motor Test] function, turn Off and Turn On the device control supply or press ESC. <b>Result:</b> The [Initial Setup] is displayed.

ماکان کنترول

# Torque / Voltage Control

The start and controlled stop profiles follow a motor control algorithm, active either on a torque profile or on a voltage profile. This function can be used to choose torque or voltage profile to control the motor start and stop.

Torque control is specified for pumps, fans with belts, circular saws and limits:

- Jerk when the motor starts
- Hammering effect
- Sliding effect

Voltage control is specified for motors in parallel on one soft starter.

With torque control, the start and stop of the motor can be set via the **[Simply Start]** menu, for more information refer to **Simply Start**, page 111.

With voltage control, the start and stop of the motor can be set via the **[Simply Start]** menu and the parameter **[Init Starting Voltage]** must be considered, for more information refer to **Voltage Boost**, page 150.

Access path: **[Complete settings] → [Start & Stop]**

Description	Setting range	Factory setting
<b>[Control Mode]</b> CLP	<b>[Torque Control]</b> TC or <b>[Voltage Control]</b> VC	<b>[Torque Control]</b> TC
<b>Control mode</b>		
<ul style="list-style-type: none"> <li>• <b>[Torque Control]</b>: Activate torque control.</li> <li>• <b>[Voltage Control]</b>: Activate voltage control.</li> </ul>		
<b>Acceleration with torque control:</b>		<b>Acceleration with voltage control:</b>
<ul style="list-style-type: none"> <li>• y: Reference torque as % of nominal torque</li> <li>• t: Time (s)</li> <li>• TQ0: <b>Initial starting torque</b></li> <li>• ACC: <b>Acceleration ramp time</b></li> </ul> <p>More information about <b>Initial starting torque</b> and <b>Acceleration ramp time</b> in <b>Set Start Profile</b>, page 114.</p>		<ul style="list-style-type: none"> <li>• y: Reference voltage as % of nominal voltage</li> <li>• t: Time (s)</li> <li>• V0: <b>Initial starting voltage</b></li> <li>• ACC: <b>Acceleration ramp time</b></li> </ul>

<b>[Init Starting Voltage]</b> $v_0$	25%...49% of <b>[Mains Voltage]</b> $U_{LN}$	49%
--------------------------------------	--	-----

**Initial starting voltage**

Set **[Init Starting Voltage]** level between 25% and 49% of **[Mains Voltage]**. The set value must be high enough to create a torque superior to the resistive torque.

This parameter is visible if **[Control Mode]** is set to **[Voltage Control]**.

The function **[Boost]** can be used to provide a boost at the start to overcome a mechanical hard point. More information about **Voltage boost level** in Voltage Boost, page 150

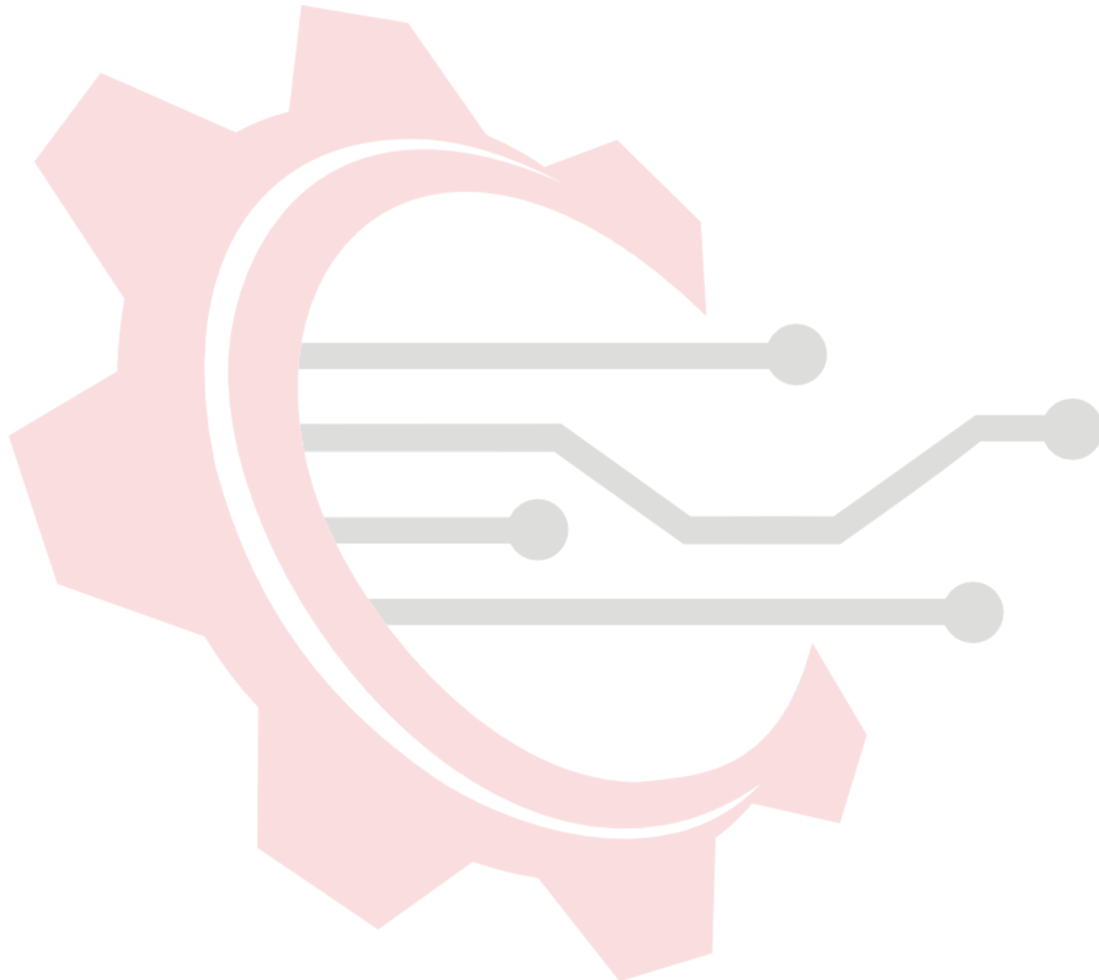

# ماکان کنترول

# Start and Stop

Start profile (Set Start Profile, page 114) and Stop profile (Set Stop Profile, page 115) are set in the **[Simply start]** menu. Additional features can be set :

Enhance the motor control :

HMI label	Setting	Factory setting
<b>[Torque Limit]</b> <small>TLI</small> 	10...200% of nominal torque or <b>[No]</b>	<b>[No]</b>

### Torque limit

This parameter:

- Set the final torque of the torque-controlled acceleration when **[Control Mode]** it set to **[Torque Control]**.
- Limit the torque reference to avoid regenerative behavior in applications with high inertia.
- Can be used for constant starting torque if **[Init Starting Torque] = [Torque Limit]** and if the application load is compliant.

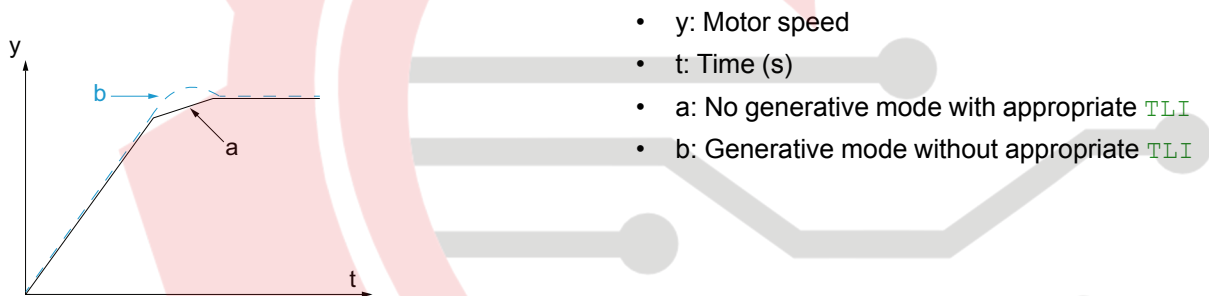

- y: Motor speed
- t: Time (s)
- a: No generative mode with appropriate TLI
- b: Generative mode without appropriate TLI

This parameter can be accessed if **[Control Mode]** is set to **[Torque Control]**.

HMI label	Setting	Factory setting
<b>[Stator Loss Comp]</b> <small>LSC</small> 	0...90 %	25 %

### Stator loss compensation

#### Only in torque control

In the event of torque oscillations, reduce this parameter gradually until the motor is properly operating. Oscillations are most common if the soft starter is connected in the motor delta winding or with motors with excessive slip. Modifying this parameter has an impact on torque estimation.

ماکان کنترول

# Motor Preheating

By applying a current inside the motor windings, the preheating function can be used before starting the motor to:

- Unfreeze the motor.
- Help to prevent temperature deviations and condensation.
- Start the motor at the same temperature to limit the variations between cold and warm state.

**NOTE:** [Time Before Preheat] should be set to ensure that the motor stops before preheating.

During preheating, the motor thermal monitoring function is not active.

<b>NOTICE</b>
<p><b>MOTOR OVERHEATING</b></p> <ul style="list-style-type: none"> <li>• Verify that the connected motor is properly rated for the current to be applied in terms of amount and time.</li> <li>• Add an external thermal sensor to monitor the temperature of the motor if preheating operation can result in motor windings overheating.</li> </ul> <p><b>Failure to follow these instructions can result in equipment damage.</b></p>

To monitor the motor temperature, use an external thermal sensor:

- Wire it to the soft starter PTC1 terminal and set the thermal monitoring, refer to Motor External Thermal Sensor, page 132.
- Set relay R2 to [Motor Overload Warn].

The preheating function is not compatible with:

- 2-wire control, refer to RUN and STOP Management, page 41 for more information.

For the complete list of incompatibilities, refer to Functions Compatibility Table, page 151.

**NOTE:** When using the [CD●●] activation and [Control Mode] set to [Standard Profile], the *Halt* command must be active to remain in the 5 - *Operation enabled* state. For further information, please refer to the associated communication manuals.

## Use the preheating function by:

<b>Continuous preheating ([Yes])</b>	<b>[DI●] or [CD●●] activation</b>
The preheating is done automatically when product is in ready state.	The preheating is done by applying a high level on the digital input assigned to [Preheating Assign] when motor is stopped.  <b>NOTE:</b> When using activation through line channel ([CD●●] and [Control Mode] is set to [Standard Profile], the <i>Halt</i> command must be active to remain in the "5 - <i>Operation enabled</i> " state. For further information, please refer to the associated fieldbus manual.
The preheating is effective when [Time Before Restart] and [Time Before Preheat] are elapsed after a stop of the motor.	
The status [Motor Preheating] <span style="color: green;">HEA</span> is displayed on the display terminal, even during [Time Before Restart].	
Apply a Stop order to stop the preheating.	The preheating stops by applying and maintaining a low level on the digital or virtual input set to [Preheating Assign] when the product is in ready state, or by applying a Stop order

## Using the function with a digital input in terminal control

Step	Action
1	Set <b>[Preheating Assign]</b> to a digital input.
2	Set the heating current level <b>[Preheat Level]</b> .
3	Set the time delay before the preheating start <b>[Time Before Preheat]</b> . The <b>[Time Before Preheat]</b> counting start when the motor is stopped. The motor will not preheat as long <b>[Time Before Preheat]</b> and <b>[Time Before Restart]</b> are not elapsed.
4	To start the preheating: <ul style="list-style-type: none"> <li>• The motor must be stopped.</li> <li>• <b>[Time Before Restart]</b> must be elapsed.</li> <li>• <b>[Time Before Preheat]</b> is elapsed.</li> <li>• Apply and maintain a high level on the DI1 terminal (depends on wire management).</li> <li>• Apply and maintain a high level on the digital input set to <b>[Preheating Assign]</b> in step 1.</li> </ul> The status <b>[Motor Preheating]</b> is displayed on the display terminal.
5	To stop the preheating: <ul style="list-style-type: none"> <li>• Apply and maintain a low level on the digital or virtual input set to <b>[Preheating Assign]</b>.</li> <li>• Or apply a Run order.</li> <li>• Or apply a Stop order.</li> </ul>

ماکان کنترول

**Example of state diagram of the preheating function by digital input:**

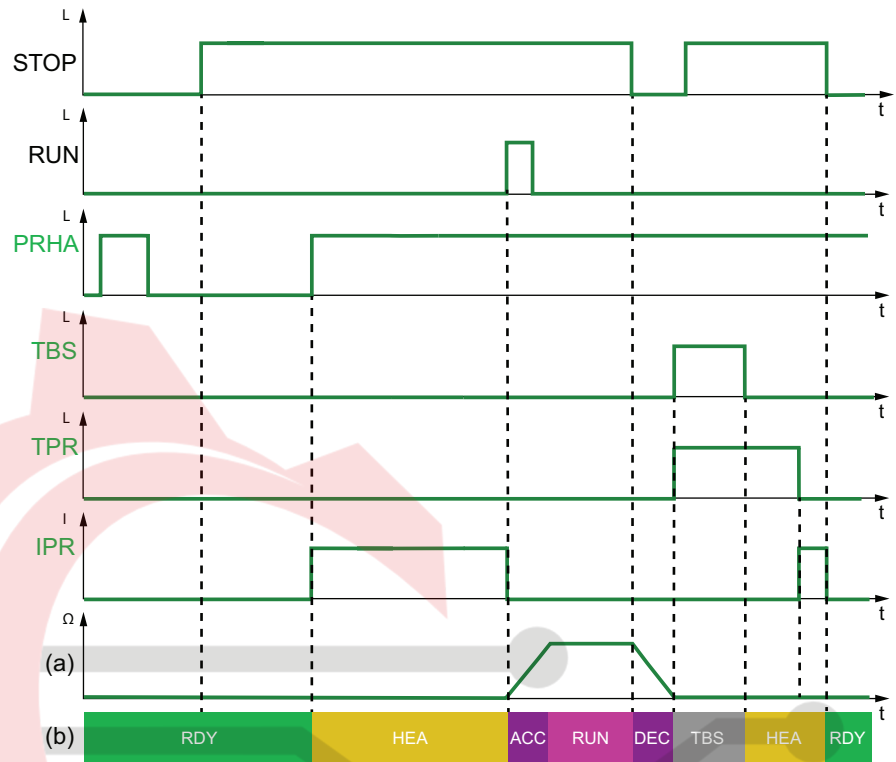

- **PRHA:** Level applied to the digital inputs assigned to **Preheating assignment**.
- **TBS:** **Time before motor restart**.
- **TPR:** **Time before preheat**.
- **IPR:** Preheat current injected in the motor.
- (a): Motor rotation speed
- (b): Soft starter state. For the list of possible state of the soft starter, refer to Soft Starter State, page 259.

**NOTE:** [Time Before Preheat] and [Time Before Restart] are not cumulative.

ماکان کنترول

## Parameters description

Access path: [Complete settings] → [Preheating]

Description	Setting range	Factory setting
[Preheating Assign] <i>PRHA</i>	-	[Not Assigned] <i>NO</i>

### Preheating assignment

Assign a digital or virtual input to start the preheating.

- **[Not Assigned]**: preheating start not assigned.
- **[DI3]**: preheating start assigned to digital input DI3.
- **[DI4]**: preheating start assigned to digital input DI4.
- **[Yes]**: preheating starts automatically without DI activation..
- **[CD●●]** : preheating start assigned to line channel.

**NOTE:** via virtual input the device needs to be in "operation enabled" state to be able to activate preheating.

It is possible to assign this parameter on a virtual input via the CMD word, bits 11 to 15. Refer to the fieldbus manuals for the CMD word assignments.

### ⚠ DANGER

#### ELECTRIC SHOCK AND/OR UNANTICIPATED EQUIPMENT OPERATION

- Verify that the setting of the parameter **[Time Before Preheat]** does not result in unsafe conditions.
- When preheating function is used, always consider that the equipment is in the operating state Operation Enabled.

**Failure to follow these instructions will result in death or serious injury.**

If the preheating is applied during the motor rotation, the preheating injection will maintain the rotation of the motor.

### ⚠ WARNING

#### LOSS OF CONTROL

- Verify that preheating operation is always starting when the motor is at standstill.
- If necessary, adjust the value of the parameter **[Time Before Preheat]** *TPR* to ensure the preheating operation will start at motor standstill.

**Failure to follow these instructions can result in death, serious injury, or equipment damage.**

ماکان کنترول

Description	Setting range	Factory setting
<b>[Preheat Level]</b> IPR	5...70% (% of the nominal motor current)	5%

**Preheating level**

This parameter sets the heating current level. Use a properly rated ammeter to adjust the preheating current level. This parameter has an impact on the current created by the minimum firing angle. During preheating, the motor thermal monitoring function is not active.

**NOTICE**

**MOTOR OVERHEATING**

- Verify that the connected motor is properly rated for the current to be applied in terms of amount and time.
- Add an external thermal sensor to monitor the temperature of the motor if preheating operation can result in motor windings overheating.

**Failure to follow these instructions can result in equipment damage.**

If the frequency of the mains is not stable, the preheating current level may be increased compared to the set value and lead to motor overheating.

**NOTICE**

**MOTOR OVERHEATING**

If the frequency of the mains is not stable:

- Add an external thermal sensor to monitor the temperature of the motor.
- or
- Add an external device to monitor the frequency and switch off the preheating function in case of fluctuations.

**Failure to follow these instructions can result in equipment damage.**

This parameter is visible only if **[Preheating Assign]** is set different from **[Not Assigned]**.

<b>[Time Before Preheat]</b> TPR	0...999 min	5 min
----------------------------------	-------------	-------

**Time before preheat**

The time delay set to this parameter starts as soon as the last Stop order is applied.

The soft starter will not preheat the motor as long as **[Time Before Preheat]** is not elapsed.

The status **[Motor Preheating]** HEA is displayed on the display terminal when the preheating order is applied.

**⚡⚠ DANGER**

**ELECTRIC SHOCK AND/OR UNANTICIPATED EQUIPMENT OPERATION**

- Verify that the setting of the parameter **[Time Before Preheat]** does not result in unsafe conditions.
- When preheating function is used, always consider that the equipment is in the operating state Operation Enabled.

**Failure to follow these instructions will result in death or serious injury.**

This parameter is visible only if **[Preheating Assign]** is set different from **[Not Assigned]**.

## Smoke Extraction

In rare cases, the monitoring functions of the device may be unwanted because they impede the purpose of the application. A typical example is a smoke extractor fan operating as a part of a fire protection system. If a fire occurs, the smoke extractor fan should operate as long as possible, even if, for example, the permissible ambient temperature of the device is exceeded. In such applications, damage to or destruction of the device may be acceptable as collateral damage, for example, to keep other damage from occurring whose hazard potential is assessed to be more severe.

A parameter is provided to disable certain monitoring functions in such applications so that automatic error detection and automatic error responses of the device are no longer active. You must implement alternative monitoring functions for disabled monitoring functions that allow operators and/or master control systems to adequately respond to conditions which correspond to detected errors. For example, if overtemperature monitoring of the device is disabled, the device of a smoke extractor fan may itself cause a fire if errors go undetected. An overtemperature condition can be, for example, signaled in a control room without the device being stopped immediately and automatically by its internal monitoring functions.

### ⚠ DANGER

#### MONITORING FUNCTIONS DISABLED, NO ERROR DETECTION

- Only use this parameter after a thorough risk assessment in compliance with all regulations and standards that apply to the device and to the application.
- Implement alternative monitoring functions for disabled monitoring functions that do not trigger automatic error responses of the device, but allow for adequate, equivalent responses by other means in compliance with all applicable regulations and standards as well as the risk assessment.
- Commission and test the system with the monitoring functions enabled.
- During commissioning, verify that the device and the system operate as intended by performing tests and simulations in a controlled environment under controlled conditions.

**Failure to follow these instructions will result in death or serious injury.**

This function can be used to disable the following monitoring functions:

- [No Power Comm Error]
- [Control Supply Error]
- [External Error]
- [Fieldbus Error]
- [Mains Freq Error]
- [FW Update Error]
- [Fware Pairing Err]
- [Internal Error 35]
- [Lock Rotor Error]
- [Overcurrent]
- [Device Overheat]
- [Process Overload]
- [Motor Overload]
- [Mains Sync Error]
- [Mains Direction Error]
- [Phase Loss]
- [Mains Loss]
- [Phase Inversion]
- [Mdb Com Interrupt]
- [PC Com Interrupt]
- [HMI Com Interruption]
- [Simu Mains Detected]
- [AI1 Th Sensor Error]
- [AI1 Th Level Error]
- [Too Long Start Err]
- [Proc Underload]
- [Supply Mains UnderV]

The warnings are still recorded in [Diagnostics] → [Diag. data] → [Last Warning].

**NOTE:** When this function is enabled, it is advised to add relevant warnings of inhibited error to a warning group to be able to monitor them more easily.

The Smoke Extraction function is not compatible with some functions. Refer to Functions Compatibility Table, page 151 for more information.

## Parameters description

Access path: **[Complete settings] → [Smoke Extraction]**

Description	Setting	Factory setting
<b>[Disable Error Detect]</b> <i>INH</i>	—	<b>[Not Assigned]</b> <i>NO</i>
<p><b>Disable error detection</b></p> <p>To disable error detection, this parameter can be set to:</p> <ul style="list-style-type: none"> <li>• <b>[Not Assigned]</b>.</li> <li>• <b>[DI3]</b>: Error inhibition when high level applied to terminal DI3</li> <li>• <b>[DI4]</b>: Error inhibition when high level applied to terminal DI4</li> <li>• <b>[CD••]</b>: Error inhibition assigned to line channel.</li> </ul> <p>It is possible to assign this parameter on a virtual input via the CMD word, bits 11 to 15. Refer to the fieldbus manuals for the CMD word assignments.</p> <p>Apply a high level to the assigned digital input to inhibit the error detection.</p>		
<p><b>⚠ WARNING</b></p>		
<p><b>UNANTICIPATED EQUIPMENT OPERATION</b></p> <p>Verify that permanently forcing the Run command via the digital input set to <b>[Disable Error Detect]</b> <i>INH</i>, does not result in unsafe conditions.</p> <p><b>Failure to follow these instructions can result in death, serious injury, or equipment damage.</b></p>		
<b>[Forced Run]</b> <i>INHS</i>	—	<b>[Disabled]</b> <i>NO</i>
<p><b>Forced Run</b></p> <p>This parameter can be set to:</p> <ul style="list-style-type: none"> <li>• <b>[Disabled]</b>: Not configured</li> <li>• <b>[Forced Run]</b>: Fault inhibition asks for a run order</li> </ul> <p><b>[Forced Run]</b> is forced to <b>[Disabled]</b> when <b>[Disable Error Detect]</b> is assigned on a virtual input.</p> <p>This parameter is visible only if <b>[Disable Error Detect]</b> is set to a digital input.</p>		

# Voltage Boost

This function can be used to provide a boost at the start to overcome a mechanical hard point.

As an application example, a chocolate crusher. The grinding of the chocolate is done when it's hot. Once the motor is stopped, the chocolate cools down, glueing the roller flatteners. In order to overcome the resistant torque due to the rollers being stuck by the chocolate and the elasticity of the material, it is necessary to apply a higher initial torque.

The voltage boost can be used in torque control and voltage control.

The voltage boost function apply a level of the nominal voltage **[Mains Voltage]** between 50% and 100% for 100 ms.

**[Init Starting Voltage]** is inhibited when **[Boost]** is active

Access path: **[Complete settings]** → **[Start & Stop]**

**Boost with torque control:**

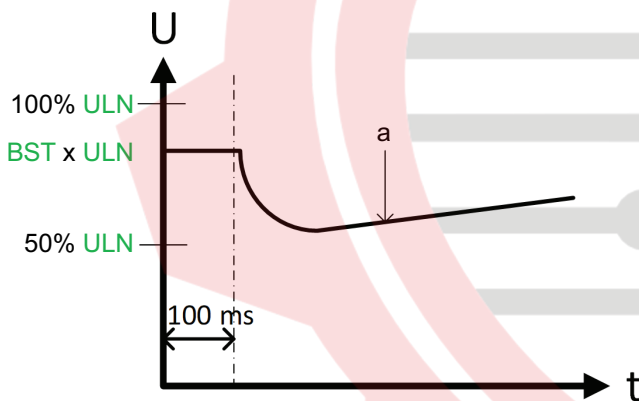

a: Voltage generated by the torque control

ULN: **Mains voltage**

BST: **Voltage boost level**

**Boost with voltage control:**

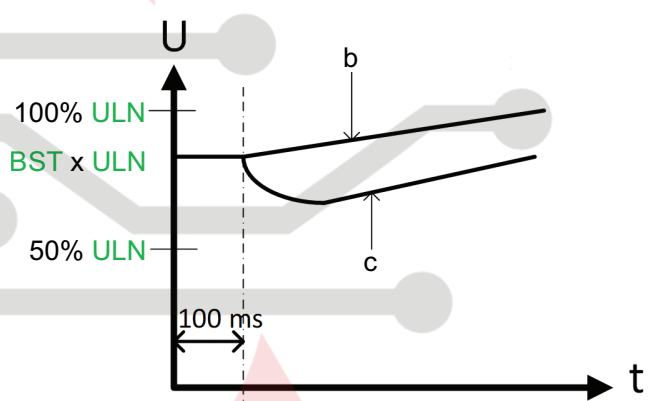

b: Voltage ramp initialized to **[Boost]** value

c: Voltage ramp in case of current limitation

ULN: **Mains voltage**

BST: **Voltage boost level**

Description	Setting range	Factory setting
<b>[Boost Assign]</b> <small>BSTE</small>		<b>[Not Assigned]</b> <small>NO</small>
<p><b>Boost assignment</b></p> <p>This parameter sets a digital input, or a virtual input via CMD word, (Refer to fieldbus manuals for the CMD word assignments), to activate the boost.</p> <ul style="list-style-type: none"> <li><b>[Not Assigned]:</b> Boost not assigned.</li> <li><b>[Yes]:</b> Boost will be activated on each motor start.</li> <li><b>[DI•]:</b> Boost assigned to digital input DI•.</li> <li><b>[CD••]:</b> Boost assigned to line channel.</li> </ul>		
<b>[Boost]</b> <small>BST</small>	50%...100% of <b>[Mains Voltage]</b> <small>ULN</small>	50%
<p><b>Voltage boost level</b></p> <p>Setting the value of this parameter too high can cause overcurrent and trigger error such as <b>[Overcurrent]</b>.</p>		

# Functions Compatibility Table

The choice of application functions can be limited by the incompatibility between certain functions. The functions that are not listed in the table below are not incompatible with any other functions.

	Functions <b>A</b> and <b>B</b> can be configured at the same time
X	The function <b>A</b> cannot be activated. Function <b>A</b> is incompatible with the function <b>B</b> .
D	Function <b>A</b> can be activated but deactivate the function <b>B</b> . Function <b>A</b> has priority.
	Not reachable.

Function B (already activated) →	[Phase Loss Monit]	[Small Motor Test]	[Preheating Assign]	[Mains Contactor]	[Torque Control]	[Gamma Sync Enable]
Function A (to be activated) ↓						
[Phase Loss Monit]		X (1)				
[Small Motor Test]	D(1)		D		D(2)	D(3)
[Preheating Assign]		X				
[Mains Contactor]						
[Torque Control]		X(2)				
[Gamma Sync Enable]		X(3)				

1. During small motor test, output phase loss is deactivated and its value configured before activation of small motor test is recovered, once small motor test is deactivated.
2. During small motor test, only voltage control is considered whatever configuration of **[Control Mode]** before activation of small motor test. **[Control Mode]** configuration before activation of small motor test is recovered once small motor test is deactivated.
3. During small motor test, **[Gamma Sync Enable]** is deactivated and its value configured before activation of small motor test is recovered once small motor test is deactivated.

Additionally, it is not possible to use:

- **[Forced Local]** function in **[Control Mode]** set to **[I/O profile]**.
- **[Device Lock]** sub-function without using **[Mains Contactor]** function.



# Command Channel

This chapter describes the way to command the soft starter using physical channels such as terminals, display terminal, fieldbus and others..

Access path: [Complete settings] → [Command channel]

## Configuration

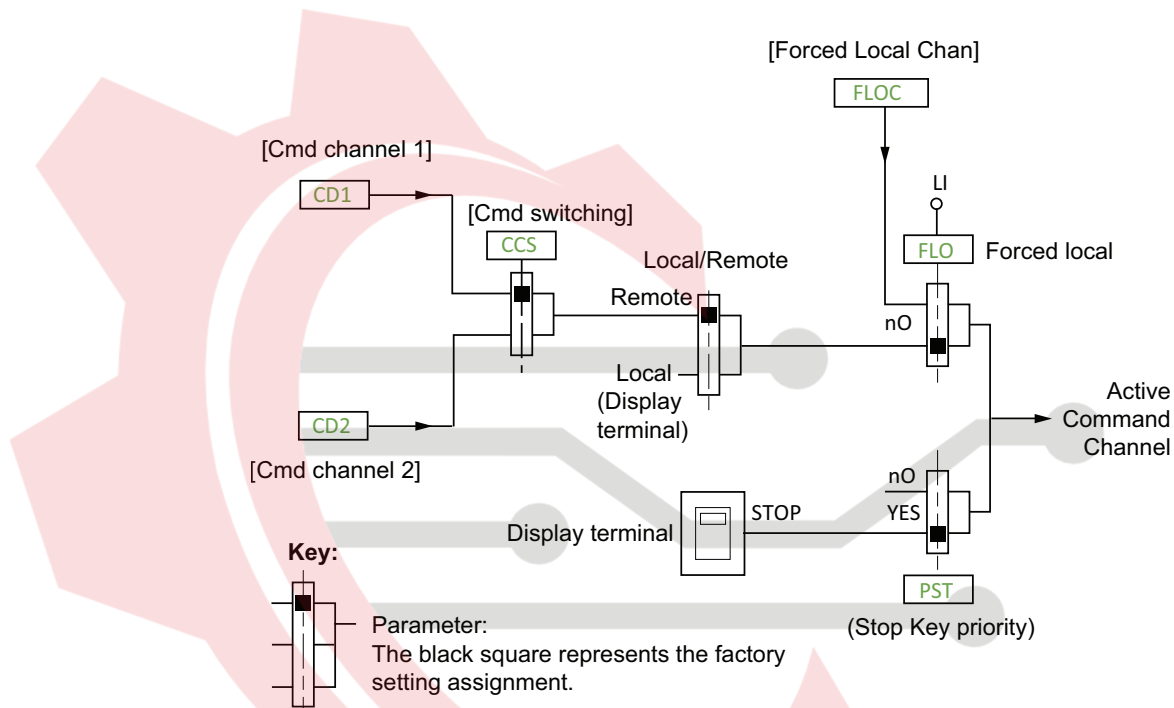

**NOTE:** If a **Stop command** is applied via a channel different from the active command channel, the motor can only be powered again by removing the active **Run command** and applying a new one.

**NOTE:** A function assigned to [CD●●] cannot be enabled/disabled when [HMI] is the **Active Command Channel**. Refer to fieldbus manual for more information.

HMI label	Setting	Factory setting
[Control Mode] CHCF	–	[Standard Profile] STD

### Control mode configuration

- Set [Control Mode] to [Standard Profile] to use the latest evolutions of the embedded Modbus. The [Standard Profile] is based on CIA402.
- Set [Control Mode] to [I/O profile] to mirror the use of the terminal, by allowing to use 1 bit of command register to activate a function.



## ⚠ WARNING

### UNANTICIPATED EQUIPMENT OPERATION



Disabling [I/O profile] IO resets the device to the factory settings.

- Verify that restoring the factory settings is compatible with the type of wiring used.

**Failure to follow these instructions can result in death, serious injury, or equipment damage.**

HMI label	Setting	Factory setting
[Command Switching]  CCS	–	[Cmd channel 1] CD1
<p><b>Command switching</b></p> <div style="border: 1px solid black; padding: 10px; text-align: center;"> <p><b>⚠ WARNING</b></p> <p><b>UNANTICIPATED EQUIPMENT OPERATION</b></p> <p>This parameter can cause unintended movements, for example, inversion of the direction of rotation of the motor, sudden acceleration or stops.</p> <ul style="list-style-type: none"> <li>• Verify that the setting of this parameter does not cause unintended movements.</li> <li>• Verify that the setting of this parameter does not result in unsafe conditions.</li> </ul> <p><b>Failure to follow these instructions can result in death, serious injury, or equipment damage.</b></p> </div> <p>This parameter sets which channel takes the command of the soft starter.</p> <ul style="list-style-type: none"> <li>• <b>[Cmd channel 1]</b> : Command channel defined via <b>Command channel 1 assign</b> (in this case, switching between <b>[Cmd channel 1]</b> and <b>[Cmd channel 2]</b> is not possible).</li> <li>• <b>[Cmd channel 2]</b> : Command channel defined via <b>Command channel 2 assign</b> (in this case, switching between <b>[Cmd channel 1]</b> and <b>[Cmd channel 2]</b> is not possible).</li> <li>• <b>[DI3]</b> : Command channel switching assigned to digital input DI3, this setting assign also <b>[DI3 assignment]</b> to <b>[Cmd switching]</b></li> <li>• <b>[DI4]</b> : Command channel switching assigned to digital input DI4, this setting assign also <b>[DI4 assignment]</b> to <b>[Cmd switching]</b></li> <li>• <b>[Cy••]</b> : Command channel switching assigned to line channel.</li> </ul> <p>When assigned to a digital input:</p> <ul style="list-style-type: none"> <li>• <b>[Cmd channel 1]</b> active at low level</li> <li>• <b>[Cmd channel 2]</b> active at high level</li> </ul>		
[Cmd channel 1] CD1	–	[Terminal] TER
<p><b>Command channel 1 assign</b></p> <p>This parameter sets the active command channel for <b>[Cmd channel 1]</b>.</p> <ul style="list-style-type: none"> <li>• <b>[Terminal]</b>: command with the digital inputs</li> <li>• <b>[HMI]</b>: command with the display terminal</li> <li>• <b>[Embd Mdb]</b>: command with the embedded Modbus</li> </ul>		
[Cmd channel 2]  CD2	–	[Embd Mdb] MDB
<p><b>Command channel 2 assign</b></p> <p>This parameter sets the active command channel for <b>[Cmd channel 2]</b>.</p> <ul style="list-style-type: none"> <li>• <b>[Terminal]</b>: command with the digital inputs</li> <li>• <b>[HMI]</b>: command with the display terminal</li> <li>• <b>[Embd Mdb]</b>: command with the embedded Modbus</li> </ul>		

HMI label	Setting	Factory setting
[Copy Ch1-Ch2]  COP	–	[No] NO
<p><b>Copy Ch.1-Ch.2</b></p> <p>This parameter copies the channel command configuration.</p> <ul style="list-style-type: none"> <li>• <b>[No]</b>: No copy.</li> <li>• <b>[Command]</b>: Copy the command words from channel 1 to channel 2 in <b>[Standard Profile]</b> and in both directions in <b>[I/O profile]</b>.</li> </ul> <p>When a remote display terminal is used and a communication interruption is detected with it, the embedded display terminal becomes active.</p> <p>If the transition to HMI command is done with the product in running state, and the parameter <b>[Copy Ch1-Ch2]</b> is set to <b>[Command]</b>, the product may continue in running state and the <b>STOP</b> button will only be accessible on the embedded display terminal.</p>		
<b>⚠ WARNING</b>		
<p><b>LOSS OF CONTROL</b></p> <p>Verify that in case of communication interruption with the remote display terminal, the <b>STOP</b> button of the embedded display terminal is easily accessible or that an integrated and functioning emergency stop push-button is within reach.</p> <p><b>Failure to follow these instructions can result in death, serious injury, or equipment damage.</b></p>		
<b>⚠ WARNING</b>		
<p><b>UNANTICIPATED EQUIPMENT OPERATION</b></p> <p>This parameter can cause unintended movements, for example, inversion of the direction of rotation of the motor, sudden acceleration or stops.</p> <ul style="list-style-type: none"> <li>• Verify that the setting of this parameter does not cause unintended movements.</li> <li>• Verify that the setting of this parameter does not result in unsafe conditions.</li> </ul> <p><b>Failure to follow these instructions can result in death, serious injury, or equipment damage.</b></p>		
<p><b>NOTE:</b> A command cannot be copied from a channel on terminals.</p>		

HMI label	Setting	Factory setting
<b>[Forced Local Assign]</b> 	—	<b>[Not Assigned]</b> NO
<p><b>Forced local assignment</b></p> <p>This parameter forces the local channel set by <b>[Forced Local Chan]</b>.</p> <p><b>[Forced Local Assign]</b> is active when a high level is applied to the set digital input. When the forced local channel is activated, the soft starter is stopped following the type of stop set by <b>[Type of stop]</b> if a Run command is not active on the forced channel and all the parameter write requests coming from fieldbus are rejected.</p> <p><b>NOTE:</b> <b>[Forced Local]</b> is not compatible with <b>[Control Mode]</b> set to <b>[I/O profile]</b>.</p> <p><b>[Forced Local Assign]</b> is active when a high level is applied to the set digital input.</p> <ul style="list-style-type: none"> <li><b>[Not Assigned]</b> : No digital input set</li> <li><b>[DI3]</b> : Forced local assignment set to digital input DI3 on high level, this setting assign also <b>[DI3 assignment]</b> to <b>[Forced Local]</b></li> <li><b>[DI4]</b> : Forced local assignment set to digital input DI4 on high level, this setting assign also <b>[DI4 assignment]</b> to <b>[Forced Local]</b></li> </ul> <p>The assigned digital input is set to <b>[Forced Local]</b>.</p>		
<b>[Forced Local Chan]</b> 	—	<b>[Terminal]</b> TER
<p><b>Forced Local channel assignment</b></p> <p>This parameter set which local channel is forced at the activation of the digital input set in <b>[Forced Local Chan]</b>.</p> <ul style="list-style-type: none"> <li><b>[Terminal]</b> : Forced local channel are the digital inputs</li> <li><b>[HMI]</b> : Forced local channel is forced on the display terminal</li> </ul> <p>This parameter is visible only if <b>[Forced Local Assign]</b> is configured. When a remote display terminal is used and a communication interruption is detected with it, the embedded display terminal becomes active.</p> <p>If the parameter <b>[Forced Local Chan]</b> is set to <b>[Terminal]</b> and the active command channel becomes the HMI at the exit of the forced local mode while the product is in running state, the product stays in this state and the <b>STOP</b> button will only be accessible on the embedded display terminal.</p>		
<b>⚠ WARNING</b>		
<p><b>LOSS OF CONTROL</b></p> <p>Verify that in case of communication interruption with the remote display terminal, the <b>STOP</b> button of the embedded display terminal is easily accessible or that an integrated and functioning emergency stop push-button is within reach</p> <p><b>Failure to follow these instructions can result in death, serious injury, or equipment damage.</b></p>		
<b>[Time-out forc. local]</b> 	0.1...30.0 s	10.0 s
<p><b>Time-out forc. local</b></p> <p>Timeout to confirm a new channel command after forced local deactivation.</p> <p>This parameter is visible only if <b>[Forced Local Assign]</b> is configured.</p> <p>At exit of forced local, in case of communication interruption, the active channel remains the forced channel until <b>[Time-out forc. local]</b> is expired. Without any new command coming from the channel command, the device will trigger <b>[Mdb Com Interrupt]</b> error.</p>		

# Input/Output Assignment

## What's in This Chapter

DI3 & DI4 Assignment.....	157
AI1 Configuration .....	158
AQ1 Configuration.....	159
R1 Configuration .....	161
R2 Configuration .....	162

This menu manages the assignments of the digital inputs, digital outputs, analog inputs, analog outputs and relays.

Digital inputs DI3 and DI4 assignments are active when a high level is applied, unless exceptions that are explicitly notified.

**NOTE:** For more information on how outputs behave when using communication, please refer to the related communication guides.

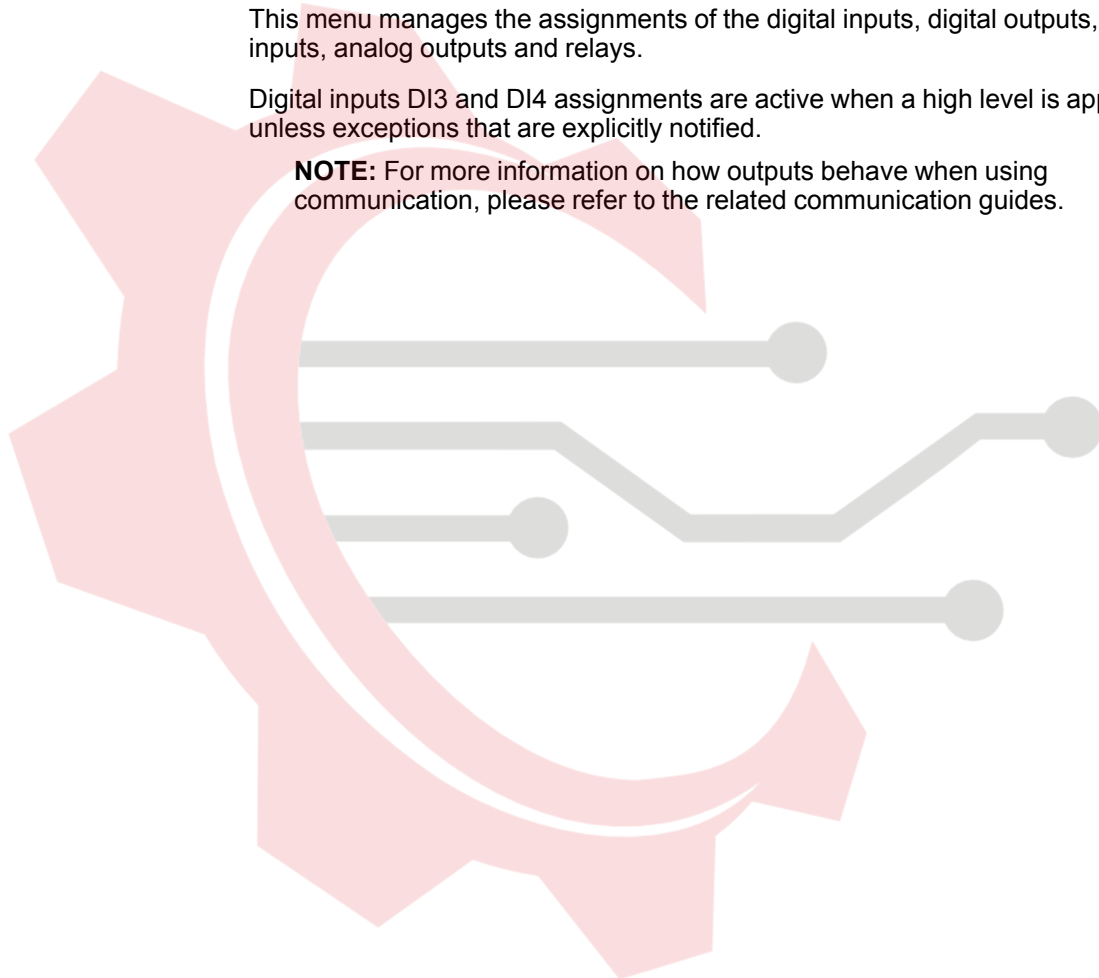

ماکان کنترول

## DI3 & DI4 Assignment

Those parameters provide the possible assignment to the digital inputs DI3 and DI4.

Access path: **[Input/Output]**

Description	Setting range	Factory setting
<b>[DI3 assignment]</b> L3A <b>[DI4 assignment]</b> L4A	-	<b>[No]</b> NO <b>[No]</b> NO
<p><b>DI3 assignment &amp; DI4 assignment</b></p> <p>Those parameters assign a function to the digital inputs DI3 and DI4.</p> <p>Only one function can be assigned to <b>[DI3 assignment]</b> or <b>[DI4 assignment]</b> at any moment. If you assign a new function to an already assigned digital input, the previous function assigned to this digital input will be deactivated.</p> <p>Unless specified otherwise, the following assignments are active when a high level is applied.</p> <ul style="list-style-type: none"> <li>• <b>[No]</b>: Digital input not assigned.</li> <li>• <b>[Fault Reset]</b>: Resets the device to clear a detected error after removing its cause.</li> <li>• <b>[External Error]</b>: Allows the device to trigger an external user error (level, pressure, ...). The external error can trigger on a high or low level, set by <b>[Ext Error Condition]</b>. Automatic assignment: <b>[Ext Error assign]</b> set to digital input.</li> <li>• <b>[Cmd switching]</b> : Sets the active command channel (<b>[Cmd channel 1]</b> active at low level or <b>[Cmd channel 2]</b> active at high level). This function can be assigned only via the parameter <b>[Command Switching]</b> in the menu <b>[Complete settings] → [Command channel]</b>. This function cannot be assigned via the menu <b>[Input/Output]</b>. If <b>[Command Switching]</b> is assigned to a digital input, it is necessary to remove first this assignation via the parameter before assigning the digital input to a new function.</li> <li>• <b>[Forced Local]</b>: Forces the local channel set by <b>[Forced Local Chan]</b>. Automatic assignment: <b>[Forced Local Assign]</b> set to digital input.</li> <li>• <b>[Disable Error Detect]</b>: Inhibits error detection. The soft starter records the detected errors but doesn't stop running. Automatic assignment: <b>[Disable Error Detect]</b> set to digital input.</li> <li>• <b>[Device Lock]</b>: Forces open the relay assigned to <b>[Mains Contactor]</b>. Active on low level. Automatic assignment: <b>[Device Lock]</b> set to digital input.</li> <li>• <b>[Preheating]</b>: Starts the preheating. Automatic assignment: <b>[Preheating Assign]</b> set to digital input.</li> <li>• <b>[Boost]</b>: Starts the preheating. Automatic assignment: <b>[Boost Assign]</b> set to digital input.</li> </ul>		

# AI1 Configuration



**[AI1 assignment]** provides the parameters to assign a thermal sensor to the analog input AI1/PTC1 and to set a filter on this input.

Access path: **[Input/Output] → [AI1 assignment]**

The following diagram explains how the analog input works:

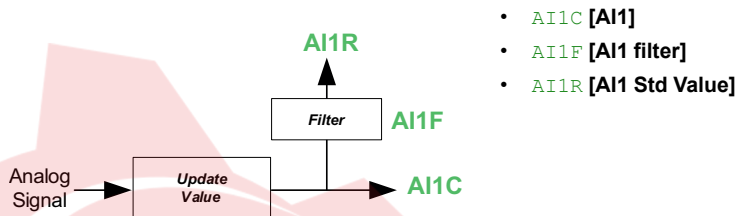

Description	Setting range	Factory setting
<b>[AI1 assignment]</b> <i>AI1A</i>	[No] or <b>[AI1 Th Monitoring]</b> <i>TH1S</i>	[No]
<p><b>AI1 assignment</b></p> <p>This parameter activates the thermal sensor monitoring on the terminal PTC1.</p> <ul style="list-style-type: none"> <li><b>[No]</b>: No function assigned to the terminal PTC1.</li> <li><b>[AI1 Th Monitoring]</b>: Thermal monitoring on PTC1 terminal assigned and active with a PTC thermal sensor and triggers an error on overheating detection. This allows to take the measured temperature on the motor into account for overheating detection.</li> </ul> <p><b>NOTE:</b></p> <p><b>[AI1 Th Monitoring]</b> cannot be assigned via <b>[AI1 assignment]</b> in the menu <b>[Input/Output]</b>. <b>[AI1 Th Monitoring]</b> can be assigned only via the parameter in the menu <b>[Monitoring]</b>.</p>		
<b>[AI1 Type]</b> <i>AI1T</i>	-	[Not Configured]
<p><b>Configuration of AI1</b></p> <p>This parameter sets the type of thermal sensors wired to PTC1/AI1.</p> <ul style="list-style-type: none"> <li><b>[PTC]</b>: 1 to 6 PTC in serial is used.</li> <li><b>[Not Configured]</b>: <b>Not Configured</b></li> </ul> <p><b>NOTE:</b> This parameter is accessible only if <b>[AI1 assignment]</b> is not set to <b>[No]</b>.</p>		
<b>[AI1 filter]</b> <i>AI1F</i>	0...10.00 s	0.00 s
<p><b>AI1 filter</b></p> <p>This parameter sets the cutoff time of the low filter for PTC1.</p> <p>The low pass filter aims to suppress electrical noise and avoid interference issue in the input signal.</p> <p>Accessible in the <b>[Monitoring]</b> menu.</p>		
<b>[AI1 Std Value]</b> <i>AI1R</i>	-	-
<p><b>Analog input 1 standardized value</b></p> <p>Real image of each AI consumed by functions is available via <b>[AI1 Std Value]</b> <i>AI1R</i>.</p> <p><b>NOTE:</b> this parameter is only accessible through the communication.</p> <p><b>NOTE:</b> if a thermal sensor is used, <b>[AI1 Th Value]</b> <i>TH1V</i> is linked to <i>AI1R</i>.</p>		

# AQ1 Configuration

This menu can be used to set the characteristics of the image of the signal sent by AQ1.

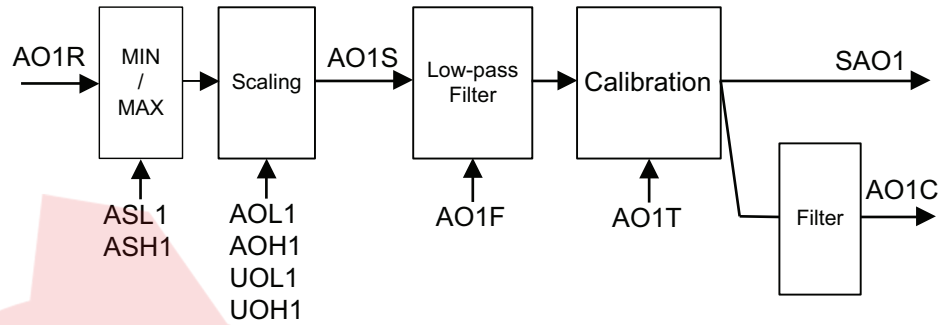

- AO1R [AO1 Std Value]
- ASL1 [Scaling AQ1 Min]
- ASH1 [Scaling AQ1 Max]
- AOL1 [AQ1 min output]
- AOH1 [AQ1 max output]
- UOL1 [AQ1 min Output]
- UOH1 [AQ1 max Output]
- AO1S [AQ1 Scaling]
- AO1F [AQ1 Filter]
- AO1T [AQ1 Type]
- SAO1 [AO1 Phy Val w/o Filter]
- AO1C [AQ1]

Access path: [Input/Output] → [AQ1 configuration]

Description	Setting range	Factory setting
[AQ1 assignment] AO1	–	[Motor Current] OCR
<b>AQ1 assignment</b> This parameter sets the characteristics of the image of the signal sent by AQ1. <ul style="list-style-type: none"> <li>• [Not Configured]: <i>Not configured.</i></li> <li>• [Motor Current]: <i>Motor current.</i></li> <li>• [Mot Mech Pwr %]: <i>Motor power in %.</i></li> <li>• [Mot Thermal]: <i>Motor thermal state.</i></li> <li>• [Power Factor]: <i>Power factor.</i></li> <li>• [Motor Torque]: <i>Motor torque.</i></li> <li>• [Reactive Power]: <i>Reactive Electrical input power.</i></li> </ul>		
[AQ1 Scaling] AO1S	50...700 %	200 %
<b>Analog output AQ1 scaling</b> This parameter sets the scaling of the maximum of AQ1 real image. If [AQ1 assignment] is set to [Power Factor] , [AQ1 Scaling] is forced to 100%. If [AQ1 assignment] is set to [Mot Thermal] , [AQ1 Scaling] is forced to 300%.		

Description	Setting range	Factory setting
[AQ1 Type] <b>AO1T</b>	[Voltage] 10U or [Current] 0A	[Current] 0A
<p><b>AQ1 Type</b></p> <p>This parameter sets the type of signal applied by AQ1.</p> <ul style="list-style-type: none"> <li>• [Voltage]: 0...10 Vdc.</li> <li>• [Current]: 0...20 mA.</li> </ul>		
[AQ1 min output] <b>AOL1</b>	0...20 mA	0 mA
[AQ1 min Output] <b>UOL1</b>	0...10 V	0 V
<p><b>AQ1 min output value and AQ1 minimum output</b></p> <p>This parameter sets the minimum value applied by AQ1.</p> <p><b>NOTE:</b> About <b>AOL1</b>, to comply with analog output 4...20 mA, set [AQ1 min output] to 4.</p> <p>[AQ1 min output] accessible only if [AQ1 Type] is set to [Current].</p> <p>[AQ1 min Output] accessible only if [AQ1 Type] is set to [Voltage].</p>		
[AQ1 max output] <b>AOH1</b>	0...20 mA	20 mA
[AQ1 max Output] <b>UOH1</b>	0...10 V	10 V
<p><b>AQ1 max output value and AQ1 maximum output</b></p> <p>This parameter sets the maximum value applied by AQ1.</p> <p>[AQ1 max output] accessible only if [AQ1 Type] is set to [Current].</p> <p>[AQ1 max Output] accessible only if [AQ1 Type] is set to [Voltage].</p>		
[Scaling AQ1 Min] <b>ASL1</b>	0...100 %	0 %
[Scaling AQ1 Max] <b>ASH1</b>		100 %
<p><b>Scaling AQ1 min and Scaling AQ1 max</b></p> <p>These parameters set the minimum and the maximum scaling of the signal applied by AQ1.</p> <ul style="list-style-type: none"> <li>• If [Scaling AQ1 Min] is superior to [Scaling AQ1 Max], [Scaling AQ1 Min] is forced equal to [Scaling AQ1 Max].</li> <li>• If [Scaling AQ1 Max] is inferior to [Scaling AQ1 Min], [Scaling AQ1 Max] is forced equal to [Scaling AQ1 Min].</li> </ul>		
		<ul style="list-style-type: none"> <li>• S: Scaling</li> <li>• R: Real image</li> <li>• (a): [Scaling AQ1 Max]</li> <li>• (b): [Scaling AQ1 Min]</li> </ul>
[AQ1 Filter] <b>AO1F</b>	0...10 s	0 s
<p><b>AQ1 filter</b></p> <p>This parameter sets the cutoff time of the low filter.</p> <p>The low pass filter aims to suppress electrical noise and avoid interference issue in the output signal.</p>		

## R1 Configuration

This menu provides the parameters to assign a function to the relay R1, to set its active level and holding time.

Access path: [Input/Output] → [R1 configuration]

Description	Setting range	Factory setting
[R1 Assignment] <i>R1</i>	—	[Operating State Fault] <i>FLT</i>
<p><b>R1 assignment</b></p> <p>This parameter assigns the condition for R1 to activate.</p> <ul style="list-style-type: none"> <li>• <b>[Not Assigned]:</b> Relay not assigned.</li> <li>• <b>[Operating State Fault]:</b> R1 is closed when the soft starter is supplied and no error is detected. R1 is opened when an error is detected or when the soft starter control supply A1/A2 is not present.</li> <li>• <b>[Mains Contactor]:</b> R1 manages the mains power supply by controlling the line contactor. R1 closed = Power supply applied to the power section of the soft starter.</li> </ul>		

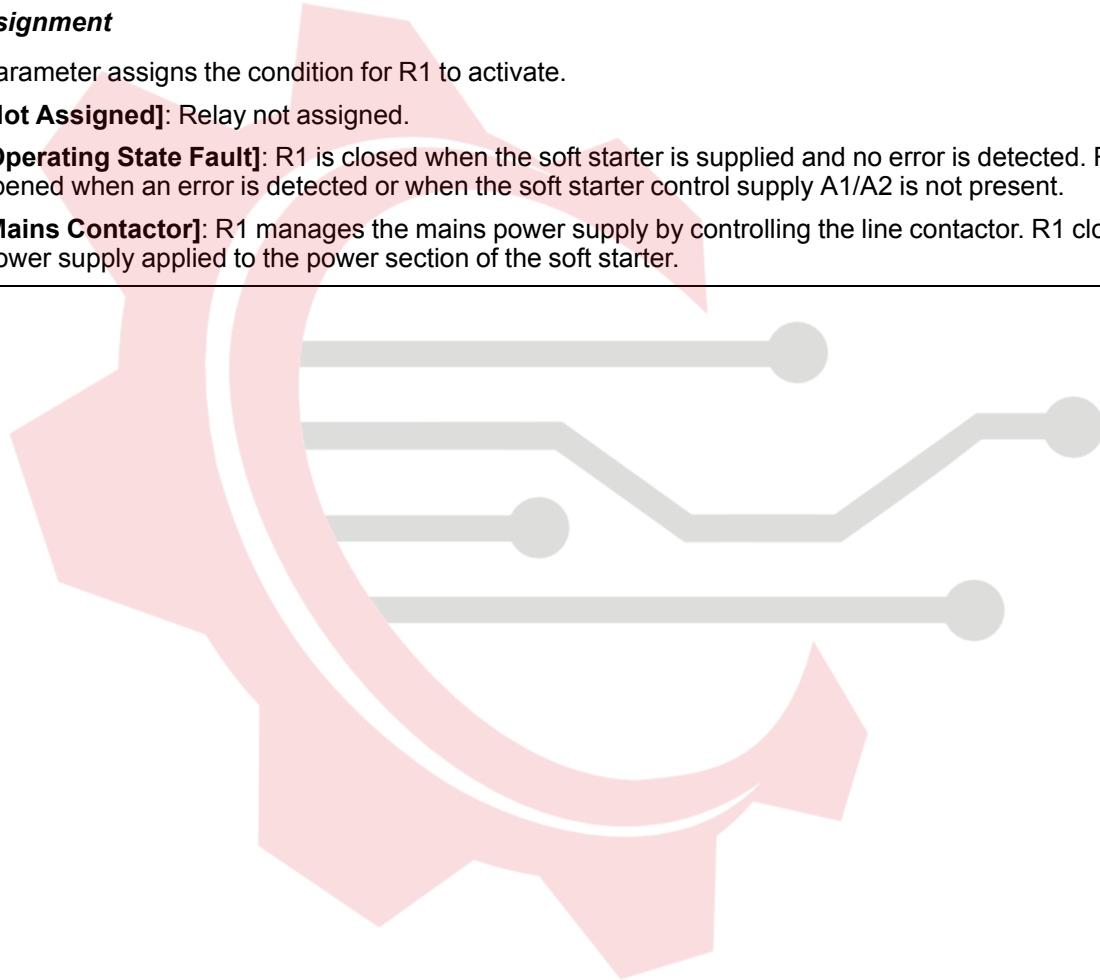



ماکان کنترول

## R2 Configuration

This menu provides the parameters to assign a function to the relay R2, to set its active level and holding time.

Access path: **[Input/Output]**

Description	Setting range	Factory setting
<b>[R2 Assignment]</b> R2	–	<b>[Not Assigned]</b> NO
<p><b>R2 assignment</b></p> <ul style="list-style-type: none"> <li>• <b>[Not Assigned]</b>: Relay R2 not assigned.</li> <li>• <b>[Operating State Fault]</b>: Activates R2 when the soft starter is supplied. Deactivates R2 when an error is detected. The motor stops in freewheel when an error is detected.</li> <li>• <b>[Mains Contactor]</b>: Activate R2 on a Run or Preheating order to close the mains contactor upstream the soft starter.</li> <li>• <b>[HMI L/R cmd]</b>: Control via the display terminal is active (only active with Local/Remote button).</li> <li>• <b>[Ready]</b>: Ready to start.</li> <li>• <b>[Device Running]</b>: <i>Device running</i>.</li> <li>• <b>[Per Type of Stop]</b>: Stop according to <b>[Type of stop]</b> parameter without triggering an error.</li> <li>• <b>[Warning Grp 1]</b>: <i>Warning group 1</i>.</li> <li>• <b>[Warning Grp 2]</b>: <i>Warning group 2</i>.</li> <li>• <b>[Warning Grp 3]</b>: <i>Warning group 3</i>.</li> <li>• <b>[Warning Grp 4]</b>: <i>Warning group 4</i>.</li> <li>• <b>[Warning Grp 5]</b>: <i>Warning group 5</i>.</li> <li>• <b>[Temp Sens AI1 Warn]</b>: Thermal sensor not operating correctly.</li> <li>• <b>[Device Th Warn]</b>: <i>Device thermal state warning</i>.</li> <li>• <b>[Ext Error Warn]</b>: <i>External error warning</i>.</li> <li>• <b>[UnderV Warn]</b>: <i>Undervoltage warning</i>.</li> <li>• <b>[Forced Run]</b>: <i>Forced Run</i>.</li> <li>• <b>[Inhibited Errors]</b>: The digital input set to <b>[Disable Error Detect]</b> is active.</li> <li>• <b>[Proc Undld Warn]</b>: <i>Process underload warning</i>.</li> <li>• <b>[Proc Overload Warn]</b>: <i>Process overload warning</i>.</li> <li>• <b>[Motor Overload Warn]</b>: <i>Motor overload warning</i>.</li> <li>• <b>[Dev Th reached]</b>: <i>Device thermal threshold reached</i>.</li> <li>• <b>[Mains Loss Warn]</b>: <i>Mains phase loss warning</i>.</li> <li>• <b>[Out Phase Loss]</b>: <i>Output phase loss warning</i>.</li> <li>• <b>[Overvoltage]</b>: <i>Overvoltage</i>.</li> <li>• <b>[Mains Unbalance]</b>: <i>Mains unbalance warning</i>.</li> <li>• <b>[Curr Unbal Warn]</b>: <i>Current unbalance warning</i>.</li> <li>• <b>[End Of Start]</b>: <i>End of start</i>.</li> </ul>		

Description	Setting range	Factory setting
 <b>[R2 Delay time]</b> R2D	0...60000 ms	0 ms
<p><b>R2 delay time</b></p> <p>This parameter sets the time delay for R2 after which the relay state will actually be activated.</p> <p><b>NOTE:</b> If [R2 Assignment] ( or [R3 Assignment]) is set to :</p> <ul style="list-style-type: none"> <li>• [End Of Start]</li> <li>• [Mains Contactor]</li> <li>• [Operating State Fault]</li> </ul> <p>R2 delay time is fixed on 0.</p>		
 <b>[R2 Active at]</b> R2S	<b>[High Level]</b> POS or <b>[Low Level]</b> NEG	<b>[High Level]</b> POS
<p><b>R2 active level</b></p> <p>This parameter sets the level applied by R2 when activated.</p> <ul style="list-style-type: none"> <li>• <b>[High Level]:</b> R2 applies a high level when activated.</li> <li>• <b>[Low Level]:</b> R2 applies a low level when deactivated.</li> </ul> <p><b>NOTE:</b> If [R2 Assignment] is set to :</p> <ul style="list-style-type: none"> <li>• [End Of Start]</li> <li>• [Mains Contactor]</li> <li>• [Operating State Fault]</li> </ul> <p>[R2 Active at] is fixed on <b>[High Level]</b>.</p>		
 <b>[R2 Holding time]</b> R2H	0...9999 ms	0 ms
<p><b>R2 holding time</b></p> <p>This parameter sets the holding time delay for R2 after which the relay state will actually be changed when a state change is ordered.</p> <p><b>NOTE:</b> If [R2 Assignment] is set to :</p> <ul style="list-style-type: none"> <li>• [End Of Start]</li> <li>• [Mains Contactor]</li> <li>• [Operating State Fault]</li> </ul> <p>R2 holding time is fixed on 0.</p>		

ماكان كنترول

# Configuration Files Management

## What's in This Part

Soft Starter Configuration files.....	165
Save & Restore a device configuration.....	166
Save & Restore a device image.....	167
Reset to Factory Settings.....	168
Product Restart.....	170
Soft starter firmware update.....	171
Display Terminal Language Update.....	174



ماکان کنترول

## Soft Starter Configuration files

In a soft starter, is called:

- A device configuration, a list of parameters settings in relation to the soft starter, the application, and the communication.
- A cybersecurity policy, containing all settings in relations with cybersecurity.
- A device image, regrouping the device configuration and cybersecurity policy.

Saving & Restoring Configuration, Backing up the device or doing a Factory settings will act differently on soft starter configuration files.



ماکان کنترول

## Save & Restore a device configuration

The device configuration can be saved on any Display Terminal. This function is used for cloning a soft starter or replacing a soft starter. The user has to ensure that the soft starter “source” and soft starter “destination” shall have the same product reference and the same topology (same firmware).

Saving & restoring acts only on the device configuration file.

Access path: **[Device Management] → [Save/Load]**

HMI label	Setting	Factory setting
<b>[Copy From Device]</b> SAF	–	–
This allows to store the actual soft starter configuration into the Display Terminal.		
Display Terminal	Number of configuration files store up	File name configurable
Plain text	1	No
Graphic	16	Yes
<b>[Copy To The Device]</b> OPF	–	–
This allows to select a device configuration previously stored in the Display Terminal and apply it to the soft starter. The device needs to be restarted after a configuration file transfer.		

Saving a device configuration can also be done by:

- connecting the soft starter to SoMove and by saving a \*.cfg file on your PC hard disk.
- connect the Graphic Display Terminal to the PC and transfer data by copy/paste.



ماکان کنترول

## Save & Restore a device image

The function is similar to Save and restore a device configuration, but it includes in addition the cybersecurity policy.

The device image can be saved on a Graphic Display Terminal (depending on the Graphic Display Terminal version).

Access path: **[Device Management]** → **[Save/Load]**

HMI label	Factory setting
<b>[Save backup image]</b> SBK 	–
This parameter can be used to save the actual product configuration and cybersecurity policy into the Display Terminal.	
Display Terminal	File name configurable
Plain text	No
Graphic	Yes
<b>[Load backup image]</b> OBK 	–
This parameter can be used to select a product configuration and cybersecurity policy configuration previously stored in the Display Terminal and apply it to the soft starter.	

Saving a device image can also be done by connecting the soft starter to SoMove and by saving a \*.bki file on your PC hard disk.

ماکان کنترول

# Reset to Factory Settings

## What's in This Chapter

Proceed with a Manufacturer Factory settings ..... 168  
 Proceed with a User-Defined Factory settings ..... 169

Access path: **[Device Management] → [Factory settings]**

Proceeding a factory settings aims to restore the original settings of the soft starter by erasing all modified parameters.

The soft starter offers 2 possibilities to restore the original settings:

- The Manufacturer Factory settings. Enabling this factory settings will copy the original configuration set defined by Schneider Electric, called "Macro Config" for which parameters will return to the default value. Default values can be overseen in the HMI navigation table, page 260.
- The User-defined Factory settings. The user will have the possibility to create his own original settings, select then apply them when doing a factory settings

For both factory settings:

- The function acts on the device configuration but does not erase logs and cybersecurity policy.
- The user can select all or partial device configuration to be restored.

## Proceed with a Manufacturer Factory settings

**NOTE:** This procedure acts on Device Configuration only, while Cybersecurity Policy stays untouched.

Step	Action
1	<p><b>Select partial or complete settings to be restored.</b></p> <p>In the <b>[Parameter group list] FRY</b> menu, select the parameter to restore to the factory settings in the following list:</p> <ul style="list-style-type: none"> <li>• <b>[All] ALL</b> : All parameters in all menus (except cybersecurity parameters).</li> <li>• <b>[Device Configuration] DRM</b>: Load <b>[Complete settings] CST</b> menu.</li> <li>• <b>[Comm. menu] COM</b> : Load embedded fieldbus menu.</li> <li>• <b>[Display config.] DIS</b> : Load display menu.</li> </ul>
2	<p><b>Ensure that the [Config. Source] is the Manufacturer one, means [Macro Config] is checked.</b></p>
3	<p>Go to <b>[Go to Factory Settings] GFS</b></p>
4	<p>The following safety message appears:</p> <div style="border: 1px solid black; padding: 10px; text-align: center;"> <p><b>⚠ WARNING</b></p> <p><b>UNANTICIPATED EQUIPMENT OPERATION</b></p> <ul style="list-style-type: none"> <li>• Verify that restoring the factory settings or modifying the configuration is compatible with the type of wiring used.</li> <li>• If you are recalling a stored configuration, perform a comprehensive commissioning test to verify correct operation.</li> </ul> <p><b>Failure to follow these instructions can result in death, serious injury, or equipment damage.</b></p> </div> <p>After reading this safety message, press <b>OK</b> (or <b>ESC</b> to exit).</p>
5	<p>The restoration is finished when the soft starter displays the previous menu.</p> <p>In factory configuration and after a return to "factory settings", <b>[Parameter group list] FRY</b> will be empty.</p>

## Proceed with a User-Defined Factory settings

Maximum three customer parameter sets can be saved on the soft starter.

**NOTE:** .The [Parameter group list] **FRY** parameter has an impact on the saved customer configuration.

**NOTE:** This procedure acts on Device Configuration only, while Cybersecurity Policy stays untouched.

### Save a configuration

Step	Action
1	In the [Save Configuration] <b>SCSI</b> menu, select: <ul style="list-style-type: none"> <li>• [Config 1] <b>STR1</b> to store the customer parameters set 1.</li> <li>• [Config 2] <b>STR2</b> to store the customer parameters set 2.</li> <li>• [Config 3] <b>STR3</b> to store the customer parameters set 3.</li> </ul>
2	To save, hold down the <b>OK</b> button until returned to the previous menu. The parameter changes back to [No] <b>NO</b> as soon as the operation is completed.

### Restore a configuration

Step	Action
3	In the [Config. Source] <b>FCSI</b> menu to recall a customer configuration, select device configuration previously saved in the following list: <ul style="list-style-type: none"> <li>• [Macro Config] <b>INI</b> for the factory settings parameters set.</li> <li>• [Config 1] <b>CFG1</b> for the customer parameters set 1.</li> <li>• [Config 2] <b>CFG2</b> for the customer parameters set 2.</li> <li>• [Config 3] <b>CFG3</b> for the customer parameters set 3.</li> </ul>
4	Press <b>OK</b> to select the customer parameters to recall.
5	<b>Select partial or complete settings to be restored.</b> In the [Parameter group list] <b>FRY</b> menu, select the parameter to restore to the factory settings in the following list: <ul style="list-style-type: none"> <li>• [All] <b>ALL</b> : All parameters in all menus (except cybersecurity parameters).</li> <li>• [Device Configuration] <b>DRM</b>: Load [Complete settings] <b>CST</b> menu.</li> <li>• [Comm. menu] <b>COM</b> : Load embedded fieldbus menu.</li> <li>• [Display config.] <b>DIS</b> : Load display menu.</li> </ul>
6	Go to [Go to Factory Settings] <b>GFS</b>
7	The following safety message appears: <div style="border: 1px solid black; padding: 10px; margin: 10px 0;"> <p style="text-align: center;"><b>⚠ WARNING</b></p> <p style="text-align: center;"><b>UNANTICIPATED EQUIPMENT OPERATION</b></p> <ul style="list-style-type: none"> <li>• Verify that restoring the factory settings or modifying the configuration is compatible with the type of wiring used.</li> <li>• If you are recalling a stored configuration, perform a comprehensive commissioning test to verify correct operation.</li> </ul> <p style="text-align: center;"><b>Failure to follow these instructions can result in death, serious injury, or equipment damage.</b></p> </div> <p>After reading this safety message, press <b>OK</b> (or <b>ESC</b> to exit).</p>
8	The restoration is finished when the soft starter displays the previous menu. In factory configuration and after a return to "factory settings", [Parameter group list] <b>FRY</b> will be empty.

# Product Restart

This function has the same effect as switch off/on the control supply A1/A2 of the soft starter.

Access path:

- [Complete settings] → [Error/Warn handling]
- [Communication] → [Modbus Fieldbus]
- [Diagnostics]

HMI label	Setting	Factory setting
[Product restart] <small>RP</small>	–	[No]
<p><b>Product restart</b></p> <p>Manually restarts the soft starter via the HMI. Press and hold the <b>OK</b> button on the display terminal for 2 seconds to restart the soft starter.</p> <p>This parameter is automatically set to <b>[Not Assigned]</b> after restart.</p> <ul style="list-style-type: none"> <li>• <b>[No]</b>: No restart</li> <li>• <b>[Yes]</b> : Restart the soft starter. After select <b>[Yes]</b>, this safety message is displayed:</li> </ul> <p>The Restart function performs a Fault Reset and then restarts the device. During this Restart procedure, the device goes through the same steps as if it had been switched off and on again. Depending on the wiring and the configuration of the device, this may result in immediate and unanticipated operation.</p> <div style="border: 1px solid black; padding: 5px; text-align: center;"> <p><b>⚠ WARNING</b></p> <p><b>UNANTICIPATED EQUIPMENT OPERATION</b></p> <p>The Restart function performs a Fault Reset and restarts the device.</p> <ul style="list-style-type: none"> <li>• Verify that activating this function does not result in unsafe conditions.</li> </ul> <p><b>Failure to follow these instructions can result in death, serious injury, or equipment damage.</b></p> </div> <p>Confirm the message and the soft starter will restart.</p>		

ماکان کنترول

# Soft starter firmware update

## Preparing soft starter for a firmware update

**NOTE:** Make sure that the latest version of the firmware and of the user manual are used.

**NOTE:** Make sure that the A1/A2 ports are supplied.

Install on your PC SoMove and the DTM.

To download the required DTM refer to ATS430: DTM, page 14.

To download SoMove go to SoMove FDT.

Connect the device to the PC. Use one of the following serial communication cables:

VW3A8127 for Modbus VP12S connection.

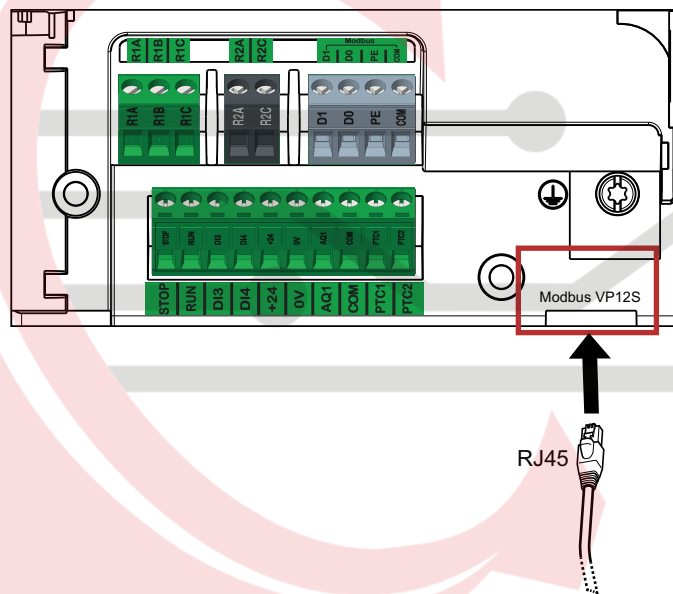

Download Altivar Soft Starter firmwares.

You can also request the soft starter to check if there is a firmware available.

Follow this Access path: **[Device Management] → [Firmware update]**

HMI label	Setting	Factory setting
<b>[Check For Update]</b> <small>NEW</small> 	—	—
This parameter is used to know if a new firmware version is available for the device or the plugged Plain Text Display Terminal. <b>NOTE: The update can take up to 30 minutes.</b>		

## Proceed a firmware update



The firmware is done in 3 steps:

Step	Actions
1	<p>Transfer: a firmware is transferred from the PC to the soft starter using the selected fieldbus.</p> <p>During this phase the soft starter remains operational.</p>
2	<p>Once the transfer is completed, the firmware package is accessible from <b>[Available Packages]</b> parameter.</p> <p>Follow this Access path: <b>[Device Management]</b> → <b>[Firmware update]</b></p> <p>This parameter is used to know all available firmware versions, new or legacy, for the device or the plugged Plain Text Display Terminal. It includes legacy, current and new firmware versions.</p> <p><b>NOTE: The update can take up to 20 minutes.</b></p> <p><b>NOTE: If the firmware update is not successful, do a power cycle before retrying the action.</b></p>
3	<p>Select one of available packages and apply it.</p> <div style="border: 1px solid black; padding: 10px; margin: 10px 0;"> <p style="text-align: center;"><b>⚠ WARNING</b></p> <p><b>UNANTICIPATED EQUIPMENT OPERATION</b></p> <p>Verify that the device is stopped (RDY or NST state). The device will not be operational until the firmware update procedure is completed.</p> <p>The relays, the analog and digital outputs may change state during the firmware update process. Depending on the wiring and the configuration of the device, this may result in immediate and unanticipated operation.</p> <p>Before applying the data previously transferred to the device or its option module:</p> <ul style="list-style-type: none"> <li>• Verify that the automation application controlling the device is stopped and that the device and its inputs and outputs, including communication channel(s) to external controller(s), cannot interact with your industrial process, and does not result in unsafe conditions.</li> <li>• Verify that the parameter <b>[Disable Error Detect]</b> <b>INH</b> is not assigned.</li> </ul> <p>In case of doubt, disconnect all analog and digital inputs and outputs of the device before applying the firmware update.</p> <p><b>Failure to follow these instructions can result in death, serious injury, or equipment damage.</b></p> </div> <p>During this phase, the soft starter is in a <b>[Firmware Update]</b> state. No operations are permitted.</p> <p>Depending on the software used, Transfer and Application can be:</p> <ul style="list-style-type: none"> <li>• Manual: the user confirms a transfer and confirms an application in front of the device using the display terminal or SoMove.</li> <li>• Automatic: the user confirms a transfer and apply, which means once the firmware is transferred, it is automatically applied to the soft starter</li> </ul>

## Soft starter Firmware information

The soft starter registers firmware information about the soft starter itself and the display terminal.

Information is displayed here:

HMI label	Setting	Factory setting
<b>[Version Info]</b>  VIF	–	–
<p>Follow this Access path: <b>[Device Management] → [Firmware update]</b></p> <p>This parameter gives the version of the packages applied at the latest firmware update.</p>		
<b>[Identification]</b>  OID	–	–
<p>Follow this Access path: <b>[Device Management] → [Identification]</b></p> <p>This parameter displays the identification numbers of the soft starter. This is a read-only menu that cannot be configured.</p> <p>It displays the following information:</p> <ul style="list-style-type: none"> <li>• Device name, if defined</li> <li>• Device reference</li> <li>• Current rating</li> <li>• Voltage rating</li> <li>• Device version</li> <li>• Firmware security state</li> <li>• Control version</li> <li>• Power version</li> <li>• Safety version</li> <li>• Device serial number</li> <li>• Display terminal identification, with name, version and serial number</li> </ul>		

ماکان کنترول

## Display Terminal Language Update

### Embedded and Plain Text Display Terminal Languages Update

For the Embedded and Plain Text Display Terminal (VW3A1113), the language package is included in the firmware package. It is transferred along with the firmware during the transfer part but not applied. The application is done manually.

The languages package can be selected in **[Device Management] → [Firmware update] → [Check For Update]**.

If a different language from the default list is required, a specific ATS firmware has to be released. Please contact Schneider Electric for a specific request.

### Graphic Display Terminal Languages Update



The Graphic Display Terminal (VW3A1111) language files can be updated.

Download the latest version of language files here: [Languages\\_Drives\\_VW3A1111](#)

The following table describes the procedure to update the language files of the Graphic Display Terminal:

Action	Step
1	Download the latest version of language files here: <a href="#">Languages_Drives_VW3A1111</a>
2	Save the downloaded file on your computer.
3	Unzip the file and follow the instructions of the ReadMe text file.

# Cybersecurity operating

## What's in This Part

Overview .....	176
Login .....	177
Logout .....	178
Account Management .....	179
Password .....	181
PIN Code .....	183
Admin Credentials Recovery .....	184
Upgrades Management .....	185
Save & Restore a Security Policy .....	186
Port Hardening .....	187
Security Functionality Verification .....	188
Clear Device / Secure Decommissioning .....	190

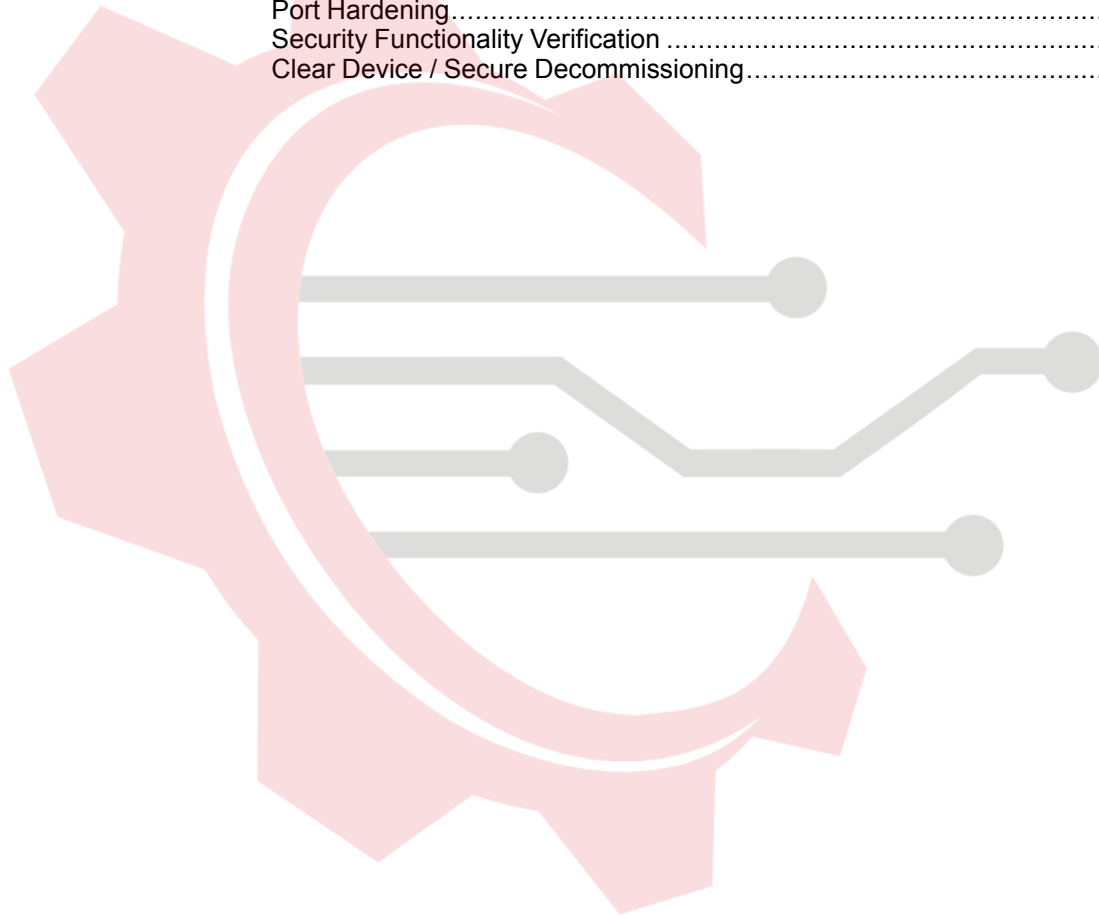

ماکان کنترول

## Overview

All the features listed in this chapter can be configured by using the . Refer to ATS430 DTM Online Help on SoMove for more information about the detailed settings available.

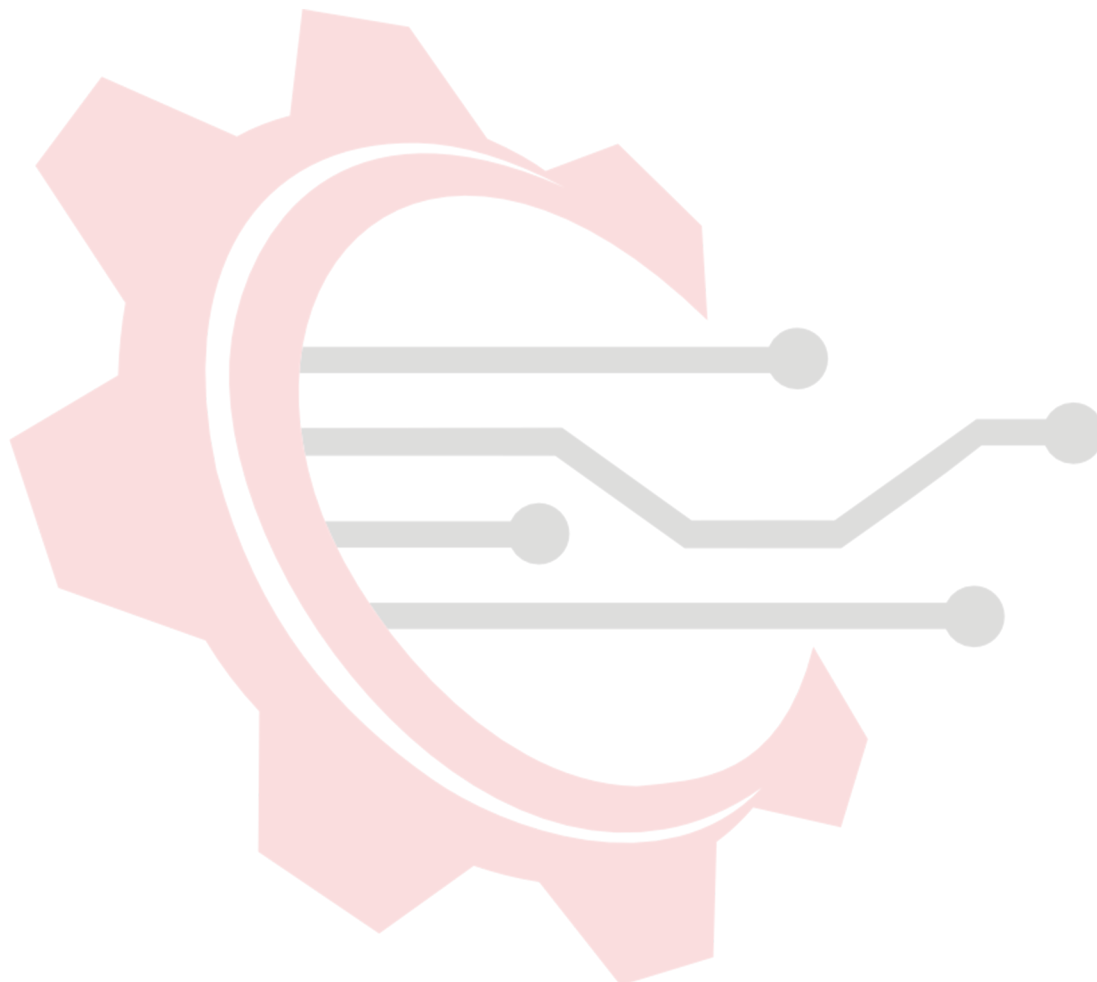

ماکان کنترول

## Login

The user access control can be configured by using the ATS430 DTM Admin tab on SoMove according to table below.

When enabled, the username and associated authentication factor will be requested.

Access	Authentication factor	Settings	Default setting
Graphic display terminal	User Pin code	ON/OFF	OFF
Commissioning tools	User password	ON/OFF — Modbus Serial	ON

## Brute Force Mitigation

Secure account policy defines the maximum wrong password attempts before locking the account during login on the different accesses. The secure account lockout settings are defined in table below and configurable with the ATS430 DTM Admin tab on SoMove. The secure account lockout settings can be set individually on each individual access from Commissioning tools

Parameter	Settings	Settings
<b>Max login attempts</b>	Disable or 1...99 wrong attempts	5
<b>Lock duration</b>	1...86400 seconds (24h)	240s
<b>Password attempt timer</b> (Time between 2 wrong attempts)	60...1800s (30min)	180s

**NOTE:** To unlock a temporarily locked user due to too many wrong attempts, either:

- Wait until the end of the lock duration time (240s as factory setting), or
- Restart the product, or
- An ADMIN or SecADMIN, manual locks and then manual unlocks the user.

## Security Banners

The security banners are warning messages displayed on login interface for system use notification.

The displayed message can be customized by authorized people in the DTM Admin options screen in the limit of 800 characters.

## Logout

### Manual Logout

For security reasons, it is recommended to logout after any operation on the ATS430.

- On the graphic display terminal, by pressing **ESC** and **HOME** Keys.
- On the ATS430 DTM on SoMove by disconnecting.

### Auto logout

Auto logout defines the maximum time the user is connected without activity before his session is automatically closed. The auto logout settings are defined in table below and configurable with the ATS430 DTM Admin tab on SoMove.

Parameter	Settings	Default setting
Timeout session	Disabled or 60...5940s	900s

The timeout is applied on the Graphic Display Terminal and commissioning tools connections. A setting defined for each channel.

The timeout is not applied when the DTM control panel is enabled

ماکان کنترول

# Account Management

## Administration Functions

The following administration functions are available for ADMIN and SecAdmin users in the ATS430 DTM Admin tab on SoMove:

- Create/Delete users
  - NOTE:** It is recommended to restart the product after deleting a user.
- Lock/Unlock users
  - NOTE:** Locked users can be Unlocked at any time. The assigned password, pin code and role are retained.
- Configure users
- Assign a role to users
- Assign/Reset/Request Change password and pincode
- Configure the password policy
- Configure session timeout on inactivity
  - NOTE:** The ATS430 is limited to 10 users per device.

When a user is created, a login policy is applied. This policy is not customizable. Here are the rules:

- All printable characters are allowed, except the following: " [ ] : ; | = + \* ? < > / \ , ' ,
- The period character "." is allowed, but can't be the final character
- Non-printable characters are not allowed. This includes all characters with ASCII code less than 32 in decimal. The delete control character, with ASCII code 127 in decimal is not allowed too.
- Identifier is not case sensitive. Username is stored in Upper case in the data base.
- Username size is between 4 and 32 characters.
- A username shall not have "NONE", "ADMIN", "ROOT", nor "VIEWER".
- The username must be unique and not related to your personal information.

## Roles and Rights

The ATS430 operations are protected by Role-Based Access Control (RBAC) concept. The roles are assigned with pre-defined rights. The users accounts are then created upon those roles with granted rights which are associated with the corresponding roles.

The following table provides an overview of the roles and their associated rights. The rights of the role cannot be changed from default.

Roles	Default account name (Non-case sensitive)	Rights
Engineer	Defined at user creation	Engineer can perform control actions, update device firmware, change settings, retrieve fault records and upload download the device configuration.
SecAdmin	Defined at user creation	In addition of Engineer rights, SecAdmin can change setting rules and backup retrieve the security configuration & device image.
Admin	ADMIN	In addition of SecAdmin rights, can perform a secure decommissioning of the device.

**NOTE:** ADMIN user is the system root user.

## Roles vs access rights

Rights	ADMIN	SecAdmin	Engineer
Configuration change	✓	✓	✓
Configuration read	✓	✓	✓
Configuration of factory settings	✓	✓	✓
Control	✓	✓	✓
Upload/Download device configuration	✓	✓	✓
Device monitoring	✓	✓	✓
Read security logs	✓	✓	
Read application logs	✓	✓	
Read error/warning logs	✓	✓	
Read device security settings	✓	✓	
Write device security settings	✓	✓	
Port hardening	✓	✓	
Create/Delete/Update/Lock users	✓	✓	
Export/Import security settings	✓	✓	
Backup/Restore device backup image	✓	✓	
Firmware update	✓	✓	✓
Firmware verify	✓	✓	✓
Secure decommissioning	✓		
ADMIN password reset	✓		

# Password

## Change Password

The individual user password can be changed from the DTM. See the ATS430 DTM Online Help on SoMove for more details.

## Reset Password

The Altivar Soft Starter ATS430 stores password in a secure non-reversible format. It is impossible to retrieve a password that has been lost by his user.

For ADMIN user, a special operation is available with the display terminal to reset the ADMIN password to a default value unique to the device.

To reset the ADMIN password:

Step	Action
1	Navigate to the menu <b>[Device Management] → [Cybersecurity]</b>
2	Scroll to the parameter <b>[Reset Password]</b> and press <b>OK</b>
3	The default password is visible on the display terminal in <b>[Default Password]</b> for the duration of 1min.

Upon first use, the commissioning tools will request the user to change this password prior to connecting. The cybersecurity policy does not change when the password is reset.

Other users shall rely on the ADMIN or SecAdmin users to request a reset of their individual password via the ATS430 DTM Admin options screen on SoMove.

## Password Policy

By default, the password policy of the Altivar Soft Starter ATS430 complies with IEEE 1686–2013 as following:

- 8 characters minimum with ASCII [32 to 122] characters
- At least one digit (0-9)
- At least one special character (@ % + ' ! # " \$ ^ ? : , ( ) [ ] ~ \_ . ; = & / \ - [SPACE])

In addition, for password changes, the password history is saved and prevents the reuse of a password that has been set at least once in the last 5 times by default.

The password policy can be customized or totally disabled to match with password policy defined in the system of which the device is part.

The following settings are available:

- Password policy: enabled/disabled. If disabled, a password is requested as authentication factor but there is no specific rule defined regarding the password robustness
- Password history: No restriction, Exclude last 3, Exclude last 5
- Special character required: YES/NO
- Numeric character required: YES/NO
- Alphabetic character required: YES/NO
- Minimum password length: any value between 6 and 20

This password policy customizing can only be done with the ATS430 DTM on SoMove. Please refer to ATS430 DTM Online Help on SoMove for more details.

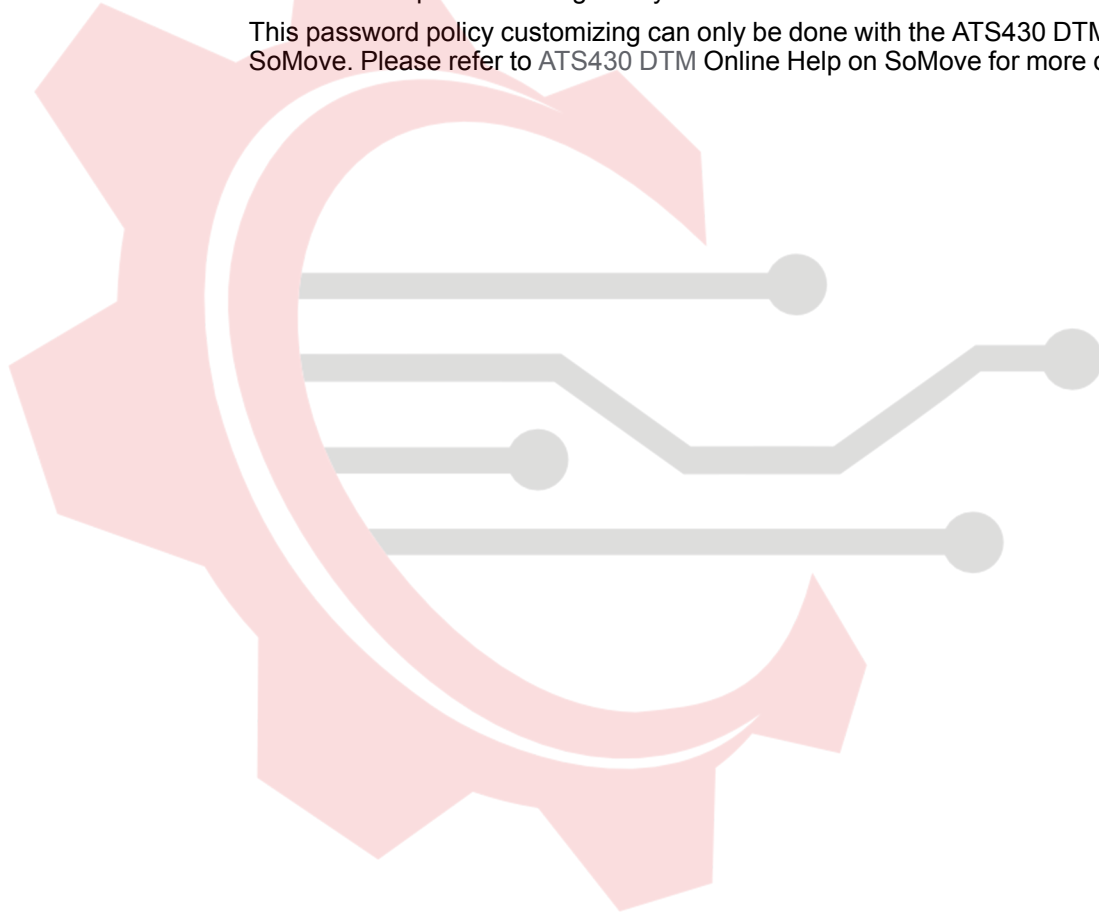

ماکان کنترول

## PIN Code

### PIN Code Access Activation

By default, the PIN code protection of the local Graphic terminal is not enabled. ADMIN or SecADMIN users can decide to activate this security feature with the ATS430 DTM Admin options screen on SoMove.

Once enabled, a login and PIN code will be requested to any user operating with the graphic display terminal. The pin code shall be set up with the ATS430 DTM Admin options screen on SoMove for each individual user. Users with no PIN code preset will not be able to operate with the Graphic display terminal

### Change PIN Code

The user PIN code can be changed from the ATS430 DTM Admin options screen on SoMove. Refer to for more details.

### Reset PIN Code

The Altivar Soft Starter ATS430 stores the PIN code in a secure non-reversible format. It is impossible to retrieve a PIN code that has been lost by its user.

Users can request on the ADMIN or SecADMIN users to change their individual PIN code via the ATS430 DTM Admin options screen on SoMove. See ATS430 DTM Online Help for more details.

ماکان کنترول

## Admin Credentials Recovery

In the situation, where the ADMIN user loses both the password and the PIN code, a special operation needs to be executed. The execution of this operation is limited to the ADMIN user only.

Please contact our Customer Care Center on: [www.se.com/CCC](http://www.se.com/CCC)



ماكان كنترول

## Upgrades Management

When the Altivar Soft Starter ATS430 firmware is upgraded, security configuration remains the same until changed, including usernames and passwords.

It is recommended that security configuration is reviewed after an upgrade to analyze rights for new or changed device features and revoke or apply them according to your company's policies and standards.



ماكان كنترول

## Save & Restore a Security Policy

The device cybersecurity policy can be saved on any Display Terminal. The user has to ensure that the soft starter “source” and soft starter “destination” shall have the same topology.

This menu provides the parameters to backup and restore the cybersecurity policy.

Access path: **[Device Management] → [Cybersecurity]**

HMI label	Setting	Factory setting
<b>[Save security policy]</b> SSE	–	–
This parameter can be used to save the actual cybersecurity policy into the Display Terminal.		
Display Terminal	Number of configuration files store up	File name configurable
Plain text	1	No
Graphic	16	Yes
<b>[Load security policy]</b> OSE	–	–
This parameter can be used to select a cybersecurity policy configuration previously stored in the Display Terminal and apply it to the soft starter.		

Managing a security policy can also be done by connecting the soft starter to the ATS430 DTM on SoMove and by saving/loading a \*.secp file on your PC.

ماکان کنترول

## Port Hardening

It is possible to disable a communication port or a specific protocol from ATS430 DTM Admin tab on SoMove with the ADMIN or SecADMIN rights.

The table below gives an overview of the physical ports that can be disabled :

Interface / Port	Settings	Default
Modbus Serial Ports		
RJ45/Network	ON / OFF <sup>(1)</sup>	ON

<sup>(1)</sup> RJ45/Network port is always available to keep local access for Graphic Display Terminal, commissioning access or ports and service configuration.

**NOTE:** A change in configuration of the ports above is considered after a power cycle.

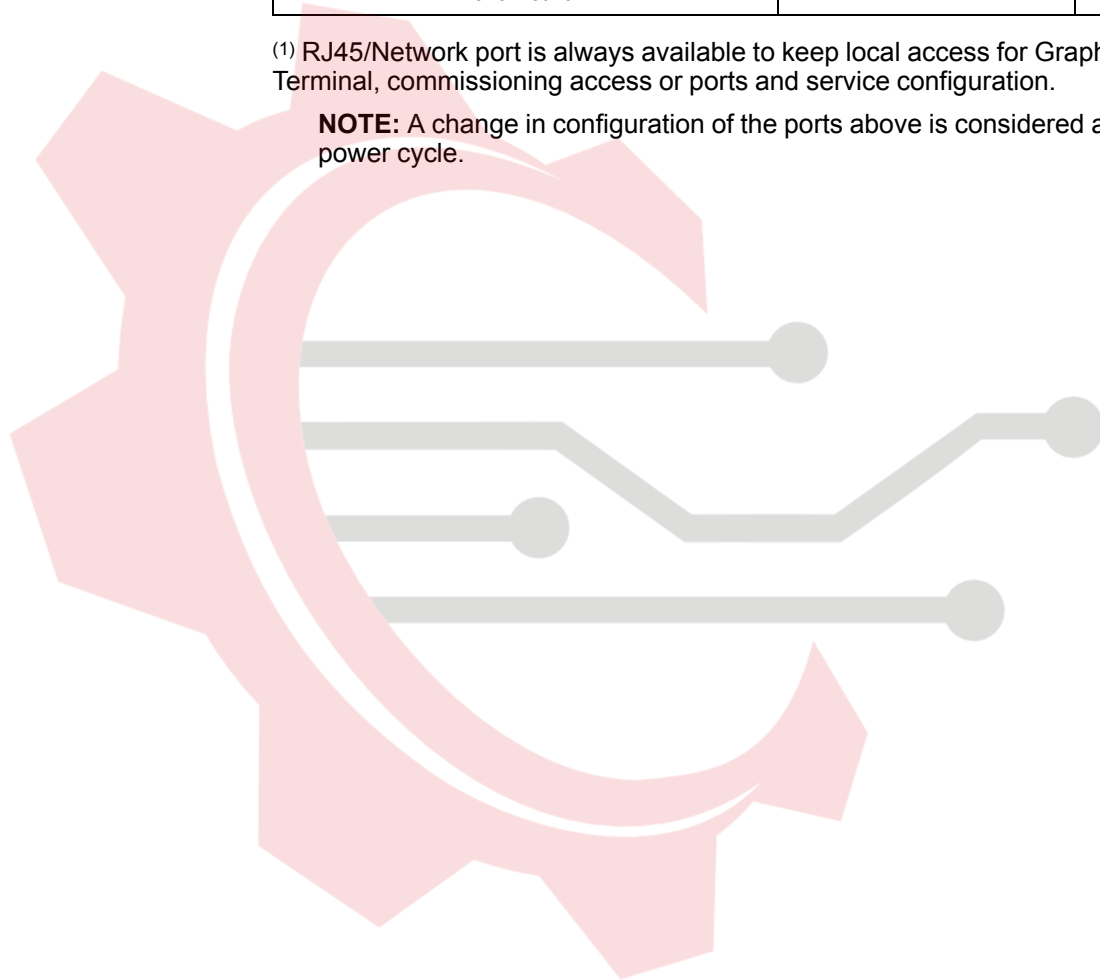

# ماکان کنترول

## Security Functionality Verification

When the cybersecurity policy and functionalities have been configured, it is strongly recommended to verify that the following functions are working as intended.

### Human User Access Control

The user access control can be individually tested on each interface of the ATS430. Please reproduce the following steps for each individual ATS430 interface:

Interface	Step	Action	✓
Commissioning tools connected on the Modbus Serial interface	1	Try to connect to the selected interface	
	2	Confirm the security banner is displayed prior authentication is requested	
		Confirm security banner message is in conformity with the message to be displayed for your organization.	
	3	Try to log in to ATS430 with no password or wrong password. <b>Result:</b> ATS430 does not give you access	
	4	Try to login with more than the MaxLoginAttempts (Default value : 5) with wrong password <b>Result:</b> The account is locked during Lock Duration (Default value 240s)	
Confirm the account is locked as well on other interfaces (SoMove (DTM))			
5	During this Lock Duration, connect another account with the right password. <b>Result:</b> SoMove (DTM) gives you access.		
Graphic Display Terminal access control (if enabled)	1	Try to log in to the Graphic Display Terminal with no PIN code or a wrong PIN code <b>Result:</b> Graphic Display Terminal does not give you access	
	2	Try to log in with more than the MaxLoginAttempts (Default value : 5) with wrong PIN code <b>Result:</b> The account is locked during Lock Duration (Default value : 240s)	
	3	During this Lock Duration, connect another account with the right password. <b>Result:</b> The Graphic Display Terminal gives you access.	

Confirm that access control is in conformity with the access control configuration requested for your installation.

### Password & PIN code Policy

Step	Action	✓
1	Connect to SoMove with your own account	
2	Try to modify your own password	
	Confirm that the password policy displayed is in conformity with the password policy expected for your installation.	
	Change your password, confirm that the selected password is accepted only if it's compliant with the password policy.	
3	Try to modify your own PIN code.	
	Confirm that the PIN code policy displayed is in conformity with the PIN code policy expected for your installation.	
	Change your PIN code, confirm that the selected PIN code is accepted only if compliant with the PIN code policy.	

## Timeout Session

Step	Action	✓
1	Connect to DTM or Graphic Display Terminal with right credentials	
2	Do nothing during the time defined in timeout tab for the specific channel. <b>Result:</b> The session is automatically disconnected	

## Audit

Step	Action	✓
1	After some or all the preceding tests, access the logging page of SoMove (ADMIN or SecADMIN account is requested)	
2	Download the log file	
3	Check that the user activity is correctly monitored in the system log files	

## Firmware Update

Step	Action	✓
1	Connect to SoMove	
2	Verify the version of each individual firmware version of the ATS430	
3	Confirm that the versions are as expected	
4	Try to perform a firmware update	
5	Select a random file	

## Disabling Communication Ports

Step	Action	✓
1	For each individual port disabled by configuration	
2	Confirm the ports are no longer usable No data flow detected as output and no data accepted as input	
4	For the port disabled by configuration, confirm the protocol refuses communication according to the column verification of chapter Port Hardening, page 187	

## Clear Device / Secure Decommissioning

The device security policy can be totally erased. This operation is part of the device secure disposal use case executed during clear device operation. This operation can be done by ADMIN user only.

Upon execution, security settings are totally erased from the device, including any internal backup, usernames, passwords, Ports and services, Brute force mitigation, Session timeout.

For security reasons, it is strongly recommended to perform this operation while removing the device from its intended environment.

To erase the device security policy go to one of those menu on the display terminal:

- **[Device Management] → scroll to [Clear device]**
- **[Device Management] → [Save/Load] and scroll to [Clear device]**

This parameter is visible in expert mode only. To active the expert mode go to the menu **[My preferences] → [Parameter access]** and set **[Access Level]** to **[Expert]**.

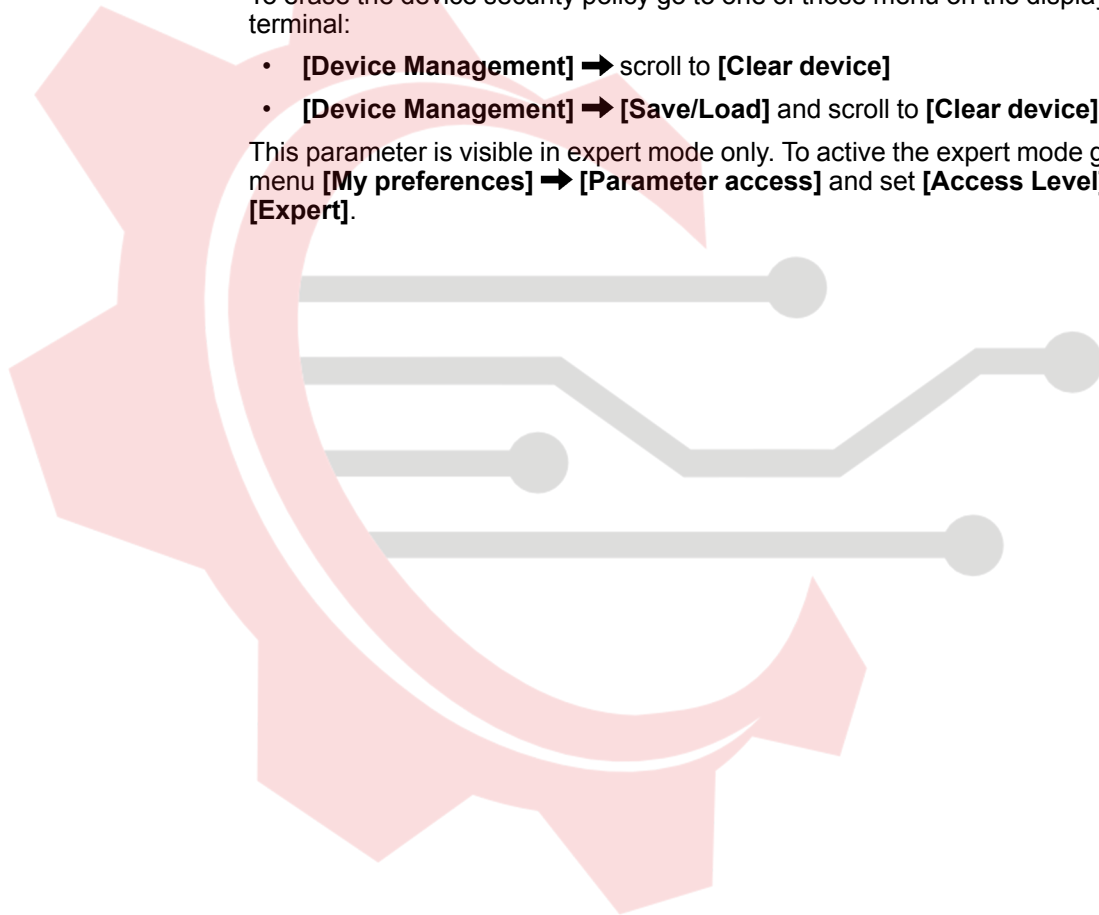

ماکان کنترول

# Communication

## What's in This Part

Modbus VP12S port configuration .....	192
Modbus Open Style Terminal .....	195
Modbus Network Diagnostics .....	196
Device Name .....	198



ماکان کنترول

## Modbus VP12S port configuration

Access path: **[Communication]**→ **[Modbus Fieldbus]**

The Modbus VP12S port can be used to configure the soft starter with SoMove DTM through Modbus RTU or to communicate a PLC.

The Modbus VP12S port can also be used to control the soft starter through Modbus RTU fieldbus. Please adjust Address, Baudrate, Format, Parity and Time out parameters. For controlling the soft starter via Modbus, refer to the Embedded Modbus RTU Manual for more information.

## Connection with a display terminal

To connect a display terminal to the Modbus RTU port, this configuration must be set:

- **[Modbus Baud Rate]** must be set to **[19200 bps]**.
- **[Term word order]** must be set to **[ON]**.
- **[Modbus Format]** must be set to **[8-E-1]**.

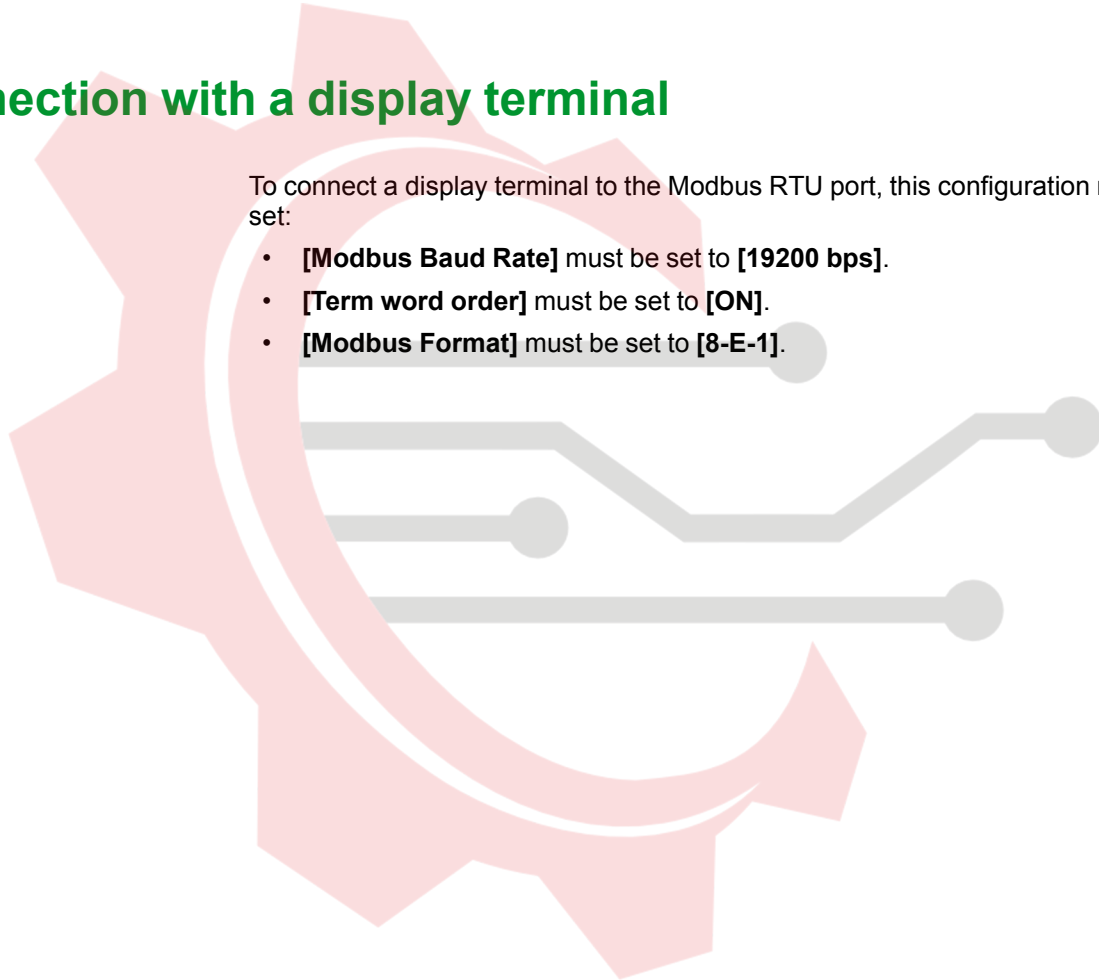

ماكان كنترول

## Modbus VP12S menu configuration

HMI label	Setting	
<b>[Modbus Address]</b> <small>ADD</small>	Logic address: 1771 hex = 6001 Range: 0...247 Factory setting: 0 (OFF)	Type: UINT (Unsigned16) Read/write: R/WS
<p><b>Device modbus address</b></p> <p>This parameter sets the embedded Modbus soft starter address. Address 0 is reserved for broadcast.</p>		
<b>[Modbus Baud Rate]</b> <small>TBR</small>	Logic address: 1773 hex = 6003 Factory setting: <b>[19200 bps]</b>	Type: WORD (Enumeration) Read/write: R/WS Unit: bps
<p><b>Modbus baud rate</b></p> <p>This parameter sets the embedded Modbus baud rate.</p> <ul style="list-style-type: none"> <li>• <b>[4800 bps]</b> : 4,800 bauds</li> <li>• <b>[9600 bps]</b> : 9,600 bauds</li> <li>• <b>[19200 bps]</b> : 19,200 bauds</li> <li>• <b>[38.4 Kbps]</b> : 38,400 bauds</li> </ul>		
<b>[Term word order]</b> <small>TWO</small>	Logic address: 1776 hex = 6006 Factory setting: <b>[ON]</b>	Type: WORD (Enumeration) Read/write: R/WS
<p><b>Terminal Modbus: Word order</b></p> <p>This parameter sets the embedded Modbus terminal word order.</p> <ul style="list-style-type: none"> <li>• <b>[OFF]</b> : Low word first</li> <li>• <b>[ON]</b> : High word first</li> </ul>		
<b>[Modbus Format]</b> <small>TFO</small>	Logic address: 1774 hex = 6004 Factory setting: <b>[8-E-1]</b>	Type: WORD (Enumeration) Read/write: R/WS
<p><b>Modbus format</b></p> <p>This parameter sets the embedded Modbus frame format.</p> <p><b>NOTE:</b> Connection to SoMove is done using the format <b>[8-E-1]</b> .</p> <ul style="list-style-type: none"> <li>• <b>[8-O-1]</b> : 8 bits odd parity 1 stop bit</li> <li>• <b>[8-E-1]</b> : 8 bits even parity 1 stop bit</li> <li>• <b>[8-N-1]</b> : 8 bits no parity 1 stop bit</li> <li>• <b>[8-N-2]</b> : 8 bits no parity 2 stop bits</li> </ul>		

HMI label	Setting	
[Modbus Timeout] <b>TTO</b>	Logic address: 1775 hex = 6005 Range: 0.1...30 s Factory setting: 5 s	Type: UINT (Unsigned16) Read/write: R/WS Unit: 0.1 s
<b>Modbus timeout</b>		
This parameter sets the embedded Modbus communication timeout. <b>NOTE:</b> For information, the communication timeout with the display terminal is 2 seconds and cannot be modified.		
[Modbus Error Resp] <b>SLL</b>	Logic address: 1B62 hex = 7010 Factory setting: <b>[Freewheel Stop]</b>	Type: WORD (Enumeration) Read/write: R/WS
<b>Response to Modbus interruption</b>		
This parameter sets the type of stop applied to the motor when a loss of communication is detected on the Modbus channel for both ports.		
<ul style="list-style-type: none"> <li>• <b>[Ignore]</b>: Trigger <b>[Modbus Com Warn] SLLA</b>. The warning should be assigned to a warning group in <b>[Warn groups config]</b> to be visible when triggered. Refer to <i>Warning Messages</i>, page 226.</li> <li>• <b>[Freewheel Stop]</b>: Error <b>[Mdb Com Interrupt] SLF1</b> is triggered and motor stops in freewheel.</li> <li>• <b>[Configured Stop]</b>: Motor stops according to the value set in <b>[Type of stop]</b>, <b>[Modbus Com Warn] SLLA</b> is triggered.</li> <li>• <b>[Deceleration]</b>: Motor stops in deceleration and an error <b>[Mdb Com Interrupt] SLF1</b> is triggered at the end of deceleration.</li> </ul>		
<b>⚠ WARNING</b>		
<b>LOSS OF CONTROL</b>		
If this parameter is set to <b>[Ignore]</b> , Modbus communication monitoring is disabled.		
<ul style="list-style-type: none"> <li>• Only use this setting after a thorough risk assessment in compliance with all regulations and standards that apply to the device and to the application.</li> <li>• Only use this setting for tests during commissioning.</li> <li>• Verify that communication monitoring has been re-enabled before completing the commissioning procedure and performing the final commissioning test.</li> </ul>		
<b>Failure to follow these instructions can result in death, serious injury, or equipment damage.</b>		
[Product restart] <b>RP</b>	–	[Not Assigned] <b>NO</b>
<b>Product restart</b>		
For more information, refer to <i>Product Restart</i> , page 170.		

# Modbus Open Style Terminal

This menu provides the parameters to manage the communication with the open style terminal.

Access path: **[Communication]**

HMI label	Setting	
<b>[Modbus 3 baud rate]</b> TBR3	Logic address: 1799 hex = 6041 Factory setting: <b>[19200 bps]</b>	Type: WORD (BitString16) Read/write: R/WS Unit: bps
<p><b>Modbus 3 baud rate</b></p> <p>This parameter sets the baud rate of the Open Style Terminal port.</p> <ul style="list-style-type: none"> <li><b>[4800 bps]</b> : 4,800 bauds</li> <li><b>[9600 bps]</b> : 9,600 bauds</li> <li><b>[19200 bps]</b> : 19,200 bauds</li> <li><b>[38.4 Kbps]</b> : 38,400 bauds</li> </ul>		
 <b>[Term 3 word order]</b> TWO3	Logic address: 17A4 hex = 6052 Factory setting: <b>[ON]</b>	Type: WORD (BitString16) Read/write: R/WS
<p><b>Terminal Modbus 3: Word order</b></p> <p>This parameter sets the terminal of the Open Style Terminal port word order.</p> <ul style="list-style-type: none"> <li><b>[OFF]</b> : Low word first</li> <li><b>[ON]</b> : High word first</li> </ul>		
<b>[Modbus 3 format]</b> TFO3	Logic address: 179A hex = 6042 Factory setting: <b>[8-E-1]</b>	Type: WORD (BitString16) Read/write: R/WS
<p><b>Modbus 3 format</b></p> <p>This parameter sets the frame format of the Open Style Terminal port.</p> <ul style="list-style-type: none"> <li><b>[8-O-1]</b> : 8 bits odd parity 1 stop bit</li> <li><b>[8-E-1]</b> : 8 bits even parity 1 stop bit</li> <li><b>[8-N-1]</b> : 8 bits no parity 1 stop bit</li> <li><b>[8-N-2]</b> : 8 bits no parity 2 stop bits</li> </ul>		



# Modbus Network Diagnostics

Used for the Modbus serial communication port at the bottom of the control block.

Access path: **[Communication]**

## [Modbus network diag] menu

HMI label	Setting	Factory setting
<b>[COM LED]</b> <small>MDB1</small>	–	–
<b>COM LED</b> View of the Modbus communication LED.		
<b>[Mdb Frame Nb]</b> <small>M1CT</small>	Logic address: 177B hex = 6011 Range: 0...65535	Type: UINT (Unsigned16) Read/write: R Unit: -
<b>Mdb frame number</b> Indicate the number of Modbus frames send or received. The counter counts both correct and incorrect frames. <b>Mdb frame number</b> is modulo 65 536 counters, this means that, the value is reset to zero once the value of 65 535 is reached.		
<b>[Mdb CRC errors]</b> <small>M1EC</small>	Logic address: 177A hex = 6010 Range: 0...65535	Type: UINT (Unsigned16) Read/write: R
<b>Mdb CRC errors</b> Indicate the number of Modbus frames containing checksum errors. By contrast of <b>[Mdb Frame Nb]</b> , the <b>[Mdb CRC errors]</b> remain at 65 535 once this value is reached.		
<b>[Mdb com stat]</b> <small>COM1</small>	Logic address: FA2F hex= 64047	Type: WORD (Enumeration) Read/write: R
<b>Modbus com. status</b> Modbus communication status. <ul style="list-style-type: none"> <li>• <b>[R0T0]</b> : Modbus no reception, no transmission</li> <li>• <b>[R0T1]</b> : Modbus no reception, transmission</li> <li>• <b>[R1T0]</b> : Modbus reception, no transmission</li> <li>• <b>[R1T1]</b> : Modbus reception and transmission</li> </ul>		

In the case of these two counters (**[Mdb CRC errors]** and **[Mdb Frame Nb]**), only frames that are destined for the device and whose Modbus address is supplied by the **[Modbus Address]** parameter are counted. Broadcast frames are not counted.

## [Modbus Term Diag] menu

Used for the Open Style communication port:

Access path **[Communication]** – → **[Modbus Term Diag]**

HMI label	Setting	Factory setting
<b>[COM LED]</b> <small>MDB3</small>	–	–
<b>COM LED</b> View of the Modbus communication LED.		
<b>[Mdb Term frames]</b> <small>M3CT</small>	Logic address: 179D hex = 6045 Range: 0...65535	Type: UINT (Unsigned16) Read/write: R
<b>Mdb TERM frames</b> Terminal Modbus 3: number of processed frames.		
<b>[Mdb Term CRC errors]</b> <small>M3EC</small>	Logic address: 179C hex = 6044 Range: 0...65535	Type: UINT (Unsigned16) Read/write: R
<b>Mdb TERM CRC errors</b> Terminal Modbus 3: number of CRC errors.		
<b>[Mdb com stat]</b> <small>COM3</small>	Logic address: FA5C hex = 64092	Type: WORD (Enumeration) Read/write: R
<b>Modbus communication status</b> Modbus port 3 activity display: <ul style="list-style-type: none"> <li>• <b>[R0T0]</b> : Modbus no reception, no transmission</li> <li>• <b>[R0T1]</b> : Modbus no reception, transmission</li> <li>• <b>[R1T0]</b> : Modbus reception, no transmission</li> <li>• <b>[R1T1]</b> : Modbus reception and transmission</li> </ul>		

ماکان کنترول

## Device Name

This menu provides the parameter to edit the **[Device Name]**.

Access path: **[Device Management]** → **[Device Name]**

HMI label	Setting	Factory setting
<b>[Device Name]</b> PAN	–	–
In the case of this device, this is represented by the <b>[Device Name]</b> parameter. Check that all the network devices have different “Device Names”.		

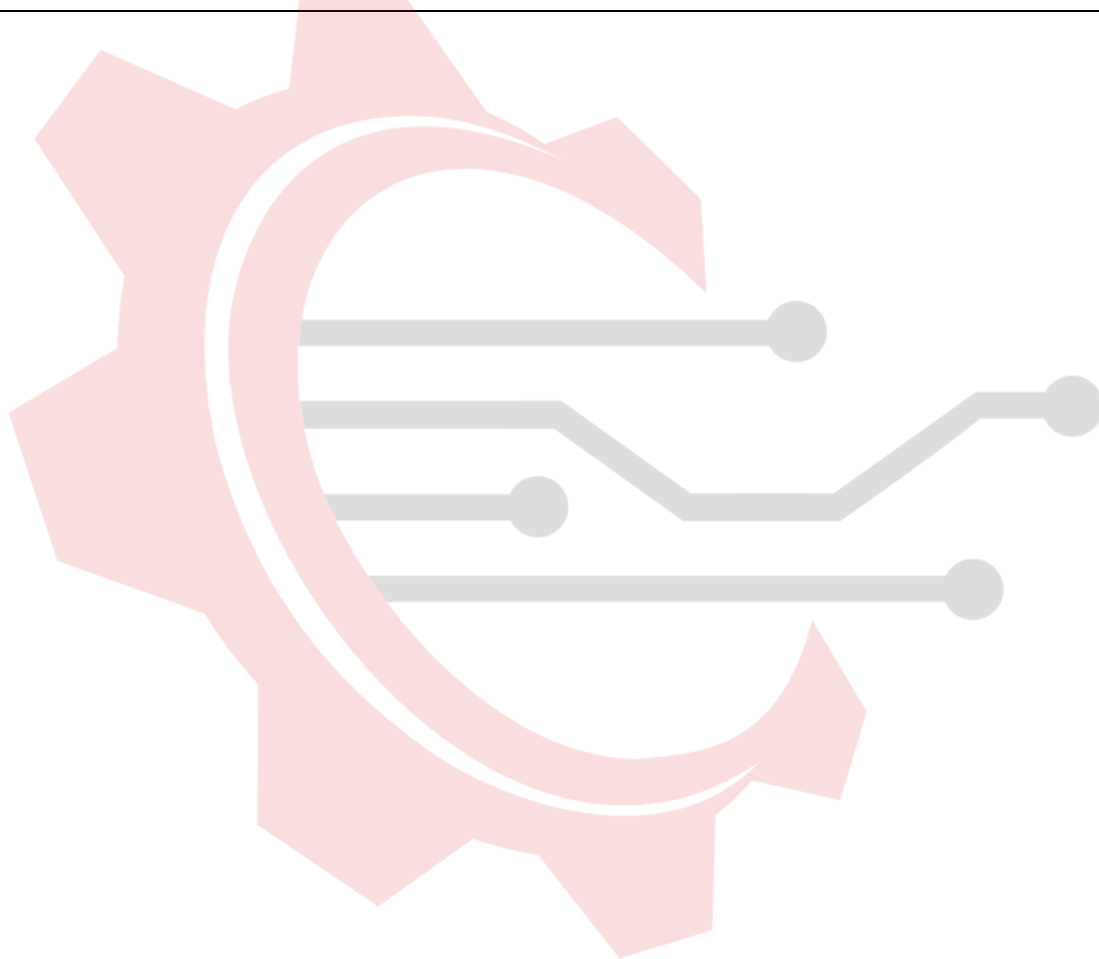

ماکان کنترول

## Monitor the displayed values

### What's in This Part

Monitor current measurements .....	200
Monitor voltage measurements .....	201
Monitor power measurements .....	202
Monitor other measurements .....	203
Monitor thermal measurements .....	204
Counter Management .....	205
Other States .....	206
Input & Output Map .....	207
Energy parameters .....	208

This menu provides the parameters to monitor the key physical values of the motor, the soft starter and the application such as:

- Motor electrical and torque values
- Device and motor thermal state
- Device and motor run time
- State of the device
- Inputs/Outputs status and assignment

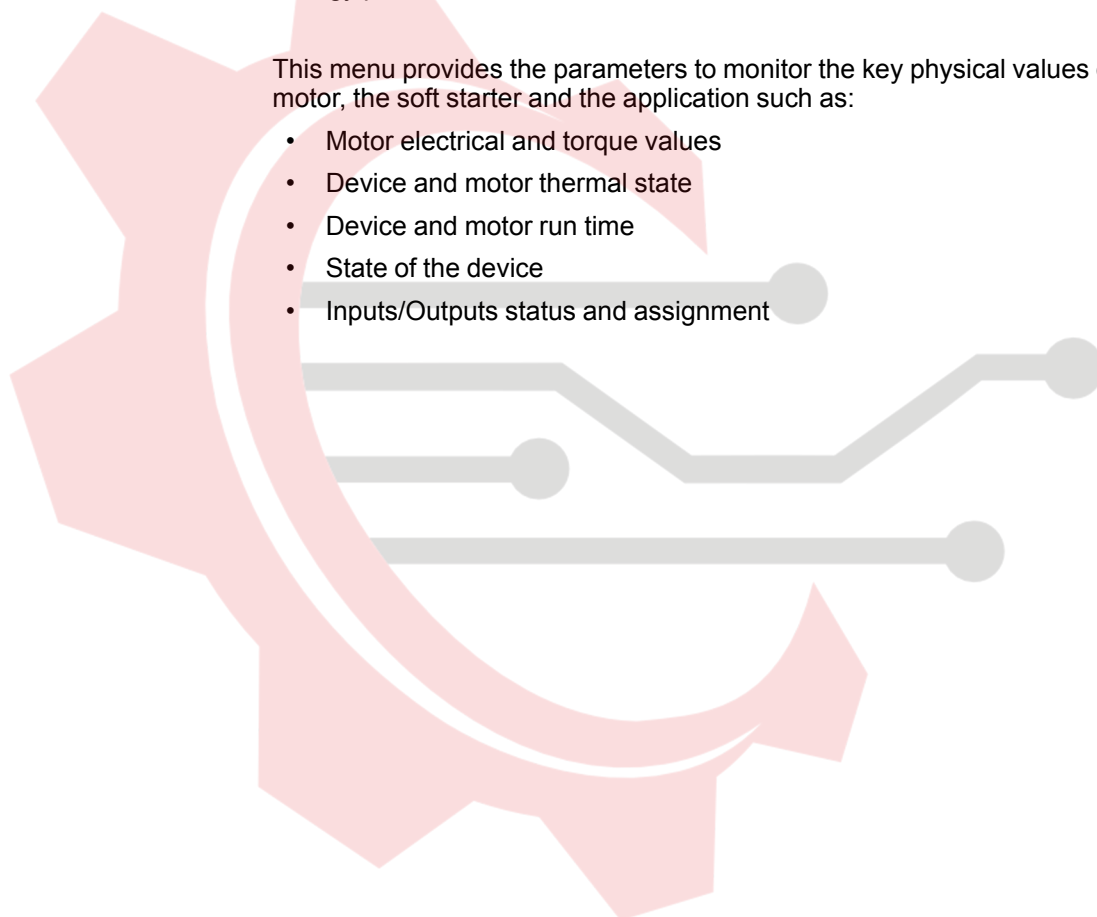

# ماکان کنترول

## Monitor current measurements

This menu provides the parameters to monitor current measurements.

Access path: [Display] → [Currents]

HMI label	Display	Factory setting
[Motor Current] <small>LCR</small>	Unit: Current Unit, page 258.	–
<b>Motor current</b>		
RMS motor current. Average of the three line currents based on the measurement of the fundamental of the motor line currents.		
[Mains Frequency] <small>FAC</small>	0...100.0Hz	–
<b>Mains frequency</b>		
Estimated Frequency value of the mains.		
[Current RMS T1] <small>LCR1</small>	Unit: Current Unit, page 258.	–
<b>Current RMS Phase T1</b>		
[Current RMS T2] <small>LCR2</small>	Unit: Current Unit, page 258.	–
<b>Current RMS Phase T2</b>		
[Current RMS T3] <small>LCR3</small>	Unit: Current Unit, page 258.	–
<b>Current RMS Phase T3</b>		
[Current Unbalance] <small>CUR</small>	NA...100%	–
<b>Estimated Unbalance of the currents</b> (% of Current RMS [Motor Current])		

ماکان کنترول

# Monitor voltage measurements

This menu provides the parameters to monitor voltage measurements.

Access path: **[Display] → [Voltages]**

HMI label	Display	Factory setting
<b>[Mains Voltage]</b> ULNM	0...1000V	–
<b>Mains Voltage (RMS)</b>		
RMS mains voltage. Average of the three line voltage based on the measurement of the fundamental of the mains line voltage.		
<b>[Mains Frequency]</b> FAC	0...100.0Hz	–
<b>Mains frequency</b>		
Estimated Frequency value of the mains.		
<b>[Mains voltage phase 1-2]</b> UL1	0...1000V	–
<b>Mains voltage phase 1-2</b>		
<b>[Mains voltage phase 2-3]</b> UL2	0...1000V	–
<b>Mains voltage phase 2-3</b>		
<b>[Mains voltage phase 3-1]</b> UL3	0...1000V	–
<b>Mains voltage phase 3-1</b>		
<b>[Mains Unbalance Ratio]</b> UMV	0...100%	–
<b>Mains unbalance ratio</b>		
<b>[Mains Unbalance Ratio]</b> UMV is defined as the ratio of the negative sequence voltage component to the positive sequence voltage component.		
<b>[Voltage Sag Counter]</b> MVSC		
<b>Voltage Sag Counter</b>		
A voltage sag is a short-term decrease in voltage levels, typically lasting from a half-cycle to a few seconds.		
If at least one phase to phase voltage drops 10% of mains reference <b>[Mains Voltage]</b> (start of <b>Voltage Sag Counter</b> ) :		
<ul style="list-style-type: none"> <li>The <b>Voltage Sag Counter</b> is incremented. on a ½ cycle and then all phase to phase voltage come back within 10% of mains reference (End of <b>Voltage Sag Counter</b>) within next 6000 ½ cycles (1 minute @50Hz).</li> <li>The <b>Voltage Sag Counter</b> is not incremented. for less than a ½ cycle or all phase to phase voltage come back within 10% of mains reference (End of <b>Voltage Sag Counter</b>) after more than 6000 ½ cycles (1 minute @50Hz).</li> </ul>		
<b>NOTE:</b> a 2% hysteresis around 90% of <b>[Mains Voltage]</b> threshold is used for start and end of <b>Voltage Sag Counter</b> .		
<ul style="list-style-type: none"> <li>The counter can be reset using <b>[Counter Reset]</b>. For more information refer to Counter Management, page 205.</li> <li>A warning <b>[Voltage Sag Warn]</b> is raised when a <b>Voltage Sag Counter</b> has been detected. The warning should be assigned to a warning group in <b>[Warn groups config]</b> to be visible when triggered. Refer to Warning Messages, page 226.</li> </ul>		

## Monitor power measurements

This menu provides the parameters to monitor power measurements.

Access path: [Display] → [Powers]

HMI label	Display	Factory setting
[Power Factor] <i>COS</i>	0.00...1.00	–
<b>Power factor</b>		
[Device Efficiency] <i>DEFF</i>	0...100 %	–
<b>Device efficiency</b>		
[Acv Elc Out Pwr in %] <i>EPR</i>	0...500 %	–
<b>Active Electrical output power in %</b> Active electrical output power in % of motor nominal power.		
[Acv Elc Out Pwr in kW] <i>EPRW</i>	Unit: Electrical Power Unit, page 258.	–
<b>Active Electrical output power in kW</b>		
[Peak Elec Out Power] <i>MOEP</i>	Unit: Electrical Power Unit, page 258.	–
<b>Peak electrical output power</b> Maximum value of electrical power consumed.		
[Input Reactive Power] <i>IQRW</i>	Setting: –3276.7...3276.7 Unit: Reactive Power Unit, page 258.	–
<b>Input reactive power</b>		

ماکان کنترول

## Monitor other measurements

This menu provides the parameters to monitor motor torque, phase direction and real start time.

Access path: **[Display] → [Others]**

HMI label	Display	Factory setting
<b>[Motor Torque]</b> <small>LTR</small>	0...255 % of the nominal torque	–
<i>Torque reference</i>		
<b>[Phase Direction]</b> <small>PHE</small>	–	–
<b>Detected phase direction</b>		
Detect the phase inversion if <b>[Phase Inversion Mon]</b> <small>PHR</small> is configured.		
<ul style="list-style-type: none"> <li>• <b>[123]</b>: direct network (L1 - L2 - L3).</li> <li>• <b>[321]</b>: indirect network (L3 - L2 - L1).</li> </ul>		
<b>[Real Start Time]</b> <small>RSTT</small>	0...1000 s	–
<b>Real Start Time</b>		

ماکان کنترول

## Monitor thermal measurements

This menu provides the parameters to monitor thermal measurements.

Access path: **[Display] → [Thermal Monitoring]**

HMI label	Display	Factory setting
<b>[Motor Therm State]</b> <i>THR</i>	0...300 %	–
<p><b>Motor thermal state</b></p> <p>This parameter monitors the motor thermal state. 100% corresponds to the nominal thermal state at the nominal motor current set to <b>[Motor Nom Current]</b>. For more information, refer to Motor Thermal Protection Class, page 118.</p>		
<b>[Device Thermal State]</b> <i>THS</i>	0...200 %	–
<p><b>Device thermal state</b></p> <p>This thermal estimation is provided by a probe fitted on the heatsink.</p> <p>The value 100 % represents the Nominal thermal state.</p> <ul style="list-style-type: none"> <li>• <b>Warning:</b> <ul style="list-style-type: none"> <li>◦ A warning <b>[Device Th Warn]</b> <i>THA</i> is raised if <b>[Device Thermal State]</b> &gt; 110%.</li> <li>◦ The warning will be cleared if <b>[Device Thermal State]</b> &lt; 105%.</li> </ul> </li> <li>• <b>Error:</b> <ul style="list-style-type: none"> <li>◦ An error <b>[Device Overheat]</b> <i>OHF</i> is triggered if <b>[Device Thermal State]</b> <i>THS</i> &gt; 118%.</li> <li>◦ The error can be reset if <b>[Device Thermal State]</b> <i>THS</i> &lt; 100%.</li> </ul> </li> </ul>		

ماکان کنترول

## Counter Management

This menu provides the parameters to monitor the counters and reset them.

Access path: **[Display] → [Counter Management]**

HMI label	Display	Factory setting
<b>[Motor Run Time]</b> <small>RTHH</small>	0...119304.6 h	0
<b>Motor run time</b> This parameter monitors how long the motor has been energized.		
<b>[Power-on time]</b> <small>PTHH</small>	0...119304.6 h	0
<b>Power-on time</b> This parameter monitors how long the soft starter has been powered-on (control block supplied).		
<b>[Nb Of Starts]</b> <small>NSM</small>	0...4294967295	0
<b>Number of motor starts</b>		
<b>[Bypass Life Cycle]</b> <small>BPCL</small>	0...100 %	0
<b>Bypass contactor life cycle rate</b> Percentage of bypass cycles compared to maximum cycles..		

Access path: **[Display] → [Counter Management]**

OR **[Display] → [Energy parameters]**

HMI label	Display	Factory setting
<b>[Counter Reset]</b> <small>RPR</small>	–	<b>[No]</b> <small>NO</small>
<b>Counter reset</b> Set the parameter to :		
<ul style="list-style-type: none"> <li>• <b>[No]</b>: No counter reset.</li> <li>• <b>[Reset Cons]</b>: to reset the counters of the energy consumption.</li> <li>• <b>[Reset Run Time]</b>: to reset the counter displaying how long the motor has been energized.</li> <li>• <b>[Reset Pw On Time]</b>: to reset the counter displaying how long the soft start has been powered-on.</li> <li>• <b>[Reset Fan Count]</b>: Reset fan operation time.</li> <li>• <b>[Reset Start Count]</b>: to reset the number of motor starts counter.</li> <li>• <b>[Voltage Sag Counter]</b>: Reset voltage sag counter.</li> <li>• <b>[Reset All]</b>: Reset all counters.</li> </ul>		

## Other States

Access path: **[Display] → [Other State]** SST

This menu displays status or state of some applications functions:

- **[Automatic restart]:** Automatic restart attempts in progress.
- **[Type of stop]:** Stop following value set to **[Type of stop]**.
- **[Bypass Active]:** Bypass active.
- **[Steady State]:** Steady state reached.
- **[Wait Before Restart]:** Time before restarting.
- **[Simu Mode Active]:** Simulation Mode is active.



ماکان کنترول

# Input & Output Map

This menu provides the parameters to monitor the functions assigned to the inputs / outputs of the soft starter.

This menu is divided into several sub-menus:

- **[Digital Input Map]**: The mapping of the digital inputs.
- **[Analog inputs image]**: The image of the analog inputs.
- **[Digital Output Map]**: The mapping of the digital outputs and relays.
- **[Analog outputs image]**: The image of the analog outputs.

The parameters available in this menu are in read-only mode, they cannot be configured.

For more information on the inputs/outputs configuration, refer to the menu in **[Input/Output]**, page 156.

Access path: **[Display]** → **[I/O Map]**

## [Digital Input Map]

This menu is used to display the state of digital inputs. Use the touch wheel to scroll through the digital inputs:

On the Display Terminal, select the digital input to see the function assigned to it. This can be used to verify the compatibility with the input/output assignments.

## [Analog inputs image]

This menu is used to display the state of analog inputs. Use the touch wheel to scroll through the analog inputs:

On the Display Terminal, select the analog input to see the function assigned to it. This can be used to verify the compatibility with the input/output assignments.

For more information on analog inputs refer to **[AI1 configuration]** AI1.

## [Analog outputs image]

This menu is used to display the state of analog outputs. Use the touch wheel Up/Down arrows to scroll through the analog outputs:

On the Display Terminal, select the analog output to see all the functions that are assigned to it. This can be used to verify the compatibility with the input/output assignments.

For more information on analog outputs refer to AQ1 Configuration, page 159.

## Energy parameters

This menu provides the parameters to monitor energy consumption.

Access path: [Display] → [Energy parameters]

HMI label	Display	Factory setting
[Acv Elc Out Pwr in kW] <small>EPRW</small>	0...(1) kW	–
<b>Active Electrical output power in kW</b> (1): Max value depends on soft starter rating (see <b>NPR power scaling</b> through communication)..		
[Peak Elec Out Power] <small>MOEP</small>	0...(1) kW	–
<b>Peak electrical output power</b> (1): Max value depends on soft starter rating (see <b>NPR power scaling</b> through communication)..		
[Elc Energy Cons] <small>OC4</small>	0...999 TWh	–
<b>Electrical energy consumed by the motor (TWh)</b>		
[Elc Energy Cons] <small>OC3</small>	0...999 GWh	–
<b>Electrical energy consumed by the motor (GWh)</b>		
[Elc Energy Cons] <small>OC2</small>	0...999 MWh	–
<b>Electrical energy consumed by the motor (MWh)</b>		
[Elc Energy Cons] <small>OC1</small>	0...999 kWh	–
<b>Electrical energy consumed by the motor (KWh)</b>		
[Elc Energy Cons] <small>OC0</small>	0...999 Wh	–
<b>Electrical energy consumed by the motor (Wh)</b>		
[Elc EGY Today] <small>OCT</small>	0...4,294,967,295 kWh	–
<b>Electrical energy consumed TODAY by the motor (KWh)</b>		
[Elc EGY Yesterday] <small>OCY</small>	0...4,294,967,295 kWh	–
<b>Electrical energy consumed YESTERDAY by the motor (KWh)</b>		
[Reactive Energy] <small>IRE4</small>	0...999 TVARh	–
<b>Electrical Input Reactive energy (TVARh)</b>		
[Reactive Energy] <small>IRE3</small>	0...999 GVARh	–
<b>Electrical Input Reactive energy (GVARh)</b>		
[Reactive Energy] <small>IRE2</small>	0...999 MVARh	–
<b>Electrical Input Reactive energy (MVARh)</b>		
[Reactive Energy] <small>IRE1</small>	0...999 kVARh	–
<b>Electrical Input Reactive energy (KVARh)</b>		
[Reactive Energy] <small>IRE0</small>	0...999 VARh	–
<b>Electrical Input Reactive energy (VARh)</b>		
[Counter Reset] <small>RPR</small>	–	[No] <small>NO</small>
<b>Counter reset</b> Refer to Counter Management , page 205.		

## Diagnostics and Troubleshooting

### What's in This Part

Front Product LEDs .....	210
Diagnostic Data .....	211
Error History .....	213
Warnings .....	215
Fan diagnostic .....	216
Error and Warning Handling .....	218
Security Event Logging .....	221
Troubleshooting .....	223
Warning messages and error codes.....	225

This menu provides the error and warning history of the soft starter.

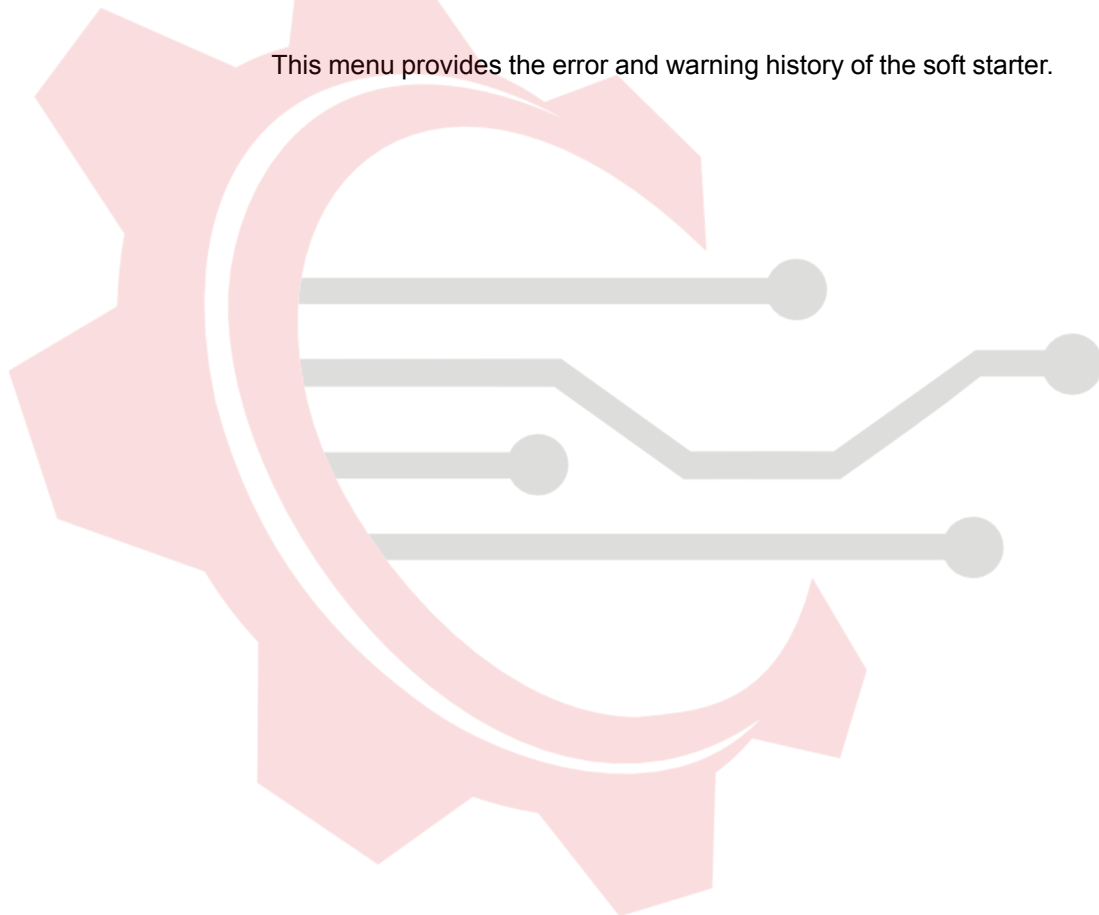

ماکان کنترول

## Front Product LEDs

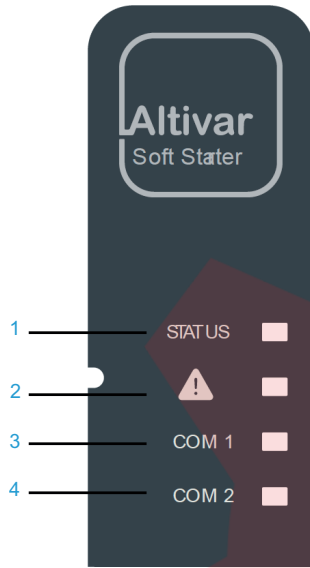

Item	LED	Description
1	<b>STATUS</b>	Bicolor Green/Yellow LED indicating soft starter states
2	<b>Warning/Error</b>	Red LED indicating whether a warn/error is active. It is in addition to warn/error info display on Display terminal LCD
3	<b>COM 1</b>	Yellow LED indicating Modbus serial activity on port RJ45 Modbus VP
4	<b>COM 2</b>	Yellow LED indicating Open-Style Modbus activity.

ماکان کنترول

# Diagnostic Data

This menu provides the parameters to display the last warning and last detected error in addition to device data.

Access path: **[Diagnostics] → [Diag. data]**

HMI label	Setting	Factory setting
<b>[Last Error]</b> <i>LFT</i>	–	–
<b>Last error occurred</b> Last error which occurred. The list of error codes is available in the chapter How To Clear the Error Codes?, page 224.		
<b>[Last Warning]</b> <i>LALR</i>	–	–
<b>Last warning</b> Last warning which occurred. The list of warning codes is available in the chapter List of Available Warning Messages.		
<b>[Cust Supply Diag]</b> <i>CPSF</i>		
<b>Customer supply error diagnostic</b> <ul style="list-style-type: none"> <li>• 0x00: No power supply error detected since startup</li> <li>• 0x11: Overcurrent detected on customer 24V supply</li> <li>• 0x21: Overvoltage detected on customer 24V supply</li> <li>• 0x31: Too many short under-voltages detected on customer 24V supply</li> </ul> This parameter can be accessed only if <b>[Cust Supply Error]</b> <i>CPSF</i> error is triggered.		
<b>[Service Message]</b> <i>SER</i>	–	–
This menu presents the service message. This service message is defined using <b>[My preferences] → [Customization] → [Service Message]</b> menu.		
<b>[LED Diagnostics]</b> <i>HLT</i>	–	–
This starts a test sequence to verify the states of the LEDs.		
<b>[Customer Supply 24V]</b> <i>SUP1</i>	0.0...6553.5 V	–
24V customer supply monitoring		
<b>[Control Supply 24V]</b> <i>SUP2</i>	0.0...6553.5 V	–
24V control supply monitoring		
<b>[Control Supply 13V]</b> <i>SUP3</i>	0.0...6553.5 V	–
12V (from RJ45) supply monitoring		
<b>[Power Supply 12V]</b> <i>SUP6</i>	0.0...6553.5 V	–
12V power supply monitoring		
<b>[Clear Error History]</b> <i>RFLT</i>	<b>[No]</b> or <b>[Yes]</b>	<b>[No]</b>
<b>Clear error history</b> <ul style="list-style-type: none"> <li>• <b>[No]</b>: Do not clear error history.</li> <li>• <b>[Yes]</b>: Clear error history.</li> </ul>		

HMI label	Setting	Factory setting
[Phase Loss Status] <i>OPFS</i>	–	–
Status on the loss of the motor phases. <b>Only available in <i>RDY</i>, <i>RUN</i> and <i>BYP</i> states.</b> <ul style="list-style-type: none"> <li>• [No Phase Loss] = No Phase Loss</li> <li>• [Loss of Phase 1] = phase 1 loss</li> <li>• [Loss of Phase 2] = phase 2 loss</li> <li>• [Loss of Phase 1&amp;2] = phase 3 loss</li> <li>• [Loss of Phase 3] = phase 1 &amp; 2 Loss</li> <li>• [Loss of Phase 1&amp;3] = phase 1 &amp; 3 Loss</li> <li>• [Loss of Phase 2&amp;3] = phase 2 &amp; 3 Loss</li> <li>• [All Phases Loss] = phase 1,2 &amp; 3 Loss</li> <li>• [Undef Phase Loss] = phase loss not determined</li> <li>• [Result Not Available] = result not available</li> </ul>		
[Mains Loss Status] <i>PHFS</i>	–	–
Status on the loss of the mains phases. <b>The power supply A1/A2 must be powered up to start this function..</b> <ul style="list-style-type: none"> <li>• [No Phase Loss] = No Phase Loss</li> <li>• [Loss of Phase 1] = phase 1 loss</li> <li>• [Loss of Phase 2] = phase 2 loss</li> <li>• [Loss of Phase 1&amp;2] = phase 3 loss</li> <li>• [Loss of Phase 3] = phase 1 &amp; 2 Loss</li> <li>• [Loss of Phase 1&amp;3] = phase 1 &amp; 3 Loss</li> <li>• [Loss of Phase 2&amp;3] = phase 2 &amp; 3 Loss</li> <li>• [All Phases Loss] = phase 1,2 &amp; 3 Loss</li> <li>• [Undef Phase Loss] = phase loss not determined</li> <li>• [Result Not Available] = result not available</li> </ul>		
[Bypass Life Cycle] <i>BPCL</i>	0...100%	–
Percentage of bypass cycles compared to maximum cycles.		
[Bypass Diagnostics] <i>BPED</i>	–	–
Bypass Error Diagnostic: <ul style="list-style-type: none"> <li>• [Bypass Operational]</li> <li>• [Contactor 1 Error] : Bypass 1 Error</li> <li>• [Contactor 2 Error] : Bypass 2 Error</li> <li>• [Contactor 1&amp;2 Error] : Bypass 1 and 2 Error</li> <li>• [Contactor 3 Error] : Bypass 3 Error</li> <li>• [Contactor 1&amp;3 Error] : Bypass 1 and 3 Error</li> <li>• [Contactor 2&amp;3 Error] : Bypass 2 and 3 Error</li> <li>• [All Contactors Error] : Bypass 1, 2 and 3 Error</li> <li>• [Undef Bypass Error] : Bypass Error not determined</li> <li>• [Result Not Available]</li> </ul>		
[Product restart] <i>RP</i>	–	[Not Assigned] <i>NO</i>
<b>Product restart</b> For more information, refer to Product Restart, page 170.		

# Error History

This menu shows the 15 last detected errors. Pressing **OK** key on the selected error code in the **[Error history]** list displays the soft starter data recorded when the error has been detected.

Errors are stored and time-stamped on the soft starter. This information is displayed on the graphic display terminal, and can be downloaded and viewed in the DTM as well as on the web server.

**NOTE:** Same content for **[Last Error 1]** to **[Last Error 15]**.

**NOTE:** How To Clear the Error Code is available in the chapter How To Clear the Error Codes?, page 224.

Access path: **[Diagnostics]** → **[Errors]**

The following table shows the detailed information stored before the **[Last Error 1]** triggered:

HMI label	Setting	Factory setting
<b>[Device State]</b> HS1	–	–
HMI status of the error record 1.		
<b>[Last Error 1 Status]</b> EP1	–	–
Status word of the error record 1.		
<b>[ETI state word]</b> IP1	–	–
Extended status word of the error record 1.		
<b>[Cmd word]</b> CMP1	–	–
Command word of the error record 1.		
<b>[Motor current]</b> LCP1	–32767...32767 A Unit: 0.1 A. or 1 A according to the soft starter rating.	–
Current motor value (RMS) of the error record 1.		
<b>[Run Elapsed time]</b> RTP1	0..65535 h	–
Run time of the error record 1.		
<b>[Motor therm state]</b> THP1	0...300 %	–
Motor thermal state of the error record 1. This parameter monitors the motor thermal state. 100% corresponds to the nominal thermal state at the nominal motor current set to <b>[Motor Nom Current]</b> .		
<b>[Command Channel]</b> DCC1	–	–
Channel command active of the error record 1. <ul style="list-style-type: none"> <li>• <b>[Terminals]</b> TER: terminal channel.</li> <li>• <b>[HMI]</b> LCC: Graphic display channel.</li> <li>• <b>[Modbus]</b> MDB: Modbus channel.</li> <li>• <b>[PC tool]</b> PWS: DTM based commissioning software.</li> </ul>		
<b>[Motor Torque]</b> OTP1	0...255 % of the nominal torque	–
Motor torque of the error record 1.		
<b>[Device Thermal State]</b> TSP1	0...200%	–
Device thermal state of the error record 1. The value 100 % represents the Nominal thermal state.		

HMI label	Setting	Factory setting
<b>[Warn Group Status]</b> AGP1	–	–
Warning group status of the error record 1. List of possible warning is available, page 223.		
<b>[Mains Max Inst. Volt.]</b> ULM1	–	–
Maximum Voltage value of error record.		

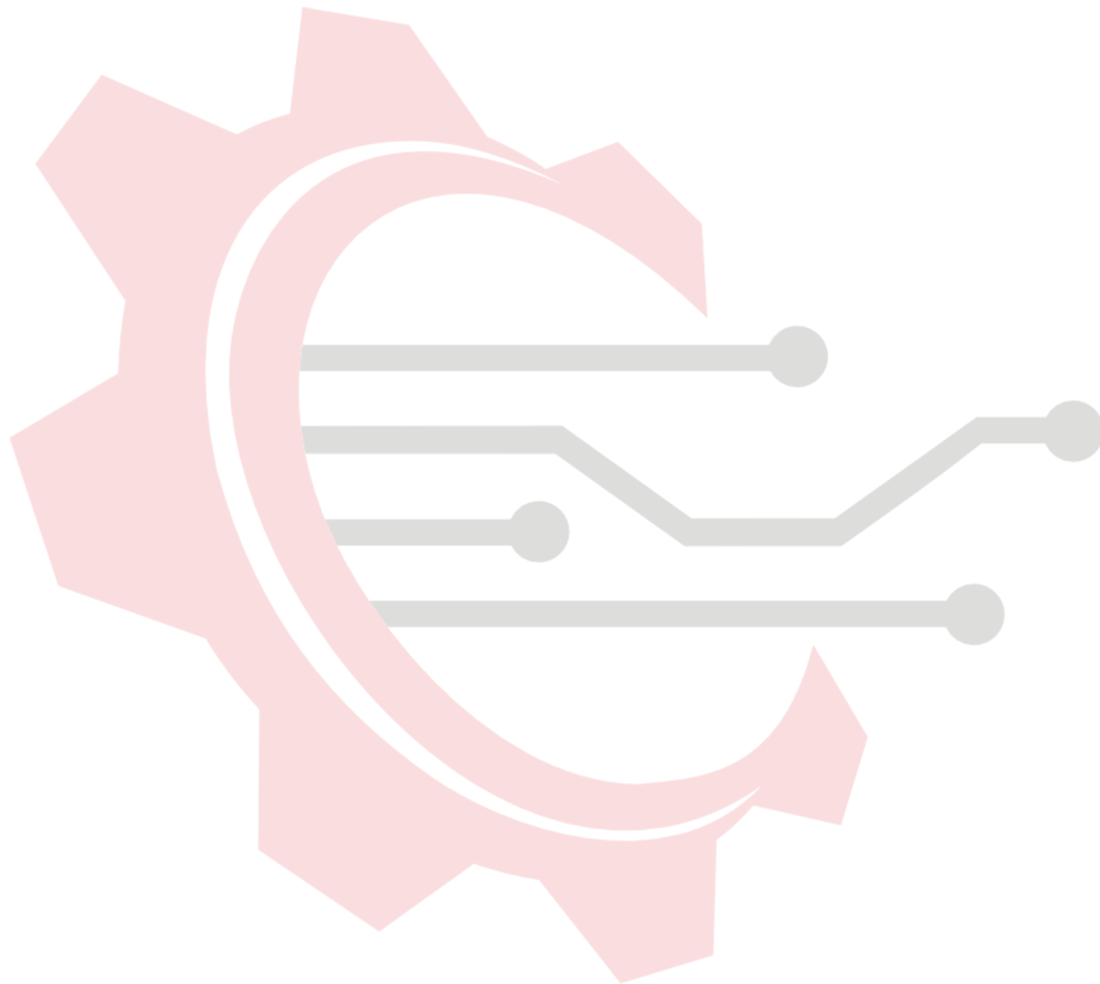

ماکان کنترول

# Warnings

This menu presents the current warnings and warning history. The list of warning codes is available in the chapter List of Available Warning Messages, page 226.

**NOTE:** Any warning that is triggered but is not assigned to a warning group will not be visible on the display terminal, will not be signaled by the LED of the soft starter and will not be logged.

Access path: **[Diagnostics] → [Warnings]**

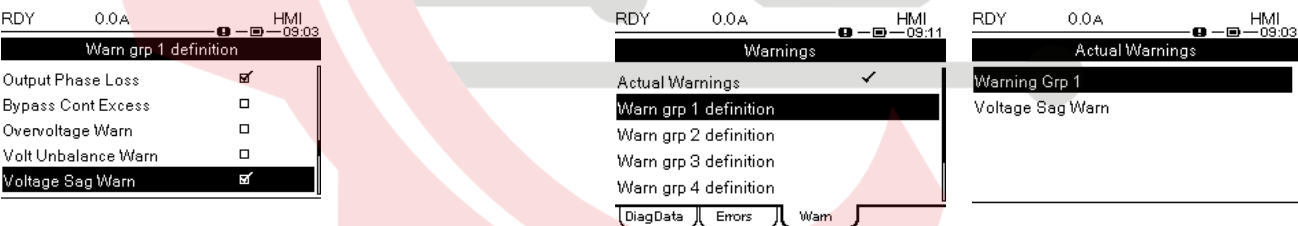
HMI label	Setting	Factory setting
<b>[Actual Warnings]</b> ALRD	–	–
<p>List of current warnings.</p> <p>If warning is active and not in warning group, only ✓ is displayed:</p> 		
<p>If warning is active and in warning group ✓ and ! are displayed:</p> 		
<b>[Warn grp 1 definition]</b> A1C to <b>[Warn grp 5 definition]</b> A5C	–	–
<p>The following submenus groups the warnings into 1 to 5 groups, each of which can be assigned to a relay or a digital output for remote signalling.</p> <p>When one or several warning(s) selected in a group occur(s), this actual warning and the output are activated.</p>		
<b>[Warning History]</b> ALH	–	–
<p>This menu presents the warning history (30 past warnings).</p> <p>Warnings are stored and time-stamped on the soft starter. This information is displayed on the graphic display terminal, and can be downloaded and viewed in the DTM as well as on the web server.</p>		

# Fan diagnostic

## What's in This Chapter

Fan status..... 216  
 Fan diagnostics test..... 217  
 Fan Counter Reset ..... 217

**NOTE:** This menu is not available for product size lower than ATS430D88S6.

## Fan status

Access path: **[Diagnostics] → [Fan diagnostic] → [Fan status]**

HMI label	Setting range	Factory setting
[Fan status register] <i>F PAD</i>	-	-
<b>Fan operating status register</b> An event means that a warning on fan speed or operating time of the fan is elapsed and therefore tells which fan to check. <ul style="list-style-type: none"> <li>• [No Warning]</li> <li>• [Event On Fan 1]</li> <li>• [Event On Fan 2]</li> <li>• [Event On Fans 1&amp;2]</li> <li>• [Event On All Fans]</li> <li>• [Undefined Fan Event]</li> <li>• [Result Not Available]</li> </ul>		
[Fan 1 status] <i>FFA1</i> [Fan 2 status] <i>FFA2</i>	-	-
<b>Fan 1 operating status, Fan 2 operating status</b> <ul style="list-style-type: none"> <li>• [OK]: no event</li> <li>• [Warning]: event of low speed or operating time of the fan elapsed.</li> <li>• [Error]: event of very low speed (near 0 rpm).</li> </ul>		
[Fan 1 run time] <i>FPT1</i> [Fan 2 run time] <i>FPT2</i>	0...500000 h	-
<b>Fan 1 operating time, Fan 2 operating time</b>		
[Fan 1 speed] <i>FSP1</i> [Fan 2 speed] <i>FSP2</i>	0...65535 rpm	-
<b>Fan 1 operating speed, Fan 2 operating speed</b>		
[Fan Run Time Thld] <i>FPTA</i>	[Default]; 1...65535 h	[Default]
<b>Fan operating time threshold</b> Threshold on the number of hours of operating time to generate an error [Fan Feedback Error] <i>FFDF</i> .		

## Fan diagnostics test

Access path: **[Diagnostics] → [Fan diagnostic] → [Fan Diagnostics Test]**

HMI label	Setting range	Factory setting
<b>[Fan Diagnostics test]</b> <i>FNT</i>	-	-
<p>A test of fans can be launched to check operation of the fans functionality with <b>[Fan Diagnostics test]</b>.</p> <ul style="list-style-type: none"> <li>The diagnostic can only be run in Stop mode.</li> <li>The diagnostic consists in Force turning ON the Fans for 40s (do not press ESC during this time) and checks :                             <ul style="list-style-type: none"> <li>Each fan speed :                                     <ul style="list-style-type: none"> <li>If speed is above the normal operation limit, the result is <b>[OK]</b>..</li> <li>If speed is between minimum and maximum operation limit, the result is <b>[Warning]</b>.</li> <li>If speed is below the minimum operation limit, the result is <b>[Error]</b>.</li> </ul> </li> </ul> </li> <li>Each fan stop, result is <b>NOK</b> if fan does not stop.</li> <li>The diagnostic results of each fan are given in <b>[Fan Diagnostics test]</b>:                             <ul style="list-style-type: none"> <li><b>[Fan Diagnostics test]</b> indicates results of:                                     <ul style="list-style-type: none"> <li><b>[Fan1 Speed Warn sts]</b>: Fan 1 low speed.</li> <li><b>[Fan1 Speed Error sts]</b>: Fan 1 not stopping.</li> <li><b>[Fan1 No Speed sts]</b>: Fan 1 no speed.</li> <li><b>[Fan2 Speed Warn sts]</b>: Fan 2 low speed.</li> <li><b>[Fan2 Speed Error sts]</b>: Fan 2 not stopping.</li> <li><b>[Fan2 No Speed sts]</b>: Fan 2 no speed.</li> </ul> </li> <li><b>[Fan Diagnostics test]</b> is reset at each test.</li> </ul> </li> </ul>		

## Fan Counter Reset

This menu is used to reset fan counters.

Access path: **[Diagnostics] → [Fan diagnostic] → [Counter reset]**

HMI label	Setting range	Factory setting
<b>[Reset Fan 1 Run Time]</b> <i>FTR1</i>	<b>[No]</b> or <b>[Yes]</b>	<b>[No]</b>
<i>Reset fan 1 operating time</i>		
<b>[Reset Fan 2 Run Time]</b> <i>FTR2</i>	<b>[No]</b> or <b>[Yes]</b>	<b>[No]</b>
<i>Reset fan 2 operating time</i>		

## Error and Warning Handling

This menu provides the parameters to manage the errors and warnings handling.

Access path: **[Complete settings] → [Error/Warn handling]**

HMI label	Setting	Factory setting
<b>[Ext Error assign]</b> <i>E<sub>TF</sub></i>	–	<b>[Not Assigned]</b> <i>NO</i>
<p><b>External error assignment</b></p> <p>This parameter assigns the detection of the <b>[External Error]</b> <i>E<sub>PF1</sub></i> error to DI3, DI4 or a virtual input. The level of detection on the assigned input is set by <b>[Ext Error Condition]</b> <i>E<sub>LT</sub></i>.</p> <ul style="list-style-type: none"> <li><b>[Not Assigned]</b>: External error not assigned.</li> <li><b>[DI•]</b>: External error assigned to digital input <b>[DI•]</b> (high and low level).</li> <li><b>[CD••]</b>: External error assigned to line channel. Refer to the fieldbus manuals for the CMD word assignments.</li> </ul>		
<b>[Ext Error Condition]</b> <i>E<sub>LT</sub></i>	–	<b>[High Level]</b> <i>HIGH</i>
<p><b>External error condition</b></p> <p>This parameter sets at which level the detection of <b>[External Error]</b> occurs on the assigned digital input.</p> <ul style="list-style-type: none"> <li><b>[High Level]</b>: External error detected at high level</li> <li><b>[Low Level]</b>: External error detected at low level</li> </ul> <p>When <b>[Ext Error Condition]</b> is set to <b>[High Level]</b>, accidental disconnection of the cable connected to the digital input assigned to <b>[Ext Error assign]</b> is not detected.</p>		
<h3>⚠ WARNING</h3>		
<p><b>LOSS OF CONTROL</b></p> <ul style="list-style-type: none"> <li>Verify that the setting of this parameter does not result in unsafe conditions.</li> <li>Set this parameter to <b>[Low Level]</b> if you want to detect accidental disconnection of the cable connected to the digital input assigned to <b>[Ext Error assign]</b>.</li> </ul> <p><b>Failure to follow these instructions can result in death, serious injury, or equipment damage.</b></p>		
<b>[Ext Error Resp]</b> <i>E<sub>PL</sub></i>	–	<b>[Freewheel Stop]</b> <i>YES</i>
<p><b>Device response to external error</b></p> <p><b>NOTE:</b> <b>[Ext Error Resp]</b> appears if <b>[Ext Error assign]</b> is assigned.</p> <p>This parameter sets the behavior on <b>External error condition</b>:</p> <ul style="list-style-type: none"> <li><b>[Ignore]</b>: Trigger <b>[Ext. Error Warn]</b> <i>E<sub>FA</sub></i>. The warning should be assigned to a warning group in <b>[Warn groups config]</b> to be visible when triggered. Refer to Warning Messages, page 226.</li> <li><b>[Freewheel Stop]</b>: Error <b>[External Error]</b> <i>E<sub>PF1</sub></i> is triggered and motor stops in freewheel.</li> <li><b>[Configured Stop]</b>: Motor stops according to the value set in <b>[Type of stop]</b>, <b>[Ext. Error Warn]</b> <i>E<sub>FA</sub></i> is triggered.</li> <li><b>[Deceleration]</b>: Motor stops in deceleration and an error <b>[External Error]</b> <i>E<sub>PF1</sub></i> is triggered at the end of deceleration.</li> </ul>		

HMI label	Setting	Factory setting
<b>[Auto Fault Reset]</b> <i>ATR</i>	–	<b>[No]</b> <i>NO</i>
<p><b>Automatic fault reset</b></p> <p>This parameter enables the automatic reset of the soft starter after the triggered error has been cleared.</p> <p>For more information about errors codes affected by <b>[Auto Fault Reset]</b>, refer to Troubleshooting, page 223.</p> <ul style="list-style-type: none"> <li>• <b>[No]</b>: disables automatic reset.</li> <li>• <b>[Yes]</b>: allows automatic reset.</li> </ul> <p>This function can be used to automatically perform individual or multiple Fault Resets. If the cause of the error that has triggered the transition to the operating state Fault disappears while this function is active, the device resumes normal operation. While the Fault Reset attempts are performed automatically, the output signal "Operating state Fault" is not available. If the attempts to perform the Fault Reset are not successful, the device remains in the operating state Fault and the output signal "Operating state Fault" becomes active.</p>		
<p><b>⚠ WARNING</b></p>		
<p><b>UNANTICIPATED EQUIPMENT OPERATION</b></p> <ul style="list-style-type: none"> <li>• Verify that activating this function does not result in unsafe conditions.</li> <li>• Verify that the fact that the output signal "Operating state Fault" is not available while this function is active does not result in unsafe conditions.</li> </ul> <p><b>Failure to follow these instructions can result in death, serious injury, or equipment damage.</b></p>		
<p>The relay assigned to <b>[Operating State Fault]</b> remains closed if this function is running as long as <b>[Fault Reset Time]</b> is not elapsed.</p> <p>It is recommended to use 2–wire control to be able to perform an automatic restart of the motor, if the RUN command is maintained, after an automatic reset of the device.</p> <p>In 3–wire control the motor will not automatically restart.</p>		
<b>[Fault Reset Time]</b> <i>TAR</i>	–	<b>[5 minutes]</b> <i>5</i>
<p><b>Fault Reset time</b></p> <p>This parameter sets the maximum time for a successful automatic reset when it is configurable.</p> <p>If <b>[Fault Reset Time]</b> is elapsed before a successful automatic reset, the soft starter can only be reset with a manual reset.</p> <p>For more information about errors codes affected by <b>[Auto Fault Reset]</b>, refer to Troubleshooting, page 223.</p> <ul style="list-style-type: none"> <li>• <b>[5 minutes]</b>: 5 minutes for successful automatic restart</li> <li>• <b>[10 minutes]</b>: 10 minutes for successful automatic restart</li> <li>• <b>[30 minutes]</b>: 30 minutes for successful automatic restart</li> <li>• <b>[1 hour]</b>: 1 hour for successful automatic restart</li> <li>• <b>[2 hours]</b>: 2 hours for successful automatic restart</li> <li>• <b>[3 hours]</b>: 3 hours for successful automatic restart</li> <li>• <b>[Unlimited]</b>: Unlimited time for successful automatic restart</li> </ul> <p>This parameter can be accessed if <b>[Auto Fault Reset]</b> is set to <b>[Yes]</b>.</p>		
<b>[Disable Error Detect]</b> <i>INH</i>	–	<b>[Not Assigned]</b> <i>NO</i>
<p>For more information, refer to Smoke Extraction, page 148.</p>		
<b>[Forced Run]</b> <i>INHS</i>	–	<b>[Disabled]</b> <i>NO</i>
<p>For more information, refer to Smoke Extraction, page 148.</p>		

HMI label	Setting	Factory setting
[Fault Reset Assign] <i>RSF</i>	–	[Not Assigned] <i>NO</i>
<p><b>Fault reset input assignment</b></p> <p>This parameter sets the digital input for a manual reset on rising edge.</p> <p>If no digital input is set, a manual reset is possible by applying a Run order.</p> <p>This parameter <b>does not</b> reset the [Motor Overload] error.</p> <ul style="list-style-type: none"> <li>• [Not Assigned]: Manual reset not assigned.</li> <li>• [DI•]: Manual reset assigned to digital input [DI•] on rising edge.</li> </ul> <p><b>NOTE:</b> in [Standard Profile], the <i>BIT 7</i> of the CMD register is assigned to [Fault Reset Assign]. For more information, refer to communication manuals.</p> <p><b>NOTE:</b> In [I/O profile], [Fault Reset Assign] can be assigned to a virtual input [CD••].</p>		
[Product restart] <i>RP</i>	–	[Not Assigned] <i>NO</i>
For more information, refer to Product Restart, page 170.		
[Control Supply Loss] <i>CLB</i>	–	[Error] <i>0</i>
<p><b>Response to control supply loss</b></p> <p>This parameter sets the soft starter behavior when the control supply on A1 and A2 is out of range.</p> <ul style="list-style-type: none"> <li>• [Error]: Triggers the [Control Supply Error] error. Opens the relay R1 if it is assigned to [Operating State Fault] and if [Auto Fault Reset] is set to [No].</li> <li>• [Error w/o Relay]: Triggers the [Control Supply Error] error and keeps the relay assigned to [Operating State Fault] closed.</li> <li>• [Warning]: triggers the [Ctrl Supply Loss] warning instead of triggering [Control Supply Error].</li> </ul> <p><b>NOTE:</b></p> <p>The [Ctrl Supply Loss] warning will trigger only if:</p> <ul style="list-style-type: none"> <li>• If is added to a warning group definition in [Diagnostics] → [Warnings].</li> <li>• The soft starter loses the control supply on A1 / A2 while not in operating state [Running]. Otherwise the [Control Supply Error] will trigger instead.</li> </ul>		

## [Warn groups config]

Access path to assigned a warning: [Complete settings] → [Warn groups config]

This sub-menu sets the configuration of the following warning groups:

- [Warn grp 1 definition].
- [Warn grp 2 definition].
- [Warn grp 3 definition].
- [Warn grp 4 definition].
- [Warn grp 5 definition].

When a warning is triggered, the relay set to the triggered warning group is activated.

**NOTE:**

Any triggered warning that is not assigned to a warning group will not be visible on the display terminal, will not be signaled by the LEDs of the soft starter and will not be logged.

**NOTE:** A list of possible warning is available here: List of Available Warning Messages, page 226.

## Security Event Logging

The following time-stamped events are logged in a dedicated security log file:

- User authentications, authentication and logout attempts
- Security parameter changes
- Access to the security events
- Device reboot, startup
- Device hardware modifications and software updates
- Device Configuration Integrity changes (restore, download or factory settings)

The Altivar Soft Starter ATS430 can store up to 500 events, a warning is raised when the log base is reaching 90% of capacity. This warning can be acknowledged with commissioning tool (DTM). When the maximum capacity is reached, the 50 oldest events are erased.

If access control is disabled, any security event is identified as ADMIN action.

Embedded Device provides the capability to determine whether a given human took a particular action. The link is established between the user identifier, the action realized and the timestamping of the action (date and time) to provide an efficient source of security logging.

Irrelevant date & time can result in false interpretation of the security event logging and lead to either false positive or undetectable security threat detection.

### **NOTICE**

#### **WRONG TIMESTAMPING RESULT IN NON-REPUDIATION ISSUE**

- Verify and regularly realign the synchronization of the device data & time.

**Failure to follow these instructions can result in equipment damage.**

The security events can be read from SoMove, DTM and EcoStruxure Control Expert. For security reasons, security logs are stored in a database to which read-only access is provided. There is no possibility to edit or erase this log database.

The format system log record follows the syntax defined by Syslog RFC-5424 2009 and the semantic normalized by Schneider Electric.

Below is an example of this format:

```
<86>1 2024-01-24T09:59:53.06Z MyDevice ATS430 Credential USERACCOUNT_CHANGE [cred@3833 name="ADMIN"] Password changed
```

Elements from the example, from left to right	Syslog word	Description
<86>	PRI	Event priority (81 for alert events, 85 for notice events, 86 for informational events)
1	VERSION	Syslog protocol version
2024-01-24T09:59:53.06Z	TIMESTAMP	Date and time in UTC
MyDevice	HOSTNAME	Device name, or serial number if <b>[Device Name]</b> PAN is not defined
ATS430	APP-NAME	Product commercial reference
Credential	PROCID	Identify the process and the network protocol service that originated the message
USERACCOUNT_CHANGE	MSGID	Identify the type of event
[cred@3833 name="ADMIN"]	STRUCTURED-DATA	Event information depending on the event category: <ul style="list-style-type: none"> <li>• [ authn@3833 ] • Structured-data used for authentication events</li> <li>• [ authz@3833 ] • Structured-data used for authorization events</li> <li>• [ config@3833 ] • Structured-data used for configuration events</li> <li>• [ cred@3833 ] • Structured-data used for credential management events</li> <li>• [ system@3833 ] • Structured-data for events in the system that are not captured by other event types like operating mode state change or hardware failure</li> <li>• [ backup@3833 ] • Structured data used for backup</li> </ul>
Password changed	MSG	Message containing event specific information, if any

ماکان کنٹرل

# Troubleshooting

## Soft Starter Does Not Start, No Error Code Displayed

1. If no display: verify the soft starter supply.
2. Check if **[No Mains Voltage]** **NLP** appears on the display terminal. Verify the presence of power.
3. Soft starter maybe blocked in **[Freewheel]** **NST** state. Refer to How to interpret and react to a NST state, page 257.
4. Soft starter maybe blocked in **[Wait for Restart]** **TBS** state.

## Soft Starter Does Not Start, Error Code Displayed

Step	Action
1	Disconnect all power, including external control power that may be present.
2	Lock all power switches in the open position.
3	Verify the absence of voltage using a properly rated voltage sensing device.
4	Find and correct the cause of the detected error. Refer to the list of possible detected errors.
5	Restore power to the soft starter to confirm that the detected error has been cleared.

When an error is triggered the Warning/Error led is red on.

The soft starter behavior can be set for the following errors:

- **[Ext Error Resp]** **EPL**
- **[Voltage Error Resp]** **MVFB**
- **[Overload ErrorResp]** **ODL**
- **[Underload ErrorResp]** **UDL**
- **[Modbus Error Resp]** **SLL**
- **[Long Start Error Resp]** **STB**
- **[AI1 Th Error Resp]** **TH1B**

For all other detected errors the soft starter stop in freewheel.

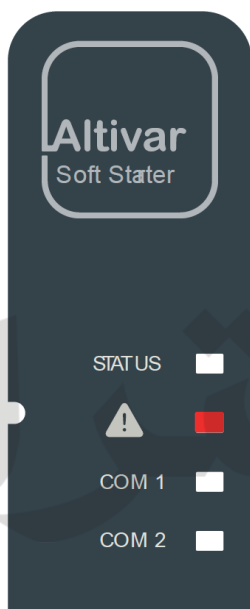

## How To Clear the Error Codes?

The following table summarizes the possibilities to clear a detected error:

How to clear the error code after the cause has been removed	List of the cleared errors
<p><b>Power reset:</b></p> <ul style="list-style-type: none"> <li>Power reset of the soft starter.</li> <li><b>[Product restart]</b> or <b>[Prod Restart Assign]</b> used.</li> </ul>	All detected errors.
<p><b>Manual reset:</b></p> <p>Perform one of the following actions to reset the device:</p> <ul style="list-style-type: none"> <li>Press <b>STOP / RESET</b> key, if the active command channel is the terminal.</li> <li>Apply a rising edge to the digital input assigned to <b>[Fault Reset]</b>, if the active command channel is the terminal.</li> <li>Activate the digital input <i>RUN</i> if <b>[Fault Reset]</b> is not assigned. Activate the digital input <i>RUN</i> a second time to start the motor. Consider the value set to the active command channel is the terminal.</li> <li>In case of line channel action must be done through CMD (see the communication manual).</li> </ul>	<p>EPF1, OHF, OLF, SLF1, TJF, TLSF</p> <p>And all the error codes belonging to the following categories, after the automatic reset time is elapsed:</p> <ul style="list-style-type: none"> <li><b>Automatic reset</b></li> <li><b>Automatic reset limited duration</b></li> <li><b>Automatic reset limited retry and limited duration</b></li> </ul>
<p><b>Automatic reset:</b></p> <ul style="list-style-type: none"> <li>A series of automatic attempts are made to reset the error at given intervals for an unlimited time or number of attempts.</li> <li><b>[Auto Fault Reset]</b> must be set to <b>[Yes]</b></li> <li>In case of <b>[Supply Mains OverV]</b> OSF or <b>[Supply Mains UnderV]</b> USF, the relay assigned to <b>[Operating State Fault]</b> does not open.</li> </ul>	CLF, OSF, USF
<p><b>Automatic reset limited duration:</b></p> <ul style="list-style-type: none"> <li>A series of automatic attempts are made to reset the error with a maximum time for a successful automatic reset set with <b>[Fault Reset Time]</b> TAR</li> <li><b>[Auto Fault Reset]</b> must be set to <b>[Yes]</b></li> <li>At the end of the attempt, if the error is still present, the device remains in error state, and if a relay is assigned to <b>[Operating State Fault]</b>, it is opened. a <b>manual reset</b> or a <b>power reset</b> is then required.</li> </ul>	INFb, SLF2, SLF3, T1CF, TH1F, ULF
<p><b>Automatic reset limited duration and limited retry:</b></p> <ul style="list-style-type: none"> <li>A series of automatic attempts are made to reset the error at given intervals for a configured time <b>[Fault Reset Time]</b> TAR before disabling the sequence if the current error persist.</li> <li><b>[Auto Fault Reset]</b> must be set to <b>[Yes]</b></li> <li>At the end of attempt, if the error is still present, the device remains in error state and if a relay is assigned to <b>[Operating State Fault]</b>, it is opened. A <b>manual reset</b> is then required.</li> <li><b>[Fault Reset Time]</b> is limited to <b>3 hours</b>.</li> <li>The error is logged only once during <b>[Fault Reset Time]</b>, the first time the error occurs.</li> </ul> <p>During <b>[Fault Reset Time]</b>, any new occurrence of a given error is considered a new attempt (if no other error has occurred in the meantime).</p>	FRF, LCCF, LCF, MDDF, NOSF, OLC, OPF, PHF, PIF, SDF
<p><b>Transient:</b></p> <ul style="list-style-type: none"> <li>As soon as its cause has been removed.</li> </ul>	CFF, CFI, CFI2, FWER, FMMC, FWPF, INFZ, SPFC, SPTF

# Warning messages and error codes

## What's in This Chapter

Warning Messages.....	226
[Line Short Circuit] BYF1 .....	229
[Bypass Closing Error] BYF2 .....	229
[Bypass Open Error] BYF3.....	229
[ByPass Overcurrent] BYF4.....	230
[Incorrect Config] CFF .....	230
[Invalid Config] CFI .....	230
[Conf Transfer Error] CFI2 .....	231
[Control Supply Error] CLF .....	231
[Cust Supply Error] CPSF.....	231
[Ctrl Memory Error] EEF1.....	232
[Pwr Memory Error] EEF2 .....	232
[External Error] EPF1.....	232
[Fan Feedback Error] FFDF .....	233
[Mains Freq Error] FRF .....	233
[FW Update Error] FWER.....	233
[No Power Comm Error] FWMC .....	234
[Fware Pairing Err] FWPF.....	234
[Internal Link Error] ILF .....	234
[Internal Error 1] INF1 .....	235
[Internal Error 3] INF3 .....	235
[Internal Error 4] INF4 .....	235
[Safety CPU error] INF5 .....	235
[Internal Error 8] INF8 .....	236
[Internal Error 11] INF8 .....	236
[Internal Error 14] INFE .....	236
[Internal Error 15] INFF .....	236
[Internal Error 21] INFL .....	237
[Internal Error 25] INFP .....	237
[Internal Error 26] INFQ .....	237
[Internal Error 35] INFZ .....	237
[Input Contact. Closed] LCCE .....	238
[Input Contactor] LCF .....	238
[Mains Direction Error] MDDE .....	238
[Mains Nom. Volt. Error] NOSF.....	239
[Overcurrent] OCF .....	239
[Device Overheat] OHF .....	239
[Process Overload] OLC.....	240
[Motor Overload] OLF .....	240
[Output Phase Loss] OPF.....	240
[Supply Mains OverV] OSF .....	240
[Input Phase Loss] PHF.....	241
[Phase Inversion] PIF .....	241
[Ground Short Circuit] SCF3 .....	241
[SCR Sync Error] SDF .....	241
[Mdb Com Interrupt] SLF1 .....	242
[PC Com Interrupt] SLF2 .....	242
[HMI Com Interruption] SLF3 .....	242
[Security Files Corrupt] SPFC .....	243
[Sec Policy Update Err] SPTF .....	243
[AI1 Th Sensor Error] T1CF.....	243
[AI1 Th Level Error] TH1F.....	243
[Device Overheat] TJF .....	244
[Too Long Start Err] TLSF .....	244
[Proc Underload] ULF .....	244
[Supply Mains UnderV] USF.....	244

## Warning Messages

### List of Available Warning Messages

Any warning that is triggered and assigned to a warning group, will be :

- signaled by the LED of the soft starter;
- signaled by the icon  on the graphic display terminal;
- logged in the warning history.

Access paths to assign to a warning group:

- **[Diagnostics] → [Warnings]**
- **[Complete settings] → [Error/Warn handling] → [Warn groups config]**

By default the following warnings are assigned to the **[Warn grp 1 definition]**, page 220:

- **[Low Battery Warn]**
- **[No Battery Warn]**
- **[Invalid RTC Warn]**
- **[Mains Loss Warn]**
- **[Output Phase Loss]**
- **[Static Port/Serv Warn]**
- **[Serv. Access Auth.]**
- **[ByPass Ov.Curr Warn]**

ماکان کنترول

Setting	Code	Description
[Device Th Warn]	THA	<b>Device thermal state warning</b> , see Monitor thermal measurements, page 204.
[Therm Junction Warn]	TJA	<b>Thermal junction warning</b> .
[Fan Counter Warn]	FCTA	<b>Fan counter warning</b> , see Fan diagnostic, page 216.
[Fan Fdbk Warn]	FFDA	<b>Fan feedback warning</b> , see Fan diagnostic, page 216.
[Ext. Error Warn]	EFA	<b>External error warning</b> , see Error and Warning Handling , page 218.
[UnderV Warn]	USA	<b>Undervoltage warning</b> , see Overvoltage & Undervoltage, page 128.
[Forced Run]	ERN	<b>Device in forced run</b> , see Smoke Extraction, page 148.
[Proc Undld Warn]	ULA	<b>Process underload warning</b> , see Process Underload , page 124.
[Proc Overload Warn]	OLA	<b>Process overload warning</b> , see Process Overload, page 122.
[Dev Th reached]	TAD	<b>Device thermal threshold reached</b> , see Monitor thermal measurements, page 204.
[AI1 Th Warning]	TP1A	<b>AI1 thermal sensor warning</b> , see Motor External Thermal Sensor, page 132.
[Motor Overload Warn]	OLMA	<b>Motor overload warning</b> .
[Low Battery Warn]	RBLA	Soft starter <b>Low Battery warning</b> , see Scheduled Servicing, page 246.
[No Battery Warn]	RBNA	Soft starter <b>Battery not detected warning</b> , see Scheduled Servicing, page 246.
[Invalid RTC Warn]	RTCA	<b>Invalid RTC warning</b>
[Bypass Warn]	BPA	<b>Bypass warning</b>
[Modbus Com Warn]	SLLA	<b>Modbus comm interruption warning</b> , see Modbus VP12S port configuration, page 192.
[Inhibited Errors Warn]	INH	<b>Inhibited errors warning</b> , see Smoke Extraction, page 148.
[Temp Sens AI1 Warn]	TS1A	<b>Temperature sensor AI1 warning</b> , see Motor External Thermal Sensor, page 132.
[Mains Loss Warn]	PHF	<b>Mains Loss warning</b> .
[Output Phase Loss]	OPF	<b>Output Phase Loss warning</b> , see Phase Loss, page 128.
[Bypass Cont Excess]	BPCA	<b>Recommended bypass contactor cycles exceeded</b> , the bypass contactor cycles exceeded 90% of total service life.
[Overvoltage Warn]	OSA	<b>Overvoltage warning</b> , see Overvoltage & Undervoltage, page 128.
[Volt Unbalance Warn]	ULBA	<b>Mains unbalance warning</b> , see Unbalanced Voltage & Unbalanced Current, page 131.
[Voltage Sag Warn]	SAGA	<b>Voltage sag detection warning</b> , see Monitor voltage measurements, page 201.
[Curr Unbal Warn]	ILBA	<b>Current unbalance warning</b> , see Unbalanced Voltage & Unbalanced Current, page 131.

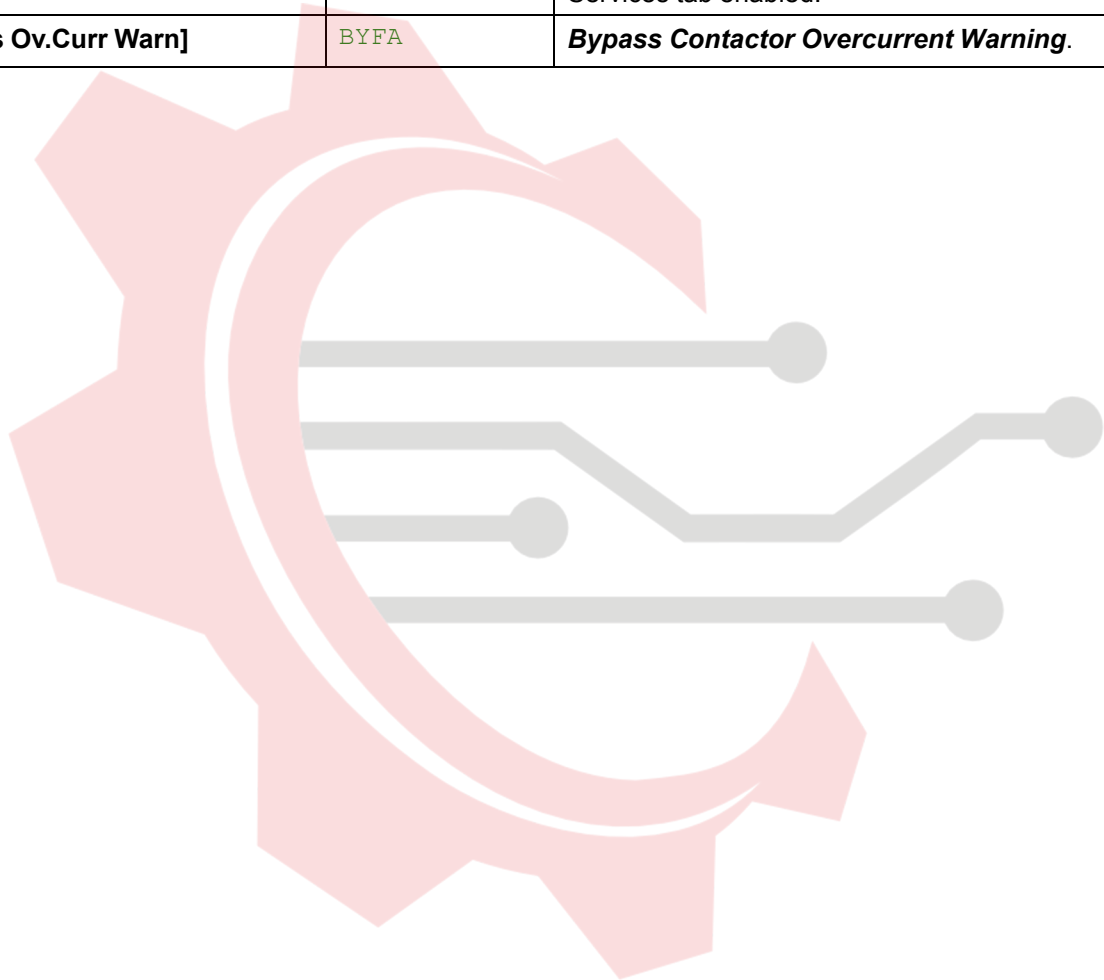

Setting	Code	Description
[Mains Freq Warn]	FRQA	<b>Mains frequency warning</b> , see Mains Frequency, page 135.
[Config Recover Warn]	CBRA	<b>Configuration recovery warning</b> , see .
[Sys. Log. Warning]	SLGA	<b>System Log Warning</b> , application and log limits is almost reached (or reached), logs must be downloaded. See Security Event Logging, page 221.
[Serv. Access Auth.]	SMSA	<b>After-Services Access Authorized</b> , After Sales Services tab enabled.
[ByPass Ov.Curr Warn]	BYFA	<b>Bypass Contactor Overcurrent Warning</b> .



ماکان کنترول



## [Line Short Circuit] BYF1

### *Internal line short circuit error*

 Probable Cause	Bypass contactor is closed or SCR is short circuited.
 Remedy	Contact your local Schneider Electric representative.
 Clearing the Error Code	This detected error requires a power reset.



## [Bypass Closing Error] BYF2

### *Bypass contactor error when closing*

 Probable Cause	Bypass relay blocked in opened state.
 Remedy	Contact your local Schneider Electric representative.
 Clearing the Error Code	This detected error requires a power reset.



## [Bypass Open Error] BYF3

### *Bypass contactor error when opening*

 Probable Cause	Bypass unwanted open error.
 Remedy	Contact your local Schneider Electric representative.
 Clearing the Error Code	This detected error requires a power reset.



## [ByPass Overcurrent] BYF4

### Bypass Contactor Overcurrent

 Probable Cause	<ul style="list-style-type: none"> <li>This error is triggered only when the soft starter is bypassed and the motor current is over 2 times the soft starter rated current.</li> <li>Load too high (mechanical locking).</li> </ul> <p>In case of multiple <b>[ByPass Overcurrent] BYF4</b> or <b>[Overcurrent] OCF</b> errors triggered, the internal bypass relays may be damaged, leading to relays being stuck.</p>
 Remedy	<ul style="list-style-type: none"> <li>Check the size of the motor/device/load.</li> <li>Check the stability of the application.</li> <li>Contact your local Schneider Electric representative.</li> </ul>
 Clearing the Error Code	<p>This detected error requires a power reset.</p>



## [Incorrect Config] CFF

### Incorrect configuration

 Probable Cause	<ul style="list-style-type: none"> <li>Option module has been changed for another fieldbus or removed.</li> <li>Control block replaced by a control block configured on a soft starter with a different rating.</li> <li>The current configuration is inconsistent.</li> </ul>
 Remedy	<ul style="list-style-type: none"> <li>Verify that the option module or the product are not damaged.</li> <li>In the event of the control block being changed deliberately, see the remarks below.</li> <li>Press the <b>OK</b> key to validate the message displayed on the display terminal. This action will set a return to factory settings.</li> <li>Or retrieve the backup configuration if it is valid.</li> </ul>
 Clearing the Error Code	<p>This detected error is cleared as soon as its cause has been removed.</p>



## [Invalid Config] CFI

### Invalid configuration

 Probable Cause	<p>Inconsistent, invalid, unauthorized or out-of-bound value written to a parameter via a fieldbus or communication link. The written value is rejected, the previous one is kept and this error is triggered.</p>
 Remedy	<p>This error is automatically cleared after:</p> <ul style="list-style-type: none"> <li>Writing a correct value on any parameters via communication or fieldbus link.</li> <li>Writing a correct value on any parameters via any HMI (display terminal, SoMove...).</li> <li>Reset to factory settings, new configuration transfer or configuration restoration.</li> </ul>
 Clearing the Error Code	<p>This detected error is cleared as soon as its cause has been removed.</p>



## [Conf Transfer Error] CF12

### Configuration transfer error

 Probable Cause	<ul style="list-style-type: none"> <li>The configuration transfer to the soft starter was not successful or interrupted.</li> <li>The configuration loaded is not compatible with the soft starter.</li> </ul>
 Remedy	<ul style="list-style-type: none"> <li>Verify the configuration loaded previously</li> <li>Load a compatible configuration</li> <li>Use a PC software commissioning tool to transfer a compatible configuration</li> <li>Perform a factory setting</li> </ul> <p><b>NOTE:</b> When this error is triggered, the current security configuration is kept valid and applied.</p>
 Clearing the Error Code	<p>This detected error is cleared as soon as its cause has been removed.</p>



## [Control Supply Error] CLF

### Control supply error

 Probable Cause	<ul style="list-style-type: none"> <li>Loss of control power supply on A1 and A2 terminals.</li> <li>Control power supply out of bounds.</li> </ul>
 Remedy	<ul style="list-style-type: none"> <li>Verify the control supply is wired on the terminals A1 and A2.</li> <li>In the case of an external +24V power supply, check the presence of the control supply voltage of terminals A1 and A2. It must be 110...230 Vac +10% – 15%.</li> <li>In the case of an external +24V power supply, to prevent this error from triggering, disable the monitoring of A1 / A2 power supply loss by setting <b>[Control Supply Loss]</b> in the menu <b>[Complete settings] → [Error/Warn handling]</b> to <b>[Warning]</b>. This will instead triggers the warning <b>[Ctrl Supply Loss]</b> <b>CLA</b> without blocking the device.</li> </ul>
 Clearing the Error Code	<p>This detected error can be cleared with the <b>[Auto Fault Reset]</b> or manually with the <b>[Fault Reset Assign]</b> parameter after its cause has been removed.</p>



## [Cust Supply Error] CPSE

### Customer supply error

 Probable Cause	<p>The error is triggered if the external 24VDC supply voltage is higher than the maximum DC voltage 30V, or lower than the minimum DC voltage 19V</p> <ul style="list-style-type: none"> <li>The external supply is not operating correctly.</li> <li>The +24V terminal consumption has been greater than 200mA</li> </ul>
 Remedy	<ul style="list-style-type: none"> <li>Verify the external 24VDC supply applied on the +24 terminal.</li> <li>Verify the current on the +24 terminal.</li> <li>Verify there is no short circuit between 0 and +24 terminal.</li> <li>Check the value of the <b>[Cust Supply Diag]</b> parameter:                     <ul style="list-style-type: none"> <li>Value = 0x00 : No power supply error detected since startup</li> <li>Value = 0x11 : Overcurrent detected on customer 24V supply</li> <li>Value = 0x21 : Overvoltage detected on customer 24V supply</li> <li>Value = 0x31 : Too many short undervoltages detected on customer 24V supply</li> </ul> </li> <li>Contact your local Schneider Electric representative.</li> </ul>
 Clearing the Error Code	<p>This detected error requires a power reset of the device after its cause has been removed.</p>



## [Ctrl Memory Error] EEF1

### Control memory error

 Probable Cause	An error of the internal memory of the control block has been detected.
 Remedy	<ul style="list-style-type: none"> <li>• Verify the environment (electromagnetic compatibility).</li> <li>• Do a power cycle.</li> <li>• Return to factory settings.</li> <li>• Contact your local Schneider Electric representative.</li> </ul>
 Clearing the Error Code	This detected error requires a power reset of the device after its cause has been removed.



## [Pwr Memory Error] EEF2

### Power memory error

 Probable Cause	An error of the internal memory of the power board has been detected.
 Remedy	<ul style="list-style-type: none"> <li>• Verify the environment (electromagnetic compatibility).</li> <li>• Do a power cycle.</li> <li>• Return to factory settings.</li> <li>• Contact your local Schneider Electric representative.</li> </ul>
 Clearing the Error Code	This detected error requires a power reset of the device after its cause has been removed.



## [External Error] EPF1

### External detected error

 Probable Cause	<ul style="list-style-type: none"> <li>• Error raised based on <b>[Ext Error assign]</b> configuration via <b>[DI•]</b> or <b>[CD••]</b>.</li> <li>• Duplicate or invalid IP address.</li> </ul>
 Remedy	Remove the cause of the external error.
 Clearing the Error Code	This detected error can be cleared manually with the <b>[Fault Reset Assign]</b> parameter after its cause has been removed.



## [Fan Feedback Error] F'FDF'

### Fan feedback error

	Probable Cause	The <b>[Fan Feedback Error]</b> is trigger when the fan speed feedback is lower than the threshold of the minimum fan speed for at least 5s.
	Remedy	<ul style="list-style-type: none"> <li>• Check the state of the fan.</li> <li>• Change the fan if the fan is in bad state.</li> </ul>
	Clearing the Error Code	This detected error requires a power reset of the device after its cause has been removed.





## [Mains Freq Error] F'RF'

### Mains frequency out of tolerance

	Probable Cause	<ul style="list-style-type: none"> <li>• Mains supply frequency out of the tolerance 50 / 60 Hz</li> <li>• Detected mains frequency at motor start different from the expected value set in <b>[Mains Frequency] FRC</b></li> </ul>
	Remedy	<ul style="list-style-type: none"> <li>• Verify the mains supply frequency respect the tolerance 50...60 Hz, +/-5% (47,5...63 Hz)</li> <li>• Verify the expected mains supply frequency set in <b>[Complete settings] CST</b> → <b>[Motor parameters] MPA</b> → <b>[Mains Frequency] FRC</b> correspond to the frequency of your mains supply.</li> </ul>
	Clearing the Error Code	This detected error can be cleared with the <b>[Auto Fault Reset]</b> or manually with the <b>[Fault Reset Assign]</b> parameter after its cause has been removed.



## [FW Update Error] F'WER'

### Firmware Update error

	Probable Cause	Firmware update function has detected an error.
	Remedy	<ol style="list-style-type: none"> <li>1.  In the menu <b>[Device Management] DMT</b> → <b>[Firmware update] FWUP</b> scroll to the parameter <b>[Available Packages] APK</b> and clear all the package .</li> <li>2. Upload a new firmware</li> <li>3. Proceed with a new firmware update.</li> </ol> <p>For more information, refer to Soft starter firmware update, page 171.</p>
	Clearing the Error Code	This detected error is cleared as soon as its cause has been removed.



## [No Power Comm Error] FWMC

### No power communication error

 Probable Cause	<ul style="list-style-type: none"> <li>No communication with power part while A1/A2 supply is present.</li> <li>Power firmware is invalid or a hardware failure has occurred</li> </ul>
 Remedy	<ul style="list-style-type: none"> <li>Try to restore power firmware</li> <li>If the LEDs Warning/Error and COM are red and yellow, perform a power reset.</li> <li>If the problem persists, contact your local Schneider Electric representative</li> <li>Refer to Soft starter firmware update, page 171.</li> </ul>
 Clearing the Error Code	<p>This detected error is cleared as soon as its cause has been removed.</p>



## [Fware Pairing Err] FWPF

### Firmware pairing error

 Probable Cause	<p>Current firmware configuration is inconsistent.</p>
 Remedy	<ul style="list-style-type: none"> <li>Restart the product</li> <li>Perform a firmware pairing</li> <li>Update the complete firmware of the device.</li> <li>Refer to Soft starter firmware update, page 171.</li> <li>If the problem persists, contact your local Schneider Electric representative.</li> </ul>
 Clearing the Error Code	<p>This detected error is cleared as soon as its cause has been removed.</p>



## [Internal Link Error] ILF

### Internal communication interruption with option module

 Probable Cause	<p>Communication interruption between option module and the soft starter.</p>
 Remedy	<ul style="list-style-type: none"> <li>Verify the environment (electromagnetic compatibility).</li> <li>Verify that the fieldbus module is well inserted in the soft starter.</li> <li>Replace the fieldbus module with an identical fieldbus module.</li> <li>Contact your local Schneider Electric representative.</li> </ul> <p><b>NOTE:</b> it is possible to check the status of ILF through the communication with his register (ADL: 7134).</p>
 Clearing the Error Code	<p>This detected error requires a power reset of the device after its cause has been removed.</p>



## [Internal Error 1] INF1

### Internal error 1 (Rating)

 Probable Cause	The power board rating is not valid.
 Remedy	Contact your local Schneider Electric representative.
 Clearing the Error Code	This detected error requires a power reset of the device after its cause has been removed.



## [Internal Error 3] INF3

### Internal error 3 (Intern Comm)

 Probable Cause	Internal communication detected error
 Remedy	Contact your local Schneider Electric representative.
 Clearing the Error Code	This detected error requires a power reset of the device after its cause has been removed.



## [Internal Error 4] INF4

### Internal error 4 (Manufacturing)

 Probable Cause	Internal data inconsistent.
 Remedy	Contact your local Schneider Electric representative
 Clearing the Error Code	This detected error requires a power reset of the device after its cause has been removed.



## [Safety CPU error] INF5

### Safety CPU error

 Probable Cause	Low level power control CPU error.
 Remedy	Reset the device or contact your local Schneider Electric representative.
 Clearing the Error Code	This detected error requires a power reset of the device after its cause has been removed.



## [Internal Error 8] INF8

### Internal error 8 (Switching Supply)

 Probable Cause	The internal power switching supply is not correct.
 Remedy	<ul style="list-style-type: none"> <li>• Check the supplies of the installation.</li> <li>• Contact your local Schneider Electric representative.</li> </ul>
 Clearing the Error Code	This detected error requires a power reset of the device after its cause has been removed.



## [Internal Error 11] INF11

### Internal error 11 (Temperature)

 Probable Cause	<p>Internal temperature sensors are monitored for short circuit or open circuit.</p> <p>If a short circuit / open circuit is detected, the INF11 error is triggered.</p> <p>The internal device thermal sensor is not operating correctly.</p>
 Remedy	Contact your local Schneider Electric representative.
 Clearing the Error Code	This detected error can be cleared with the <b>[Auto Fault Reset]</b> or manually with the <b>[Fault Reset Assign]</b> parameter after its cause has been removed.



## [Internal Error 14] INF14

### Internal error 14 (CPU)



 Probable Cause	Internal microprocessor detected error.
 Remedy	<ul style="list-style-type: none"> <li>• Verify that the error code can be cleared with a power reset.</li> <li>• Contact your local Schneider Electric representative.</li> </ul>
 Clearing the Error Code	This detected error requires a power reset of the device after its cause has been removed.

## [Internal Error 15] INF15



### Internal error 15 (Flash)

 Probable Cause	Serial memory flash format error.
 Remedy	Contact your local Schneider Electric representative.
 Clearing the Error Code	This detected error requires a power reset of the device after its cause has been removed.



**[Internal Error 21] INFL****Internal error 21 (RTC)**

 Probable Cause	Internal Real Time Clock error. It could be a clock oscillator start error.
 Remedy	Contact your local Schneider Electric representative.
 Clearing the Error Code	This detected error requires a power reset of the device after its cause has been removed.



**[Internal Error 25] INFP****Internal error 25 (Incompatibility CB & SW)**

 Probable Cause	Incompatibility between control board hardware version and firmware version.
 Remedy	<ul style="list-style-type: none"> <li>• Update the firmware package.</li> <li>• Contact your local Schneider Electric representative</li> </ul>
 Clearing the Error Code	This detected error requires a power reset of the device after its cause has been removed.

**[Internal Error 26] INFO****Internal error 26 (thyristor cmd loss)**



 Probable Cause	Thyristor command error.
 Remedy	Contact your local Schneider Electric representative.
 Clearing the Error Code	This detected error requires a power reset of the device after its cause has been removed.

**[Internal Error 35] INFZ****Internal error 35 (Invalid firmware version)**

 Probable Cause	Invalid firmware version.
 Remedy	<ul style="list-style-type: none"> <li>• Update product firmware with an official version from EcoStruxure Automation Device Maintenance or SoMove.</li> <li>• Contact your local Schneider Electric representative.</li> </ul>
 Clearing the Error Code	This detected error is cleared as soon as its cause has been removed.



## [Input Contact. Closed] LCCE

### input contactor closed

 Probable Cause	After a <i>Stop order</i> , the device is still supplied by mains even though <b>[Mains V. time out]</b> has elapsed.
 Remedy	<ul style="list-style-type: none"> <li>• Check the contactor and its wiring.</li> <li>• Check the time out.</li> <li>• Check the Supply Mains/contactor/device connection.</li> </ul>
 Clearing the Error Code	This detected error can be cleared with the <b>[Auto Fault Reset]</b> or manually with the <b>[Fault Reset Assign]</b> parameter after its cause has been removed.



## [Input Contactor] LCF

### input contactor

 Probable Cause	The soft starter power stage is not supplied even though: <ul style="list-style-type: none"> <li>• <b>[Mains V. time out] LCT</b> time-out has elapsed.</li> <li>• The relay assigned to the contactor should be activated.</li> <li>• The line contactor should be closed.</li> </ul>
 Remedy	<ul style="list-style-type: none"> <li>• Verify the settings of the parameters in the menu <b>[Complete settings] CST</b> → <b>[Mains contactor cmd] LLC</b>.</li> <li>• Verify the line contactor is in working order and its wiring.</li> <li>• Verify the line contactor coil is wired to the soft starter output.</li> <li>• Verify the presence mains supply on the line contactor and on the soft starter power stage inputs.</li> </ul>
 Clearing the Error Code	This detected error can be cleared with the <b>[Auto Fault Reset]</b> or manually with the <b>[Fault Reset Assign]</b> parameter after its cause has been removed.

## [Mains Direction Error] MDDE

### Mains Direction Error

 Probable Cause	No mains direction detected.
 Remedy	Check the mains supply connection: at the soft starter and at others protection devices (circuit breakers, fuses, contactors).
 Clearing the Error Code	This detected error can be cleared with the <b>[Auto Fault Reset]</b> or manually with the <b>[Fault Reset Assign]</b> parameter after its cause has been removed.

## [Mains Nom. Volt. Error] NOSF

### Mains nominal overvoltage

	Probable Cause	Mains input voltage is above the defined threshold <b>[Overvoltage Thld]</b> during the time <b>[OV detection delay]</b> .
	Remedy	Check the mains voltage.
	Clearing the Error Code	This detected error can be cleared with the <b>[Auto Fault Reset]</b> or manually with the <b>[Fault Reset Assign]</b> parameter after its cause has been removed.

## [Overcurrent] OCF

### Overcurrent

	Probable Cause	<ul style="list-style-type: none"> <li>• Short circuit (motor side).</li> <li>• Parameter <b>[Boost] BST</b> is not correct (if used).</li> <li>• Load too high (Mechanical locking).</li> <li>• Internal current sensor malfunction</li> <li>• Soft starter thyristor malfunction</li> </ul> <p>If the soft starter was in <b>[Ready] RDY</b> state, it can be a short circuit between soft starter thyristor and output to motor.</p> <p>In case of multiple <b>[ByPass Overcurrent] BYF4</b> or <b>[Overcurrent] OCF</b> errors triggered, the internal bypass relays may be damaged, leading to relays being stuck.</p>
	Remedy	<ul style="list-style-type: none"> <li>• Verify if a short circuit (motor side) appears.</li> <li>• Check <b>[Boost] BST</b> configuration (if used).</li> <li>• Verify the motor.</li> <li>• Verify the size of the motor / load.</li> <li>• Verify the state of the mechanism.</li> <li>• Contact your local Schneider Electric representative.</li> </ul>
	Clearing the Error Code	This detected error requires a power reset of the device after its cause has been removed.



## [Device Overheat] OHF

### Device overheating

	Probable Cause	Normal temperature of the device exceeded.
	Remedy	<ul style="list-style-type: none"> <li>• Verify the ambient temperature, the device ventilation and the motor load. Wait for the device to cool down before restarting.</li> <li>• An excessive load can overheat the soft starter.</li> <li>• An excessive amount of starting can overheat the soft starter.</li> <li>• If the error is triggered during the ramp-up, set a more gentle start in the menu <b>[Simply start] SIM</b>.</li> </ul>
	Clearing the Error Code	This detected error can be cleared manually with the <b>[Fault Reset Assign]</b> parameter after its cause has been removed.



## [Process Overload] OLC

### Process overload

 Probable Cause	<ul style="list-style-type: none"> <li>Excessive load.</li> <li>Triggered by excessive motor current.</li> </ul>
 Remedy	<ul style="list-style-type: none"> <li>Verify and remove the cause of the overload on your process</li> <li>Verify the parameters of the <b>[Overload Threshold] LOC</b> function.</li> </ul>
 Clearing the Error Code	This detected error can be cleared with the <b>[Auto Fault Reset]</b> or manually with the <b>[Fault Reset Assign]</b> parameter after its cause has been removed.



## [Motor Overload] OLF

### Motor overload

 Probable Cause	This error is triggered when an excessive motor current has been detected.
 Remedy	<ul style="list-style-type: none"> <li>Verify the motor load. Wait for the device to cool down before restarting.</li> <li>An excessive load can overheat the motor.</li> <li>An excessive amount of starting can overheat the motor.</li> <li>Verify <b>[Motor Class] THP</b> parameter is well configured.</li> </ul>
 Clearing the Error Code	This detected error can be cleared manually with the <b>[Fault Reset Assign]</b> parameter after its cause has been removed.



## [Output Phase Loss] OPF

### Output Phase Loss error

 Probable Cause	<ul style="list-style-type: none"> <li>One or more motor phases lost.</li> <li>Defective motor or incorrect motor wiring.</li> </ul>
 Remedy	Check the motor wiring and connection. <b>NOTE:</b> <b>[Phase Loss Status]</b> can provide the status of this error.
 Clearing the Error Code	This detected error can be cleared with the <b>[Auto Fault Reset]</b> or manually with the <b>[Fault Reset Assign]</b> parameter after its cause has been removed.



## [Supply Mains OverV] OSF

### Supply mains overvoltage

 Probable Cause	Supply Mains voltage too high (+10% of the maximum product voltage range during 3s).
 Remedy	Verify the Mains voltage.
 Clearing the Error Code	This detected error can be cleared with the <b>[Auto Fault Reset]</b> or manually with the <b>[Fault Reset Assign]</b> parameter after its cause has been removed.



## [Input Phase Loss] PHF

### Input phase loss

 Probable Cause	<ul style="list-style-type: none"> <li>• Device incorrectly supplied or a tripped fused.</li> <li>• One mains input or more phases are unavailable.</li> </ul>
 Remedy	<ul style="list-style-type: none"> <li>• Verify the wiring from the mains to the device, including the tightening of the connections.</li> <li>• Verify the fuses and the power connection.</li> </ul>
 Clearing the Error Code	This detected error can be cleared with the <b>[Auto Fault Reset]</b> or manually with the <b>[Fault Reset Assign]</b> parameter after its cause has been removed.



## [Phase Inversion] PIF

### Phase inversion

 Probable Cause	<ul style="list-style-type: none"> <li>• A reverse contactor used malfunction.</li> <li>• Detected phase direction at motor start different from the expected direction set in <b>[Phase Inversion Mon] PHR</b> in the menu <b>[Monitoring] PROT</b>.</li> </ul>
 Remedy	<ul style="list-style-type: none"> <li>• Check the state, the sequence and the wiring of the reverse contactor used.</li> <li>• Verify the direction set in <b>[Phase Inversion Mon] PHR</b> in the menu <b>[Monitoring] PROT</b>.</li> <li>• Verify the direction of the mains wiring upstream the soft starter</li> <li>• Invert two mains phases upstream the soft starter.</li> </ul>
 Clearing the Error Code	This detected error can be cleared with the <b>[Auto Fault Reset]</b> or manually with the <b>[Fault Reset Assign]</b> parameter after its cause has been removed.



## [Ground Short Circuit] SCF3

### Ground short circuit

 Probable Cause	Significant ground leakage current at the device output.
 Remedy	Verify the cables connecting the soft starter to the motor and the motor insulation.
 Clearing the Error Code	This detected error requires a power reset of the device after its cause has been removed.



## [SCR Sync Error] SDF

### SCR Command Synchronisation Error

 Probable Cause	Unbalance phase during acceleration and deceleration.
 Remedy	Verify the motor supply connection.
 Clearing the Error Code	This detected error can be cleared with the <b>[Auto Fault Reset]</b> or manually with the <b>[Fault Reset Assign]</b> parameter after its cause has been removed.



## [Mdb Com Interrupt] SLF1

### Modbus communication interruption

 Probable Cause	Communication interruption on the Modbus port.
 Remedy	<ul style="list-style-type: none"> <li>• Verify the communication bus.</li> <li>• Verify the timeout.</li> <li>• Refer to the Modbus communication manual.</li> </ul>
 Clearing the Error Code	This detected error can be cleared manually with the <b>[Fault Reset Assign]</b> parameter after its cause has been removed.



## [PC Com Interrupt] SLF2

### PC communication interruption

 Probable Cause	Communication interruption with the commissioning software.
 Remedy	<ul style="list-style-type: none"> <li>• Verify the commissioning software connecting cable.</li> <li>• Verify the timeout.</li> </ul>
 Clearing the Error Code	This detected error can be cleared with the <b>[Auto Fault Reset]</b> or manually with the <b>[Fault Reset Assign]</b> parameter after its cause has been removed.



## [HMI Com Interruption] SLF3

### HMI communication interruption

 Probable Cause	<p>Communication interruption with the display terminal.</p> <p>This error is triggered when the command value is given using the Display Terminal and if the communication is interrupted during more than 2 seconds.</p> <p><b>NOTE:</b> When this error is triggered, the active HMI becomes automatically the Embedded Display Terminal.</p>
 Remedy	<ul style="list-style-type: none"> <li>• Verify the display terminal connection.</li> <li>• Verify the timeout.</li> </ul>
 Clearing the Error Code	This detected error can be cleared with the <b>[Auto Fault Reset]</b> or manually with the <b>[Fault Reset Assign]</b> parameter after its cause has been removed.



## [Security Files Corrupt] SPFC

### Security files corrupt

 Probable Cause	Security file corrupted or missing.
 Remedy	<ul style="list-style-type: none"> <li>Connect a display terminal to your device, if not already connected. The error code is displayed. Press <b>OK</b> and select a cybersecurity profile. Refer to Go to product by setting cybersecurity policy (advanced, minimum), page 102</li> </ul>
 Clearing the Error Code	This detected error is cleared as soon as its cause has been removed.



## [Sec Policy Update Err] SPTF

### Security policy update error

 Probable Cause	Security policy transfer error, invalid security configuration.
 Remedy	<ul style="list-style-type: none"> <li>Check the security policy to transfer and transfer it again.</li> <li>Check the connection.</li> </ul>
 Clearing the Error Code	This detected error is cleared as soon as its cause has been removed.



## [AI1 Th Sensor Error] T1CF

### Thermal sensor error on AI1

 Probable Cause	<p>The thermal monitoring function has detected an error of the thermal sensor connected to the analog input AI1:</p> <ul style="list-style-type: none"> <li>Open circuit or short circuit</li> </ul>
 Remedy	<ul style="list-style-type: none"> <li>Verify the sensor and its wiring.</li> <li>Replace the sensor.</li> </ul>
 Clearing the Error Code	This detected error can be cleared with the <b>[Auto Fault Reset]</b> or manually with the <b>[Fault Reset Assign]</b> parameter after its cause has been removed.



## [AI1 Th Level Error] TH1F

### AI1 thermal level error

 Probable Cause	The thermal sensor monitoring function has detected a high temperature on the thermal sensor connected to the analog input AI1.
 Remedy	<ul style="list-style-type: none"> <li>Search for a possible cause of overheating.</li> <li>Verify the settings of the monitoring function.</li> </ul>
 Clearing the Error Code	This detected error can be cleared with the <b>[Auto Fault Reset]</b> or manually with the <b>[Fault Reset Assign]</b> parameter after its cause has been removed.



## [Device Overheat] T JF

### Device overheating

 Probable Cause	The thermal junction monitoring function helps to prevent the thyristors from junction over temperature.
 Remedy	<ul style="list-style-type: none"> <li>• Verify the size of the load/motor/device according to environment conditions.</li> <li>• Verify the device ventilation and the ambient temperature.</li> </ul>
 Clearing the Error Code	This detected error can be cleared manually with the <b>[Fault Reset Assign]</b> parameter after its cause has been removed.



## [Too Long Start Err] T LSF

### Too long start error

 Probable Cause	<b>[Too Long Start]</b> T L S is elapsed before meeting end of start conditions.
 Remedy	<ul style="list-style-type: none"> <li>• Search for a mechanical jam blocking the motor.</li> <li>• Search for a possible cause of motor overload.</li> <li>• Verify the start profile in the <b>[Simply Start]</b> SYS menu.</li> <li>• Verify the value set to <b>[Too Long Start Err]</b> T L S F.</li> </ul>
 Clearing the Error Code	This detected error can be cleared manually with the <b>[Fault Reset Assign]</b> parameter after its cause has been removed.



## [Proc Underload] U L F

### Process underload

 Probable Cause	Load too low.
 Remedy	<ul style="list-style-type: none"> <li>• Verify and remove the cause of the underload.</li> <li>• Verify the parameters of the <b>[Process underload]</b> U L D function.</li> </ul>
 Clearing the Error Code	This detected error can be cleared with the <b>[Auto Fault Reset]</b> or manually with the <b>[Fault Reset Assign]</b> parameter after its cause has been removed.

## [Supply Mains UnderV] U S F

### Supply mains undervoltage

 Probable Cause	<ul style="list-style-type: none"> <li>• Incorrect supply mains voltage.</li> <li>• Important voltage dip</li> </ul>
 Remedy	<ul style="list-style-type: none"> <li>• Verify the mains supply.</li> <li>• Verify the value set to <b>[Mains Voltage]</b> U L N.</li> </ul>
 Clearing the Error Code	This detected error can be cleared with the <b>[Auto Fault Reset]</b> or manually with the <b>[Fault Reset Assign]</b> parameter after its cause has been removed.

# Maintenance

## What's in This Part

Scheduled Servicing.....	246
Real Time Clock (RTC).....	251
Define a service message.....	252
Decommissioning.....	253
Additional Support.....	254



ماکان کنترول

# Scheduled Servicing

## Servicing

### **⚡⚠ DANGER**

#### **HAZARD OF ELECTRIC SHOCK, EXPLOSION OR ARC FLASH**

Read and understand the instructions in **Product Related Information** chapter before performing any procedure in this chapter.

**Failure to follow these instructions will result in death or serious injury.**

The temperature of the products described in this manual may exceed 80 °C (176 °F) during operation.

### **⚠ WARNING**

#### **HOT SURFACES**

- Ensure that any contact with hot surfaces is avoided.
- Do not allow flammable or heat-sensitive parts in the immediate vicinity of hot surfaces.
- Verify that the product has sufficiently cooled down before handling it.
- Verify that the heat dissipation is sufficient by performing a test run under maximum load conditions.

**Failure to follow these instructions can result in death, serious injury, or equipment damage.**

### **⚠ WARNING**

#### **INSUFFICIENT MAINTENANCE**

Verify that the maintenance activities described below are performed at the specified intervals.

**Failure to follow these instructions can result in death, serious injury, or equipment damage.**

Adherence to the environmental conditions must be ensured during operation of the device. In addition, during maintenance, verify and, if appropriate, correct all factors that may have an impact on the environmental conditions.

ماكان كنترول

To verify	Part concerned	Activity	Interval (1)
Overall condition	All parts such as housing, HMI, control block, connections, etc.	Perform a visual inspection	At least every year
Corrosion	Terminals, connectors, screws	Inspect and clean if required	
Dust	Terminals, fans, cabinet air inlets and air outlets, air filters of cabinet		
Cooling	Soft starter fans	Perform a visual inspection of operating fans	
		Replace the fans, see catalog and the instructions sheets on <a href="http://se.com">se.com</a>	After 3 to 5 years, depending on the operating conditions.
Fastening	All screws for electrical and mechanical connections	Verify tightening torques	At least every year
Device clock	Display terminal	Verify the displayed time and correct if required (for more information, refer to Real Time Clock (RTC), page 251)	At least every year
CR2032 device battery	On top side of the soft starter control block	Perform a visual inspection of the battery level on the display terminal	At least every year
<p>(1) Maximum maintenance intervals from the date of commissioning. Reduce the intervals between maintenance to adapt maintenance to the environmental conditions, the operating conditions of the soft starter, and to any other factor that may influence the operation and / or maintenance requirements of the soft starter.</p>			

**NOTE:** The fan operation depends on the soft starter thermal state. The soft starter may be running but not the fan.

Fans may continue to run for a certain period of time even after power to the product has been disconnected.

**⚠ CAUTION**

**RUNNING FANS**

Verify that fans have come to a complete standstill before handling them.

**Failure to follow these instructions can result in injury or equipment damage.**

## Replace the battery

HMI label	Setting	Factory setting
[Battery Level] <small>EBAL</small>	[No Battery]...100%	–
<p><b>Battery level</b>            Access path: [Device Management] → [Date &amp; Time]</p> <p>Gives embedded battery level (updated by steps of 25%):</p> <ul style="list-style-type: none"> <li>• 0%: Embedded battery is extremely low.</li> <li>• 25%: Embedded battery is low.</li> <li>• 50%-75%: Embedded battery is correct.</li> <li>• 100%: Embedded battery is full.</li> <li>• <b>[No Battery]</b> : Embedded battery is flat, damaged or not present</li> </ul> <p><b>NOTE:</b> In case of battery is empty or not present:</p> <ul style="list-style-type: none"> <li>• The device has not yet been powered off: the device runs normally, showing a warning inviting the user to change it. If the battery is replaced, time and date are lost.</li> <li>• The device has already been powered off once: the device runs normally; time and date are not valid. Warning for changing the battery is present.</li> <li>• Motor thermal monitoring: in case of powering off, the device considers the last saved thermal state.</li> </ul> <p><b>NOTE:</b> In case of A1/A2 or 24V not present, if the battery is replaced, time and date are lost. The user will have to set time and date at next power ON.</p> <p><b>NOTE:</b> Logged data will not be time stamped if battery level reached 0%.</p>		

ماکان کنترول

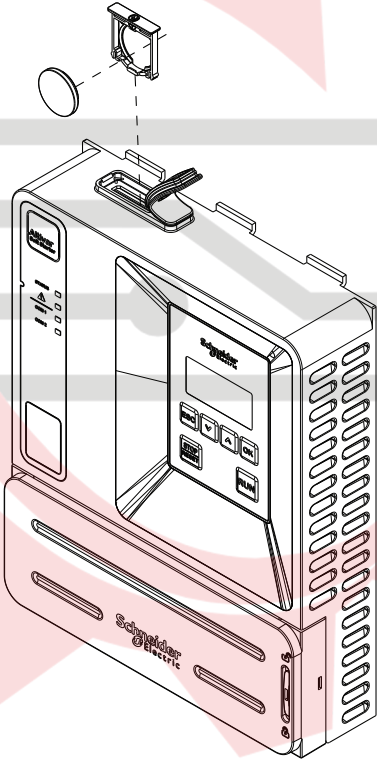
Step	Action
1	<p>Turn off your installation and remove the mains and A1/A2 supplies.</p> <p><b>Note:</b></p> <p>If the battery is empty :</p> <ul style="list-style-type: none"> <li>• Removing the mains and A1/A2 supplies will result in date and time data loss.</li> <li>• The date and time need to be set at the next power up.</li> </ul>
2	<p>Connect the +24 of the soft starter, page 38 to a +24V external source (if not already connected to an external source) and applied it to the product.</p> <p><b>Note:</b></p> <p>If the +24V is not applied or available:</p> <ul style="list-style-type: none"> <li>• During the replacement of the battery, the date and time data will be lost.</li> <li>• The date and time need to be set at the next power up.</li> </ul>
3	<p>Remove and replace the battery.</p> <p>Battery placement:</p> 
4	<p>After this operation, the +24V external source can be removed or turned off.</p>
5	<p>Connect to the mains and A1/A2 supplies and turn on your installation.</p>

## Wear Parts

Order wear parts such as:

- Control block (VX4G4301), Control block (VX4G4302)
- Fan sub assembly

Corresponding soft starter	Reference	
ATS430D88S6... ATS430C17S6	VZ3V4902	
ATS430C21S6... ATS430C41S6	1 fan kit necessary	VZ3V4903
ATS430C48S6... ATS430C59S6	3 fan kits necessary	
	VZ3V4904	

**NOTE:** reset the counter after changing the fans, refer to Fan Counter Reset, page 217.

- IP20 kit assembly:

Corresponding soft starter	Reference
ATS430C14S6, ATS430C17S6	VW3G4701
ATS430C21S6...ATS430C41S6	VW3G4702
ATS430C48S6...ATS430C59S6	VW3G4703

## Spare Parts

This product is repairable, please contact your Customer Care Center on:

[www.se.com/CCC](http://www.se.com/CCC).

ماكان كنترول

# Real Time Clock (RTC)

## Introduction

The soft starter has a real-time clock that provides the current date and time.

## Clock Accuracy

The resolution of the real-time clock is 1 ms; The clock accuracy is affected by the operating temperature of the application:

Operating temperature	Maximum yearly drift at the first year of the product	Maximum yearly drift at the second year of the product	Maximum yearly drift at the third year of the product
25 °C (77 °F) stabilized	+/- 10.52 minutes	+/- 12.1 minutes	+/- 13.67 minutes
0...60 °C (32...140 °F)	+/- 36.8 minutes	+/- 38.38 minutes	+/- 39.95 minutes

ماکان کنترول

## Define a service message

Under the **[Customization]** menu, use the **[Service Message]** menu to define up to 5 user-defined service messages.

This defined message is displayed in **[Diagnostics] → [Diag. data] → [Service Message]** submenu.



ماکان کنترول

# Decommissioning

## Uninstalling the Product

Observe the following procedure when uninstalling the device:

- If this device is going to be re-used in the future,
- Switch off all supply voltage. Verify that no voltage is present.

Refer to Product related information, page 9 for safety-related instructions.

- Remove all connection cables.
- Uninstall the product.

## End of Life

The components of the product consist of different materials which can be recycled and which must be disposed of separately.

- Dispose of the packaging in compliance with all applicable regulations.
- Dispose of the product in compliance with all applicable regulations.

Refer to the **Environmental Data Program** for information and documents on environmental protection such as EoLI (End of Life Instruction).

You can download RoHS and REACH compliance declarations, Product Environmental Profiles (PEP) and End-of-Life instructions (EoLi).

ماکان کنترول

## Additional Support

### Electronic product data sheet

Scan the QR code in front of the soft starter to get the product data sheet.

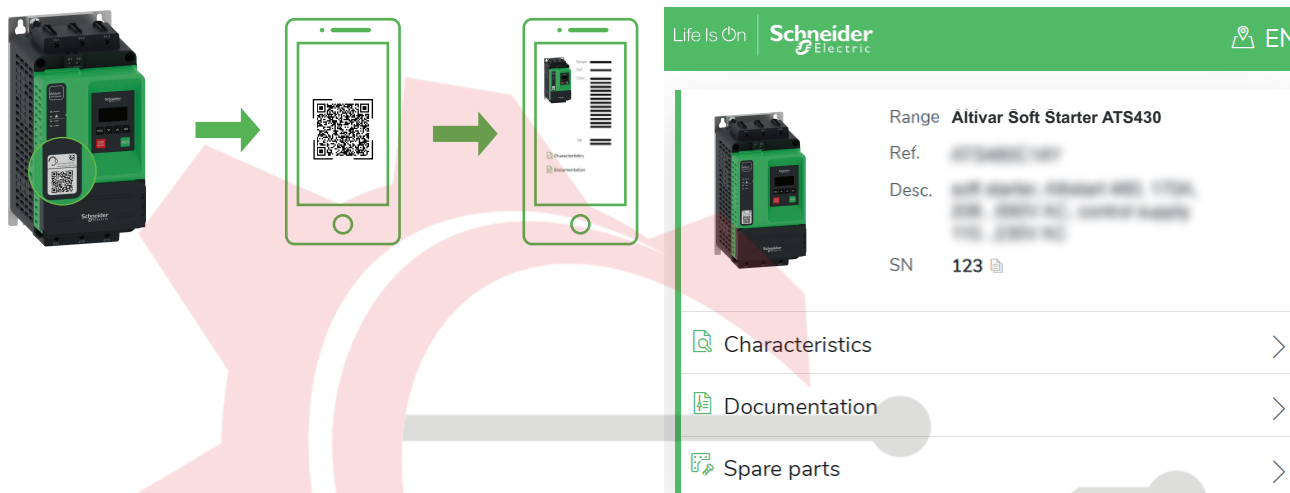

Scanning the QR Code gives you access to :

- Product ID Card : Product range, Reference, short description and a Serial Number (Use the serial number to retrieve the product's manufacturing date).  
About the Serial Number, refer to Manufacturing Date, page 255.
- The product characteristics : Main characteristics, environment, packing units, sustainability...
- Documentation : Technical Guidance at Glance (Presentation, Dimensions, Mounting, Wiring, Commissioning...) and Product Documentation (User guide, Instructions sheets, Certificates, How To videos...)
- Spare parts for your product

ماکان کنترول

## Manufacturing Date

Use the serial number on the nameplate of the soft starter to retrieve its manufacturing date.

The four digits before the 2 characters of the serial number provide respectively the year and the week of manufacture.

In the example below HL2422110100130 the manufacturing date is year 2024, week 22.

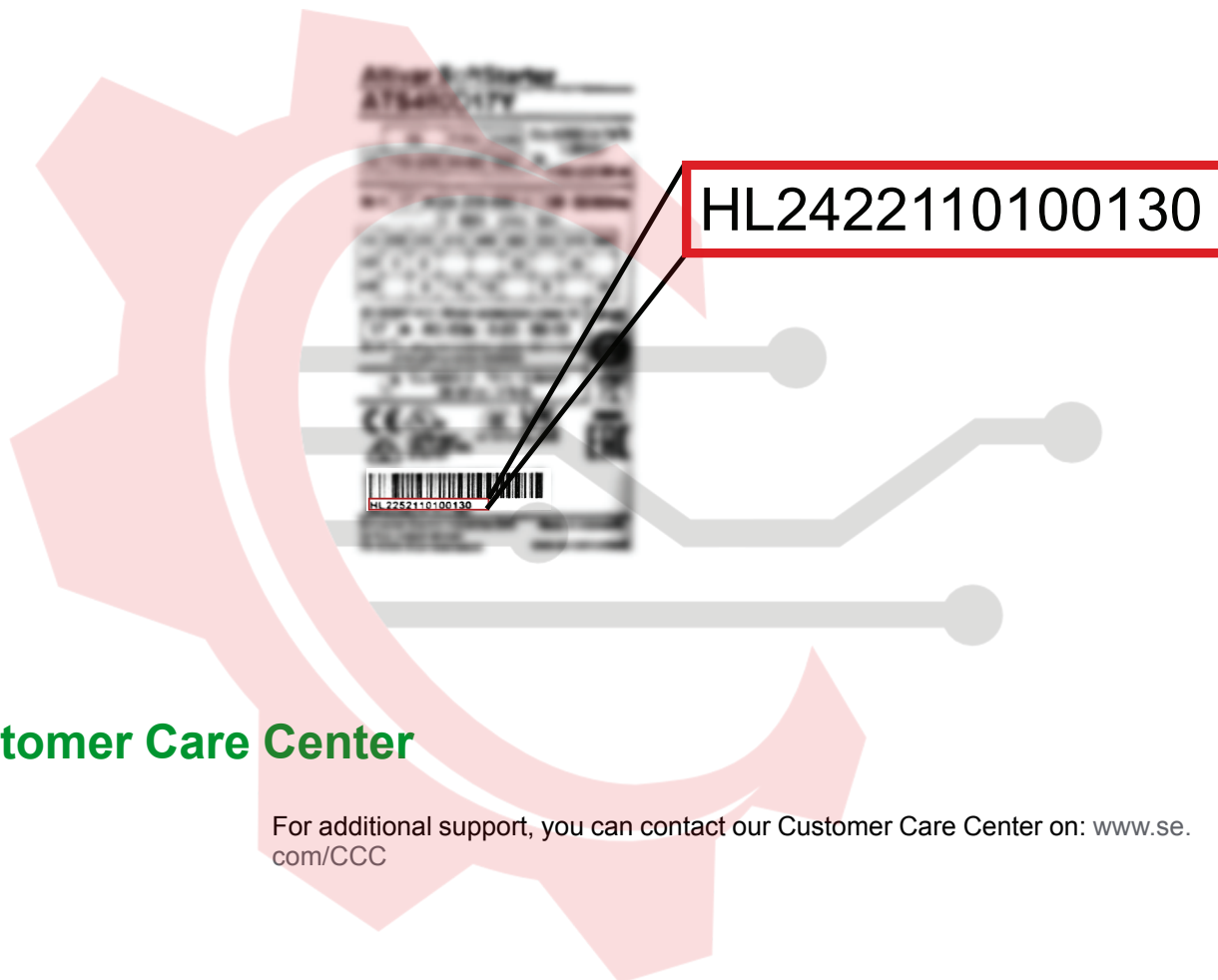

## Customer Care Center

For additional support, you can contact our Customer Care Center on: [www.se.com/CCC](http://www.se.com/CCC)

ماکان کنترول

# Annex

## What's in This Part

How to interpret and react to a NST state .....	257
How to determine which units are applicable for your soft starter? .....	258
Soft Starter State.....	259
HMI Tree Navigation.....	260

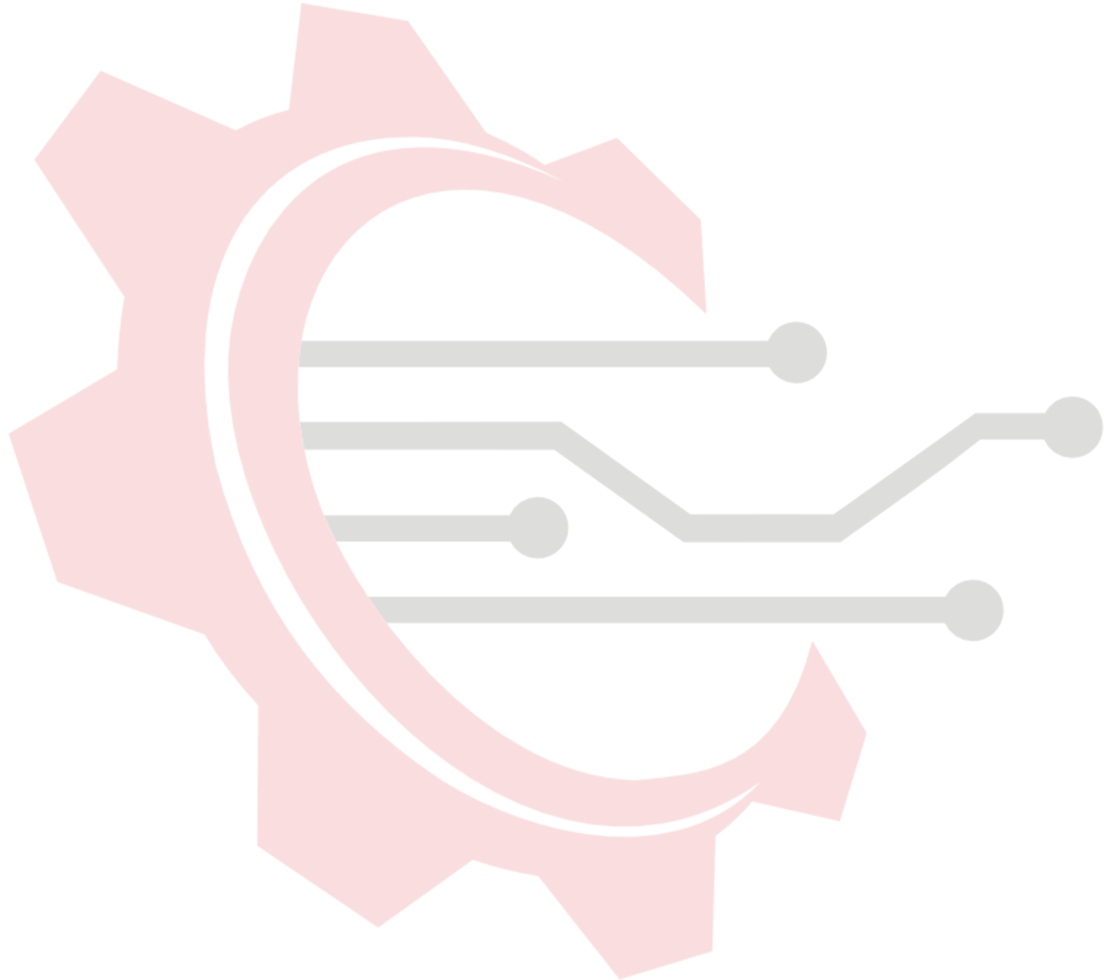

ماکان کنترل

# How to interpret and react to a NST state

## Root causes of NST state

The following table provides possible root causes of NST status. Several causes can occur at the same time.

NST state	How to move from NST
Command via fieldbus	Check the CMD value. This depends on the control profile used (STD / IO) and the channel used. Refer to the communication manuals for more information.
Run order already present	Check that the digital or virtual inputs are switched back to low level before trying a new command such as preheating.
3 wire terminal	Check that the DI1 is at high level.
<b>[Device Lock]</b> <small>LES</small>	Check that the digital or virtual input assigned to <b>[Device Lock]</b> is at the right level.
HMI Stop Key	Check the HMI Stop key is not pressed.

**NOTE:** If a Stop command is applied via a channel different from the active command channel, the NST State is displayed as long as the RUN command from the active command channel is not removed.

ماکان کنترول

## How to determine which units are applicable for your soft starter?

The unit, which depends on the size of the product, is displayed for :

Current	Electrical Motor Active Power	Electrical Motor Reactive Power	Torque
<ul style="list-style-type: none"> <li>For sizes smaller than ATS430C25S6, the unit is 0.1 A.</li> <li>For ATS430C25S6 and up, the unit is 1 A.</li> </ul>	<ul style="list-style-type: none"> <li>For sizes smaller than ATS430C25S6, the unit is 0.1 kW.</li> <li>For ATS430C25S6 and up, the unit is 1 kW.</li> </ul>	<ul style="list-style-type: none"> <li>For sizes smaller than ATS430C25S6, the unit is 0.1 kVAr.</li> <li>For ATS430C25S6 and up, the unit is 1 kVAr.</li> </ul>	<ul style="list-style-type: none"> <li>For sizes smaller than ATS430C25S6, the unit is 0.1 Nm.</li> <li>For ATS430C25S6 and up, the unit is 1 Nm.</li> </ul>

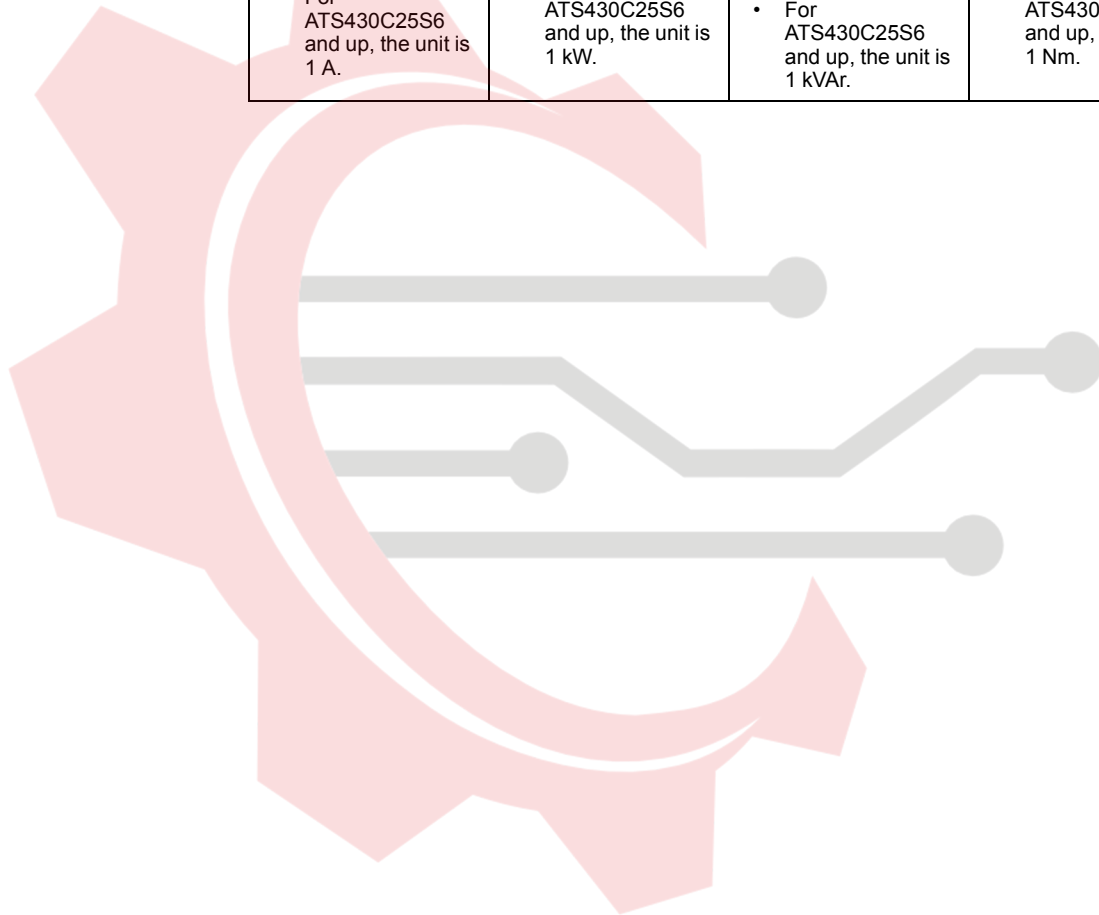

ماکان کنترول

## Soft Starter State

List of possible soft starter states, visible on the Display Terminal.

State	Condition
Displayed error label	Detected error. The soft starter is in operating state Fault.
<b>[Ready]</b> RDY	No RUN command and mains supplied.
<b>[No Mains Voltage]</b> NLP	No RUN command and mains not supplied.
<b>[Ctrl Supply Loss]</b> CLA	The warning <b>[Ctrl Supply Loss]</b> triggers when control supply is lost, the soft starter is not running and <b>[Control Supply Loss]</b> is set to <b>[Warning]</b>
<b>[Bypassed]</b> BYP	Bypass active, soft starter running.
<b>[Accelerating]</b> ACC	Soft starter in acceleration phase.
<b>[Decelerating]</b> DEC	Soft starter in deceleration phase.
<b>[Wait for Restart]</b> TBS	Starting time delay not elapsed.
<b>[Operating State "Fault"]</b> FLT	Detected error. The soft starter is in operating state Fault.
<b>[Freewheel]</b> NST	Soft starter forced to freewheel stop by serial link.
<b>[Current Limitation]</b> CLI	Soft starter in current limitation.
<b>[Motor Preheating]</b> HEA	Motor preheating, correspond to one of the following step of the preheating sequence: <ul style="list-style-type: none"> <li>• Preheating order applied but <b>[Time Before Preheat]</b> not elapsed, no preheating current injected yet</li> <li>• Preheating order applied and <b>[Time Before Preheat]</b> elapsed, preheating current is injected</li> </ul>
<b>[Small Motor Test]</b> SST	Small motor test in progress
<b>[Firmware Update]</b> FWUP	Firmware update mode

When current limitation is active, the displayed value flashes.

It is still possible to modify the parameters if the soft starter detects an error.

ماکان کنترول

# HMI Tree Navigation

## [Simply Start]

Menu	Name	Description	Settings	Factory Default Value	Chapter Reference
1.	[Simply start]		–		Simply Start, page 111
1.	[Motor Nom Current]	<i>Nominal current</i>	–	Corresponding to the usual value of a 4-pole 400 V standardized induction motor	Set The Currents, page 112
2.	[Current Limit]	<i>Motor limiting current</i>	150...700%	400% of [Motor Nom Current]	Set The Currents, page 112
3.	[Acceleration]	<i>Acceleration ramp time</i>	1...180 s	15 s	Set Start Profile, page 114
4.	[Init Starting Torque]	<i>Initial starting torque</i>	0...100 %	20%	Set Start Profile, page 114
5.	[Type of stop]	<i>Type of stop</i>	–	[Freewheel]	Set Stop Profile, page 115
6.	[Deceleration]	<i>Deceleration ramp time</i>	1...180 s	15 s	Set Stop Profile, page 115
7.	[End Of Deceleration]	<i>End of controled deceleration threshold</i>	0...100% of estimated torque when a Stop order is applied	20%	Set Stop Profile, page 115
2.	[Modified parameters]	List of the edited parameters.	–	–	-

## [Monitoring]

Menu	Name	Description	Settings	Factory Default Value	Chapter Reference
1.	[Motor Class]	<i>Motor thermal protection class</i>	–	[Class 10E]	Motor Thermal Protection Class, page 118
2.	[Underload Activation]	<i>Underload activation</i>	[Yes] or [No]	[No]	Process Underload , page 124
3.	[Unld Detect Delay]	<i>Motor underload time</i>	0...60 s	60 s	Process Underload , page 124
4.	[Underload Threshold]	<i>Underload threshold</i>	20...100% of Tn	60%	Process Underload , page 124
5.	[Underload ErrorResp]	<i>Response to underload error</i>	-	[No]	Process Underload , page 124
6.	[Underload T.B.Rest.]	<i>Unld time Before Restart</i>	0...6 min	0	Process Underload , page 124
7.	[Too Long Start]	<i>Excessive starting time</i>	10...999 seconds or [No]	[No]	Too long start, page 125
8.	[Long Start Error Resp]	<i>Response to a too long start error</i>	-	[Freewheel]	Too long start, page 125
9.	[Overload Activation]	<i>Overload activation</i>	[Yes] or [No]	[No]	Process Overload, page 122
10.	[Ovid Detection Delay]	<i>Overload detection delay</i>	0...60 s	10 s	Process Overload, page 122
11.	[Overload Threshold]	<i>Current overload threshold</i>	50...300% of [Motor Nom Current]	80 %	Process Overload, page 122

Menu	Name	Description	Settings	Factory Default Value	Chapter Reference
12.	[Overload ErrorResp]	<i>Response to overload error</i>	–	[No]	Process Overload, page 122
13.	[Overload T.B.Rest.]	<i>Ovld time Before Restart</i>	0...6 min	0	Process Overload, page 122
14.	[Phase Inversion Mon]	<i>Phase Inversion Monitoring</i>	–	[No]	Phase Inversion, page 126
15.	[Time Before Restart]	<i>Time before motor restart</i>	0...999 s	2 s	Time before restart, page 127
16.	[Phase Loss Monit]	<i>Phase loss monitoring</i>	[Yes] or [No]	[Yes]	Phase loss, page 128
17.	[Phase Loss Cur Thd]	<i>Phase loss current threshold</i>	1...10% of soft starter current rating	5%	Phase loss, page 128
18.	[Overvoltage Thld]	<i>Overvoltage threshold</i>	110...115% of <b>Mains voltage</b> ULN	110%	Overvoltage and Undervoltage, page 128
19.	[OV detection delay]	<i>Overvoltage detection delay</i>	1...10 s	2 s	Overvoltage and Undervoltage, page 128
20.	[Undervoltage Thld]	<i>Undervoltage threshold</i>	50...90% of <b>Mains voltage</b> ULN	85%	Overvoltage and Undervoltage, page 128
21.	[UV Detection Delay]	<i>Undervoltage detection delay</i>	1...60 s	5 s	Overvoltage and Undervoltage, page 128
22.	[Voltage Error Resp]	<i>Response to an under/ overvoltage error</i>	–	[No]	Overvoltage and Undervoltage, page 128
23.	[Volt Unbalance Thld]	<i>Mains unbalance threshold</i>	5...10%	5%	Unbalanced Voltage, page 131
24.	[Curr Unbalance Thld]	<i>Current unbalance alarm threshold</i>	5...60% or [No] NO	[No]	Unbalanced Current, page 131
25.	[Curr Unbalance Delay]	<i>Current unbalance alarm Delay</i>	1...60s	10s	Unbalanced Current, page 131
26.	[AI1 Th Monitoring]	<i>Activation of the thermal monitoring on AI1</i>	–	[Not Configured]	Motor External Thermal Sensor, page 132
27.	[AI1 filter]	<i>AI1 filter</i>	0...10 s	0 s	Motor External Thermal Sensor, page 132
28.	[AI1 Th Error Resp]	<i>Response to thermal error for AI1</i>	–	[Freewheel Stop]	Motor External Thermal Sensor, page 132
29.	[Gamma Sync Enable]	<i>Gamma synchronization Equilibrium Activation</i>	[Yes] or [No]	[Yes]	Gamma sync, page 133
30.	[Mot Th State Reset]	<i>Reset motor thermal state</i>	[Yes] or [No]	[No]	Motor External Thermal Sensor, page 132

## [Complete settings]

Menu	Name	Description	Settings	Factory Default Value	Chapter Reference
1.	[Motor parameters]	—	–	–	–
1.	[Motor Nom Current]	<i>Nominal current</i>	–	Corresponding to the usual value of a 4-pole 400 V standardized induction motor.	Set The Currents, page 112
2.	[Current Limit]	<i>Motor limiting current</i>	150...700%	400% of [Motor Nom Current]	Set The Currents, page 112

Menu	Name	Description	Settings	Factory Default Value	Chapter Reference
3.	[Mains Voltage]	<i>Mains voltage</i>	170...660 V	400 V	Set The Mains Voltage, page 136
	[Mains Frequency]	<i>Mains frequency</i>	–	[Auto]	Mains Frequency, page 135
2.	[Mains contactor cmd]		–	–	Mains contactor command, page 137
	[Mains Contactor]	<i>Mains contactor control</i>	[Not Assigned] or [R1] or [R2]	[Not Assigned]	Mains contactor command, page 137
	[Device Lock]	<i>Device lock assignment</i>	–	[Not Assigned]	Mains contactor command, page 137
	[Mains V. time out]	<i>Mains V. time out</i>	1...999 s	5 s	Mains contactor command, page 137
3.	[Small Motor Test]	<i>Small motor test</i>	–	[No]	Small Motor Test, page 138
4.	[Preheating]		–	–	Motor Preheating, page 143
	[Preheating Assign]	<i>Preheating assignment</i>	–	[Not Assigned]	Motor Preheating, page 143
	[Preheat Level]	<i>Preheating level</i>	5...70%	5%	Motor Preheating, page 143
	[Time Before Preheat]	<i>Time before preheat</i>	0...999 min	5 min	Motor Preheating, page 143
5.	[Start & Stop]		–	–	Start and Stop, page 142
	[Control Mode]	<i>Control mode</i>	[Torque Control] or [Voltage Control]	[Torque Control]	Torque / Voltage Control, page 142
	[Acceleration]	<i>Acceleration ramp time</i>	1...180 s	15 s	Set Start Profile, page 114
	[Init Starting Torque]	<i>Initial starting torque</i>	0...100% of nominal torque	20%	Torque / Voltage Control, page 142
	[Init Starting Voltage]	<i>Initial starting voltage</i>	25%...49% of [Mains Voltage]	49%	Torque / Voltage Control, page 142
	[Boost Assign]	<i>Boost assignment</i>	–	[Not Assigned]	Voltage Boost Level, page 150
	[Boost]	<i>Voltage boost level</i>	50...100% of the nominal motor voltage or [No]	50%	Voltage Boost Level, page 150
	[Type of stop]	<i>Type of stop</i>	–	[Freewheel Stop]	Set Stop Profile, page 115
	[Deceleration]	<i>Deceleration ramp time</i>	1...180 s	15 s	Set Stop Profile, page 115
	[Deceleration Gain]	<i>Torque control deceleration gain</i>	10...50 %	40%	Start and Stop, page 142
	[End Of Deceleration]	<i>End of controled deceleration threshold</i>	0...100% of estimated torque when a Stop order is applied	20%	Set Stop Profile, page 115
	[Torque Limit]	<i>Torque limit</i>	10...200% or [No]	[No]	Start and Stop, page 142
	[Stator Loss Comp]	<i>Stator loss compensation</i>	0...90 %	25%	Start and Stop, page 142
6.	[Smoke Extraction]		–	–	Smoke Extraction, page 148
	[Disable Error Detect]	<i>Disable error detection</i>	–	[Not Assigned]	Smoke Extraction, page 148
	[Forced Run]	<i>Forced Run</i>	–	[Disabled]	Smoke Extraction, page 148
7.	[Command channel]		–	–	Command Channel, page 152

Menu	Name	Description	Settings	Factory Default Value	Chapter Reference
1.	[Control Mode]	<i>Control mode configuration</i>	–	[Standard Profile]	Command Channel, page 152
2.	[Command Switching]	<i>Command switching</i>	–	[Cmd Channel 1]	Command Channel, page 152
3.	[Cmd channel 1]	<i>Command channel 1 assign</i>	–	[Terminals]	Command Channel, page 152
4.	[Cmd channel 2]	<i>Command channel 2 assign</i>	–	[Modbus]	Command Channel, page 152
5.	[Copy Ch1-Ch2]	<i>Copy Ch.1-Ch.2</i>	–	[No]	Command Channel, page 152
6.	[Forced Local Assign]	<i>Forced local assignment</i>	–	[No]	Command Channel, page 152
7.	[Forced Local Chan]	<i>Forced Local channel assignment</i>	–	[Terminals]	Command Channel, page 152
8.	[Time-out forc. local]	<i>Time-out forc. local</i>	0.1...30 s	10 s	Command Channel, page 152
8.	[Error/Warn handling]		–	–	Error and Warning Handling, page 218
1.	[Ext Error assign]	<i>External error assignment</i>	–	[Not Assigned]	Error and Warning Handling, page 218
2.	[Ext Error Condition]	<i>External error condition</i>	–	[High Level]	Error and Warning Handling, page 218
3.	[Ext Error Resp]	<i>Device response to external error</i>	–	[Freewheel Stop]	Error and Warning Handling, page 218
4.	[Auto Fault Reset]	<i>Automatic fault reset</i>	–	[No]	Error and Warning Handling, page 218
5.	[Fault Reset Time]	<i>Fault Reset time</i>	–	[5 minutes]	Error and Warning Handling, page 218
6.	[Disable Error Detect]	<i>Disable error detection</i>	–	[Not Assigned]	Error and Warning Handling, page 218
7.	[Forced Run]	<i>Forced Run</i>	–	[Disabled]	Error and Warning Handling, page 218
8.	[Fault Reset Assign]	<i>Fault reset input assignment</i>	–	[Not Assigned]	Error and Warning Handling, page 218
9.	[Product restart]	<i>Product restart</i>	–	[No]	Error and Warning Handling, page 218
10.	[Control Supply Loss]	<i>Response to control supply loss</i>	–	[Error]	Error and Warning Handling, page 218
11.	[Warn groups config]		–	–	Error and Warning Handling, page 218

## [Input/Output]

Menu	Name	Description	Settings	Factory Default Value	Chapter Reference
1.	[DI3 assignment]	<i>DI3 assignment</i>	–	[Freewheel Stop]	DI3 & DI4 Assignment, page 157
2.	[DI4 assignment]	<i>DI4 assignment</i>	–	[Forced Local]	DI3 & DI4 Assignment, page 157
3.	[AQ1 assignment]	<i>AQ1 assignment</i>	–	[Motor Current]	AQ1 Configuration, page 159
4.	[AQ1 Scaling]	<i>Analog output AQ1 scaling</i>	50...700 %	200 %	AQ1 Configuration, page 159

Menu	Name	Description	Settings	Factory Default Value	Chapter Reference
5.	[AQ1 Type]	<i>AQ1 Type</i>	[Voltage] or [Current]	[Current]	AQ1 Configuration, page 159
6.	[AQ1 min output]	<i>AQ1 min output value</i>	0...20 mA	0 mA	AQ1 Configuration, page 159
7.	[AQ1 max output]	<i>AQ1 max output value</i>	0...20 mA	20 mA	AQ1 Configuration, page 159
8.	[AQ1 min Output]	<i>AQ1 minimum output</i>	0...10 V	0 V	AQ1 Configuration, page 159
9.	[AQ1 max Output]	<i>AQ1 maximum output</i>	0...10 V	10 V	AQ1 Configuration, page 159
10.	[Scaling AQ1 Min]	<i>Scaling AQ1 min</i>	0...100 %	0 %	AQ1 Configuration, page 159
11.	[Scaling AQ1 Max]	<i>Scaling AQ1 max</i>	0...100 %	100 %	AQ1 Configuration, page 159
12.	[AQ1 Filter]	<i>AQ1 filter</i>	0...10 s	0 s	AQ1 Configuration, page 159
13.	[AI1 assignment]	<i>AI1 assignment</i>	[No] or [AI1 Th Monitoring]	[No]	AI1 Configuration, page 158
14.	[AI1 Type]	<i>Configuration of AI1</i>	–	[Not Configured]	AI1 Configuration, page 158
15.	[R1 Assignment]	<i>R1 assignment</i>	[Operating State Fault] or [Isolating Relay]	0 s	R1 Configuration, page 161
16.	[R2 Assignment]	<i>R2 assignment</i>	–	[Not Assigned]	R2 Configuration, page 162
17.	[R2 Delay time]	<i>R2 delay time</i>	0...60000 ms	0 ms	R2 Configuration, page 162
18.	[R2 Active at]	<i>R2 active level</i>	[High Level] or [Low Level]	[High Level]	R2 Configuration, page 162
19.	[R2 Holding time]	<i>R2 holding time</i>	0...9999 ms	0 ms	R2 Configuration, page 162

## [Communication]

Menu	Name	Description	Settings	Factory Default Value	Chapter Reference
1.	[Modbus Fieldbus]		–	–	[Modbus Fieldbus] , page 192
1.	[Modbus Address]	<i>Device modbus address</i>	[OFF]...247	[OFF]	[Modbus Fieldbus] , page 192
2.	[Modbus Baud Rate]	<i>Modbus baud rate</i>	–	[19200 bps]	[Modbus Fieldbus] , page 192
3.	[Term word order]	<i>Terminal Modbus: Word order</i>	[OFF] or [ON]	[ON]	[Modbus Fieldbus] , page 192
4.	[Modbus Format]	<i>Modbus format</i>	–	[8-E-1]	[Modbus Fieldbus] , page 192
5.	[ModbusTimeout]	<i>Modbus timeout</i>	0.1...30 s	5 s	[Modbus Fieldbus] , page 192
6.	[Modbus Error Resp]	<i>Response to Modbus interruption</i>	–	[Freewheel Stop]	[Modbus Fieldbus] , page 192
7.	[Product restart]	<i>Product restart</i>	–	[Not Assigned]	[Product restart], page 170
2.	[Modbus Terminal]		–	–	[Modbus Terminal], page 195
1.	[Modbus Address]	<i>Device modbus address</i>	[OFF]...247	[OFF]	[Modbus Fieldbus] , page 192

Menu	Name	Description	Settings	Factory Default Value	Chapter Reference
2.	[Modbus 3 baud rate]	<i>Modbus 3 baud rate</i>	–	[19200 bps]	[Modbus Terminal], page 195
	[Term 3 word order]	<i>Terminal Modbus 3: Word order</i>	[OFF] or [ON]	[ON]	[Modbus Terminal], page 195
	[Modbus 3 format]	<i>Modbus 3 format</i>	–	[8-E-1]	[Modbus Terminal], page 195
	[ModbusTimeout]	<i>Modbus timeout</i>	0.1...30 s	5 s	[Modbus Fieldbus] , page 192
	[Modbus Error Resp]	<i>Response to Modbus interruption</i>	–	[Freewheel Stop]	[Modbus Fieldbus] , page 192
	[Product restart]	<i>Product restart</i>	–	[Not Assigned]	[Product restart], page 170
	3.	[Com. scanner input]		–	–
4.	[Com. scanner output]		–	–	Refer to the fieldbus manual.
5.	[Modbus network diag]		–	–	Communication Map, page 196
	1. [Mdb Frame Nb]	<i>Mdb frame number</i>	–	–	Communication Map, page 196
	2. [Mdb CRC errors]	<i>Mdb CRC errors</i>	–	–	Communication Map, page 196
	3. [Mdb com stat]	<i>Modbus com. status</i>	–	–	Communication Map, page 196
6.	[Modbus Term Diag]		–	–	Communication Map, page 196
	1. [Mdb Term frames]	<i>Mdb TERM frames</i>	–	–	Communication Map, page 196
	2. [Mdb Term CRC errors]	<i>Mdb TERM CRC errors</i>	–	–	Communication Map, page 196
	3. [Mdb com stat]	<i>Modbus communication status</i>	–	–	Communication Map, page 196

## [Display]

Menu	Name	Description	Settings	Factory Default Value	Chapter Reference
1.	[Currents]	–	–	–	Current Parameters, page 200
	1. [Motor Current]	<i>Motor current</i>	0...(1) A (1): Max value according to soft starter rating.	–	Current Parameters, page 200
	2. [Mains Frequency]	<i>Mains frequency</i>	–	–	Current Parameters, page 200
	3. [Current RMS T1]	<i>Current RMS Phase T1</i>	0...(1) A (1): Max value according to soft starter rating.	–	Current Parameters, page 200
	4. [Current RMS T2]	<i>Current RMS Phase T2</i>	0...(1) A (1): Max value according to soft starter rating.	–	Current Parameters, page 200
	5. [Current RMS T3]	<i>Current RMS Phase T3</i>	0...(1) A	–	Current Parameters, page 200

Menu	Name	Description	Settings	Factory Default Value	Chapter Reference
			(1): Max value according to soft starter rating.		
6.	[Current Unbalance]	<i>Estimated Unbalance of the currents</i>	– 0.01...100 %	–	Current Parameters, page 200
2.	[Voltages]	–	–	–	Voltage Parameters, page 201
1.	[Mains Voltage]	<i>Mains Voltage (RMS)</i>	0...1000 V	–	Voltage Parameters, page 201
2.	[Mains Frequency]	<i>Mains frequency</i>	0...100 Hz	–	Voltage Parameters, page 201
3.	[Mains voltage phase 1-2]	<i>Mains voltage phase 1-2</i>	0...1000 V	–	Voltage Parameters, page 201
4.	[Mains voltage phase 2-3]	<i>Mains voltage phase 2-3</i>	0...1000 V	–	Voltage Parameters, page 201
5.	[Mains voltage phase 3-1]	<i>Mains voltage phase 3-1</i>	0...1000 V	–	Voltage Parameters, page 201
6.	[Mains Unbalance Ratio]	<i>Mains unbalance ratio</i>	0...100 %	–	Voltage Parameters, page 201
7.	[Voltage Sag Counter]	<i>Voltage Sag Counter</i>	0...4264967295	–	Voltage Parameters, page 201
3.	[Powers]	–	–	–	Power Parameters, page 202
1.	[Power Factor]	<i>Power factor</i>	0.00...1.00	–	Power Parameters, page 202
2.	[Device Efficiency]	<i>Device efficiency</i>	0...100 %	–	Power Parameters, page 202
3.	[Acv Elc Out Pwr in %]	<i>Active Electrical output power in %</i>	0...500 %	–	Power Parameters, page 202
4.	[Acv Elc Out Pwr in kW]	<i>Active Electrical output power in kW</i>	0...(1) kW (1): Max value according to soft starter rating.	–	Power Parameters, page 202
5.	[Peak Elec Out Power]	<i>Peak electrical output power</i>	0...65535	–	Power Parameters, page 202
6.	[Input Reactive Power]	<i>Input reactive power</i>	–3276,7...3276,7 kVAr	–	Power Parameters, page 202
4.	[Others]	–	–	–	Other Parameters, page 203
1.	[Motor Torque]	<i>Torque reference</i>	0...255 %	–	Other Parameters, page 203
2.	[Phase Direction]	<i>Detected phase direction</i>	–	–	Other Parameters, page 203
3.	[Real Start Time]	<i>Real Start Time</i>	0...1000 s	–	Other Parameters, page 203
5.	[Thermal Monitoring]	–	–	–	Motor External Thermal Sensor, page 132
1.	[Motor Therm State]	<i>Motor thermal state</i>	0...300 %	–	Motor External Thermal Sensor, page 132
2.	[Device Thermal State]	<i>Device thermal state</i>	0...200 %	–	Motor External Thermal Sensor, page 132
6.	[Counter Management]	–	–	–	Counter Management, page 205
1.	[Motor Run Time]	<i>Motor run time</i>	0...119304.6 h	0	Counter Management, page 205
2.	[Power-on time]	<i>Power-on time</i>	0...119304.6 h	0	Counter Management, page 205

Menu	Name	Description	Settings	Factory Default Value	Chapter Reference
3.	[Nb Of Starts]	<i>Number of motor starts</i>	0...4294967295	0	Counter Management, page 205
	[Bypass Life Cycle]	<i>Bypass contactor life cycle rate</i>	0...100 %	0	Counter Management, page 205
	[Counter Reset]	<i>Counter reset</i>	–	[No]	Counter Management, page 205
7.	[Other State]	–	–	–	Other States, page 206
	1. [Automatic restart]	–	–	–	Other States, page 206
	2. [Type of stop]	–	–	–	Other States, page 206
	3. [Bypass Active]	–	–	–	Other States, page 206
	4. [Steady State]	–	–	–	Other States, page 206
	5. [Wait Before Restart]	–	–	–	Other States, page 206
	6. [Small Motor Test]	–	–	–	Other States, page 206
	7. [Simu Mode Active]	–	–	–	Other States, page 206
8.	[I/O Map]	–	–	–	Input & Output Map, page 207
	1. [Digital Input Map]	–	–	–	Input & Output Map, page 207
	2. [Analog inputs image]	–	–	–	Input & Output Map, page 207
	3. [Digital Output Map]	–	–	–	Input & Output Map, page 207
	4. [Analog outputs image]	–	–	–	Input & Output Map, page 207
9.	[Energy parameters]	–	–	–	Energy parameters, page 208
	1. [Acv Elc Out Pwr in kW]	<i>Active Electrical output power in kW</i>	0...(1) kW (1): Max value depends on soft starter rating.	–	Energy parameters, page 208
	2. [Peak Elec Out Power]	<i>Peak electrical output power</i>	0...(1) kW (1): Max value depends on soft starter rating.	–	Energy parameters, page 208
	3. [Elc Energy Cons]	<i>Electrical energy consumed by the motor (TWh)</i>	0...999 TWh	–	Energy parameters, page 208
	4. [Elc Energy Cons]	<i>Electrical energy consumed by the motor (GWh)</i>	0...999 GWh	–	Energy parameters, page 208
	5. [Elc Energy Cons]	<i>Electrical energy consumed by the motor (MWh)</i>	0...999 MWh	–	Energy parameters, page 208
	6. [Elc Energy Cons]	<i>Electrical energy consumed by the motor (KWh)</i>	0...999 kWh	–	Energy parameters, page 208
	7. [Elc Energy Cons]	<i>Electrical energy consumed by the motor (Wh)</i>	0...999 Wh	–	Energy parameters, page 208
	8. [Elc Egy Today]	<i>Electrical energy consumed TODAY by the motor (KWh)</i>	0...4,294,967,295 kWh	–	Energy parameters, page 208
	9. [Elc Egy Yesterday]	<i>Electrical energy consumed YESTERDAY by the motor (KWh)</i>	0...4,294,967,295 kWh	–	Energy parameters, page 208

Menu	Name	Description	Settings	Factory Default Value	Chapter Reference
1-0.	[Reactive Energy]	<i>Electrical Input Reactive energy (TVARh)</i>	0...999 TVARh	–	Energy parameters, page 208
11.	[Reactive Energy]	<i>Electrical Input Reactive energy (GVARh)</i>	0...999 GVARh	–	Energy parameters, page 208
1-2.	[Reactive Energy]	<i>Electrical Input Reactive energy (MVARh)</i>	0...999 MVARh	–	Energy parameters, page 208
1-3.	[Reactive Energy]	<i>Electrical Input Reactive energy (KVARh)</i>	0...999 KVARh	–	Energy parameters, page 208
1-4.	[Reactive Energy]	<i>Electrical Input Reactive energy (VARh)</i>	0...999 VARh	–	Energy parameters, page 208
1-5.	[Counter Reset]	<i>Counter reset</i>	–	[No]	Counter Management, page 205

## [Diagnostics]

Menu	Name	Description	Settings	Factory Default Value	Chapter Reference
1.	[Diag. data]	–	–	–	Diagnostic Data, page 211
1.	[Last Error]	<i>Last error occurred</i>	–	–	
2.	[Last Warning]	<i>Last warning</i>	–	–	
3.	[Cust Supply Diag]	<i>Customer supply error diagnostic</i>	0...65535	–	
4.	[Service Message]	–	–	–	
5.	[LED Diagnostics]	–	–	–	
6.	[Customer Supply 24V]	<i>Customer supply 24V</i>	0...65535 V	–	
7.	[Control Supply 24V]	<i>Control supply 24V</i>	0...65535 V	–	
8.	[Control Supply 13V]	<i>Control supply 13V</i>	0...65535 V	–	
9.	[Power Supply 12V]	<i>Power Supply 12V</i>	0...65535 V	–	
10.	[Clear Error History]	<i>Clear error history</i>	–	[No]	
11.	[Phase Loss Status]	<i>Motor phases loss status</i>	–	–	
12.	[Mains Loss Status]	<i>Mains input phases loss status</i>	–	–	
13.	[Bypass Life Cycle]	<i>Bypass contactor life cycle rate</i>	0...100 %	–	
14.	[Bypass Diagnostics]	<i>Bypass diagnostics</i>	–	–	
15.	[Product restart]	<i>Product restart</i>	–	[No]	
16.	[FS Format]	–	–	–	
2.	[Error history]	–	–	–	Error History, page 213
1.	[Last Error 1] to [Last Error 15]	<i>Last error 1 to Last error 15</i>	–	–	
3.	[Warnings]	–	–	–	Warnings, page 215
1.	[Actual Warnings]	–	–	–	
2.	[Warn grp 1 definition] to [Warn grp 5 definition]	–	–	–	
3.	[Warning History]	–	–	–	
4.	[Fan diagnostic]	–	–	–	Fan diagnostic, page 216

Menu	Name	Description	Settings	Factory Default Value	Chapter Reference
1.	[Fan status]	-	-	-	
1.	[Fan status register]	<i>Fan operating status register</i>	-	-	
2.	[Fan 1 status]	<i>Fan 1 operating status</i>	-	-	
3.	[Fan 1 run time]	<i>Fan 1 operating time</i>	0...500000 h	-	
4.	[Fan 1 speed]	<i>Fan 1 operating speed</i>	0...65535 rpm	-	
5.	[Fan 2 status]	<i>Fan 2 operating status</i>	-	-	
6.	[Fan 2 run time]	<i>Fan 2 operating time</i>	0...500000 h	-	
7.	[Fan 2 speed]	<i>Fan 2 operating speed</i>	0...65535 rpm	-	
8.	[Fan Run Time Thld]	<i>Fan operating time threshold</i>	0...65535 h	0	
2.	[Fan Diagnostics test]	-	-	-	
3.	[Counter reset]	-	-	-	
1.	[Reset Fan 1 Run Time]	<i>Reset fan 1 operating time</i>	-	-	
2.	[Reset Fan 2 Run Time]	<i>Reset fan 2 operating time</i>	-	-	

## [Device Management]

Menu	Name	Description	Settings	Factory Default Value	Chapter Reference
1.	[DEVICE NAME]	-	-	-	Device name, page 198
2.	[Identification]	-	-	-	Soft starter firmware update, page 171
3.	[Save/Load]	-	-	-	
1.	[Copy From Device]	-	-	-	Save & Restore a device configuration, page 166
2.	[Copy To The Device]	-	-	-	
3.	[Save backup image]	-	-	-	Save & Restore a device image, page 167
4.	[Load backup image]	-	-	-	
5.	[Clear device]	-	-	-	
4.	[Factory settings]	-	-	-	
1.	[Config. Source]	<i>Source configuration</i>	-	[Macro Config]	Do a factory settings, page 168
2.	[Parameter group list]	-	-	-	
1.	[All]	-	-	-	
2.	[Device Configuration]	-	-	-	
3.	[Comm. menu]	-	-	-	
4.	[Display config.]	-	-	-	
3.	[Go to Factory Settings]	-	-	-	
4.	[Save Configuration]	-	-	-	
5.	[Cybersecurity]	-	-	-	Cybersecurity operating
1.	[Load security policy]	-	-	-	
2.	[Save security policy]	-	-	-	

Menu	Name	Description	Settings	Factory Default Value	Chapter Reference
3.	[Reset Password]	<i>Reset password</i>	-	-	
4.	[Default Password]	-	-	-	
6.	[Date & Time]	-	-	-	
1.	[Set Date/Time]	-	-	-	
2.	[Time Format]	<i>Time format</i>	-	[24h]	
3.	[Date Format]	<i>Date format</i>	-	[yyyy/mm/dd]	Set date and time, page 91
4.	[Battery Level]	<i>Battery level</i>	-	-	
5.	[Last Power Off Time]	<i>Last product power-off time</i>	0...4294967295 s	-	
7.	[Firmware update]	-	-	-	
1.	[Version Info]	-	-	-	
2.	[Check For Update]	-	-	-	
3.	[Available Packages]	-	-	-	
4.	[FW Upd Request]	<i>FW update operation request</i>	-	[No]	Soft starter firmware update, page 171
5.	[FW Update Status]	<i>Firmware Update Status</i>	-	-	
6.	[FW Update Error]	<i>Firmware Update error code</i>	-	-	
8.	[Clear device]	-	-	-	

## [My preferences]

Menu	Name	Description	Settings	Factory Default Value	Chapter Reference
1.	[Language]	-	-	-	Select languages, page 90
2.	[Parameter access]	-	-	-	Define Parameter visibility, page 106
1.	[Access Level]	<i>Access level</i>	-	[Standard]	
3.	[Customization]	-	-	-	
1.	[Stop Key Enable]	<i>Stop key enable</i>	-	[Stop Key Priority]	
2.	[HMI L/R cmd]	<i>HMI local/remote command</i>	-	[Disabled]	
3.	[My menu config.]	-	-	-	
1.	[Parameter Selection]	-	-	-	
2.	[Display Selection]	-	-	-	
3.	[Selected list]	-	-	-	Configure the display terminal, page 89
4.	[My menu]	-	-	-	
4.	[Display screen type]	-	-	-	
1.	[Display value type]	<i>HMI displayed value type</i>	-	[Digital]	
2.	[Parameter Selection]	-	-	-	
5.	[Param. Bar Select]	-	-	-	
6.	[Service Message]	-	-	-	
4.	[LCD settings]	-	-	-	

Menu	Name	Description	Settings	Factory Default Value	Chapter Reference
1.	[Screen Contrast]	-	-	-	
2.	[Standby]	-	-	-	
3.	[Display Terminal locked]	<i>Display terminal locked</i>	0...10 min	5 min	
4.	[Red Backlight]	<i>Red Backlight</i>	-	[Yes]	
4.	[QR code]	-	-	-	Customizable QR codes, page 97

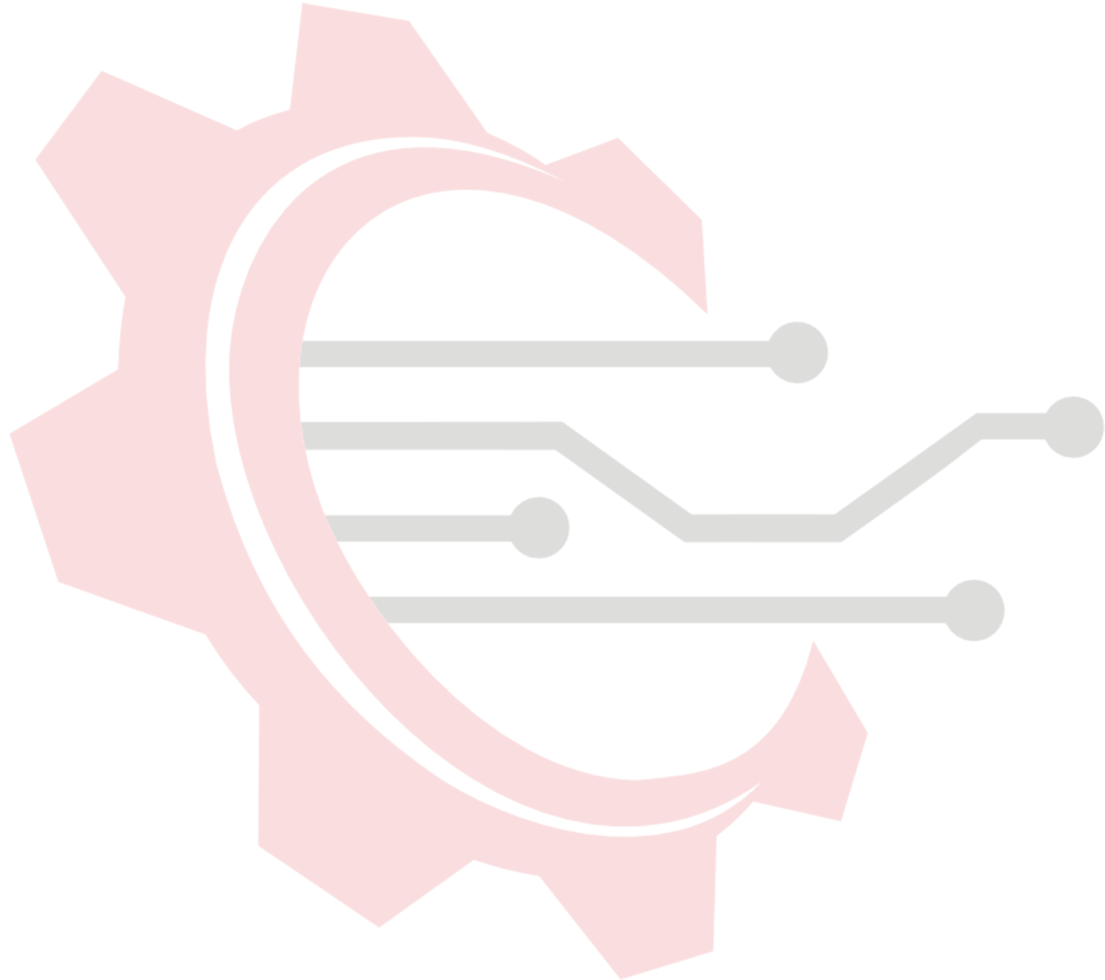

ماکان کنترول

# Glossary

## D

### Display terminal:

The Display Terminal is a local control unit plugged on the soft starter.

## E

### Error :

Discrepancy between a detected (computed, measured, or signaled) value or condition and the specified or theoretically correct value or condition.

## F

### Factory setting:

Machine status in factory settings when the product was shipped.

### Fault Reset:

A function used to restore the soft starter to an operational state after a detected error is cleared by removing the cause of the error so that the error is no longer active.

### Fault:

Fault is an operating state. If the monitoring functions detect an error, a transition to this operating state is triggered, depending on the error class. A "Fault reset" is required to exit this operating state after the cause of the detected error has been removed.

## M

### Monitoring function:

Monitoring functions acquire a value continuously or cyclically (for example, by measuring) in order to check whether it is within permissible limits. Monitoring functions are used for error detection.

## N

### NC contact:

Normally Closed contact

### NO contact:

Normally Open contact

## O

### OVCII:

Overvoltage Category II, according IEC 61800-5-1

## P

### Parameter:

Device data and values that can be read and set (to a certain extent) by the user.

### PTC:

Positive Temperature Coefficient. PTC thermistor probes integrated in the motor or application to measure its temperature

**S****SCPD:**

Short-Circuit Protective Device

**T****TVS Diode:**

Transient Voltage Suppression Diode

**W****Warning:**

If the term is used outside the context of safety instructions, a warning alerts to a potential error that was detected by a monitoring function. A warning does not cause a transition of the operating state.

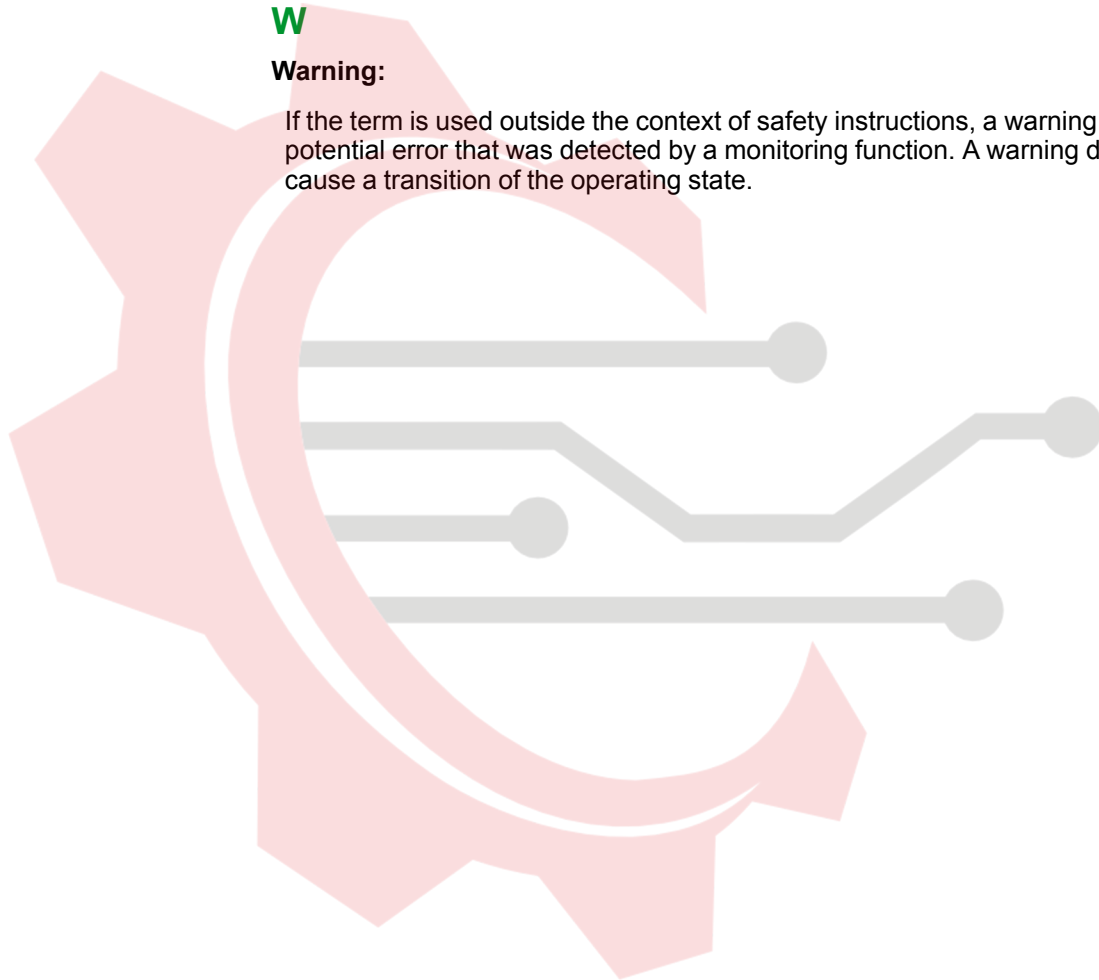

ماکان کنترول



# ماكان كنترول

Schneider Electric  
35 rue Joseph Monier  
92500 Rueil Malmaison  
France

+ 33 (0) 1 41 29 70 00

[www.se.com](http://www.se.com)

As standards, specifications, and design change from time to time, please ask for confirmation of the information given in this publication.

© 2025 – 2026 Schneider Electric. All rights reserved.

PKR63392.03– 01/2026