

# Getting Started with Altivar Soft Starter ATS430



PKR6338302

## 1 Download The ATS430 User Manual

Information below is designed to use for applications with squirrel cage induction motor and class 10 thermal protection. You must have detailed information to be able to carry out the installation and commissioning.

This information can be found in the User manual [PKR63392](#) on [www.se.com](http://www.se.com) or scan the QR code in front of the Soft Starter. The Getting Started manual does not replace the User manual. For other configurations, refer to the User Manual.



[PKR63392](#)



You can watch our Video

### **⚠️ ⚠️ DANGER**

#### HAZARD OF ELECTRIC SHOCK, EXPLOSION, OR ARC FLASH

- Only appropriately trained persons who are familiar with and fully understand the contents of the present manual and all other pertinent product documentation and who have received all necessary training to recognize and avoid hazards involved are authorized to work on and with this equipment.
- Installation, adjustment, repair and maintenance must be performed by qualified personnel.
- Verify compliance with all local and national electrical code requirements as well as all other applicable regulations with respect to grounding of all equipment.
- Only use properly rated, electrically insulated tools and measuring equipment.
- Do not touch unshielded components or terminals with voltage present.
- Prior to performing any type of work on the soft starter system, block the motor shaft to prevent rotation.
- Insulate both ends of unused conductors of the motor cable.
- Before performing work on the equipment:
  - Use all required personal protective equipment (PPE).
  - Disconnect all power, including external control power that may be present. Take into account that the circuit breaker or main switch does not de-energize all circuits.
  - Place a "Do Not Turn On" label on all power switches related to the equipment.
  - Lock all power switches in the open position.
  - Verify the absence of voltage using a properly rated voltage sensing device.
- Before applying voltage to the equipment:
  - Verify that the work has been completed and that the entire installation cannot cause hazards.
  - If the mains input terminals and the motor output terminals have been grounded and short-circuited, remove the ground and the short circuits on the mains input terminals and the motor output terminals.
  - Verify proper grounding of all equipment.
  - Verify that all protective equipment such as covers, doors, grids is installed and/or closed.

**Failure to follow these instructions will result in death or serious injury.**

Electrical equipment should be installed, operated, serviced, and maintained only by qualified personnel. No responsibility is assumed by Schneider Electric for any consequences arising out of the use of this product. © 2024 Schneider Electric. All Rights Reserved.

## 2 Verify The Delivery

Unpack the soft starter and verify that it has not been damaged.

Damaged products or accessories may cause electric shock or unanticipated equipment operation.

### **⚠️ ⚠️ DANGER**

#### HAZARD OF ELECTRIC SHOCK, EXPLOSION, OR ARC FLASH

Do not use damaged products or accessories.

**Failure to follow these instructions will result in death or serious injury.**

Contact your local Schneider Electric sales office if you detect any damage whatsoever.

Verify compatibility between your soft starter and your application.

See the ATS430 Catalog [DIA2ED2240602EN](#).



## 3 Mount ATS430 Vertically Inside an Enclosure

For a surrounding air temperature up to 40 °C (104 °F).

For other thermal conditions, see the User Manual [PKR63392](#).

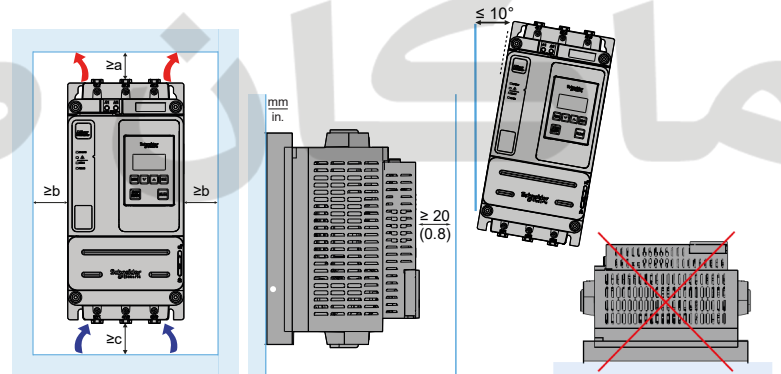

Reference	a	b	c
	mm(in)	mm(in)	mm(in)
ATS430D17S6...D47S6	100 (4)	10 (0.4)	100 (4)
ATS430D62S6...C17S6	75 (3)	10 (0.4)	60 (2.4)
ATS430C21S6...C41S6	85 (3.4)	10 (0.4)	60 (2.4)
ATS430C48S6...C59S6	100 (4)	20 (0.8)	75 (3)

## 4 Connect The Soft Starter: Power

- Wire the soft starter to the Ground  $\perp$
- Wire the motor (2/T1 – 4/T2 – 6/T3)
- Wire the supply mains (1/L1 – 3/L2 – 5/L3)
- Refer to the nameplate for tightening torque and cables section
- Stripping length: ATS430D17S6...C11S6: 17 mm (0.7 in)

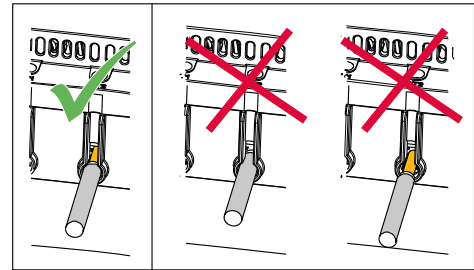

- For information on the protective and control devices, refer to the ATS430 catalog [DIA2ED2240602EN](#)

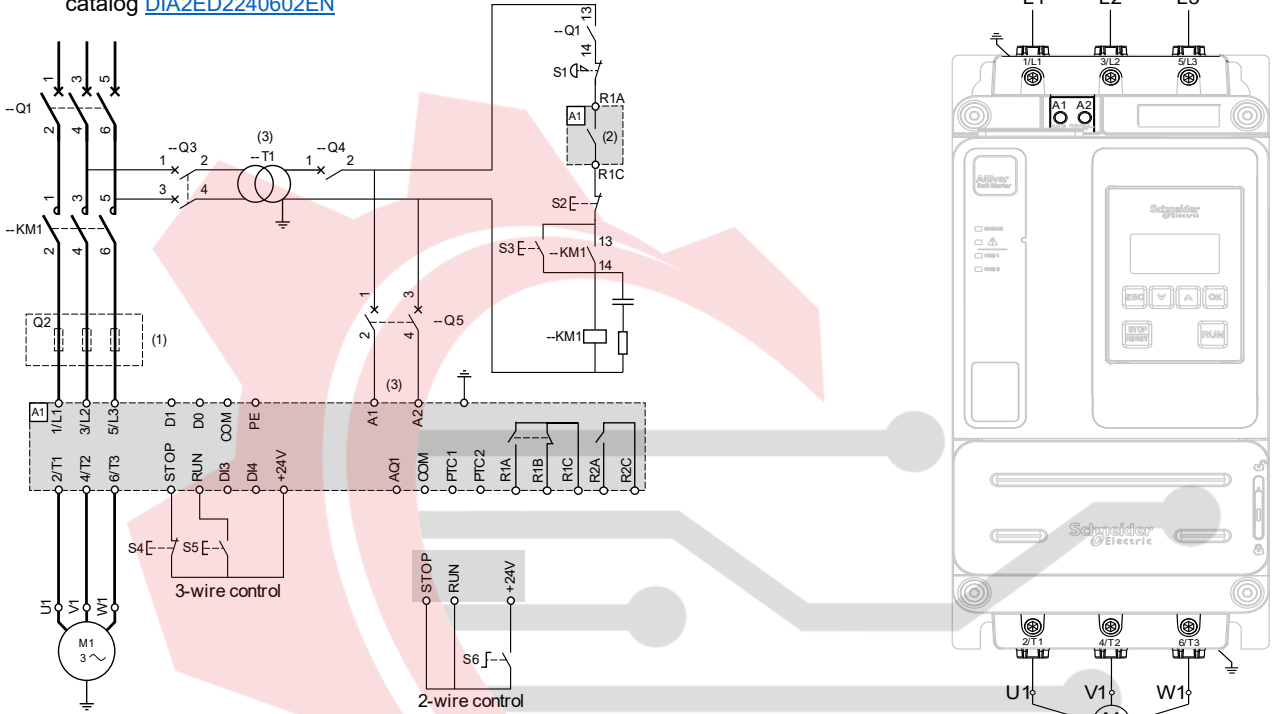

(1) Installation of additional fast-acting fuses to upgrade to type 2 coordination according to IEC 60947-4-2

(2) Relays characteristics: 250Vac / 24Vdc max

(3) The transformer "T1" must supply **110...230 Vac -15% +10%**, 50/60Hz

**KM1:** Line contactor

**Q1:** Circuit breaker. Protection of the motor

**Q2:** Fast acting fuses. Protection of the soft starter to be used only when type 2 coordination according to IEC 60947-4-2 is required. Refer to the catalog [DIA2ED2240602EN](#).

**Q3:** Circuit breaker. Protection for the primary of the transformer

**Q4:** Circuit breaker. Protection for the secondary of the transformer

**Q5:** Circuit breaker. Protection for the control part of the soft starter

**S1:** Emergency Stop push-button

**S2:** Normally close push-button. Remove supply from power section

**S3:** Normally open push-button. Power up power section

## 5 Connect The Soft Starter: Control

- Wire the control supply (A1 – A2) **110...230 Vac -15% +10%**, 50/60 Hz
- Wire the digital inputs to control the Soft Starter

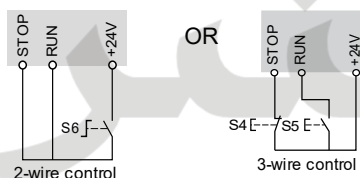

Screw type **0.5 N.m**  
4.4 lbf.in

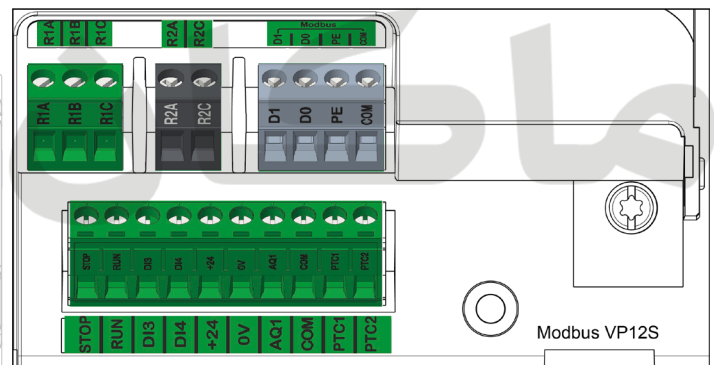
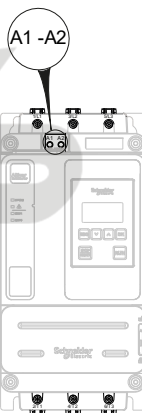

## 6 Power-up The Control Part

- Switch-on: Q1, then Q3, then Q4, then Q5.
- The soft starter turns On and displays **NLP** to indicate it is turned On and the mains supply is absent.

# Plain Text Display Terminal and LEDs: Description

- 1 ESC** Used to quit a menu/parameter or remove the currently displayed value to revert to the previous selection
- 2 OK** Used to save the current value or access the selected menu/parameter
- 3 STOP/RESET** STOP command / apply a Fault Reset (according to configuration).
- 4 RUN** RUN command (according to configuration)
- 5 Arrows** Up/down arrows are used to scroll into the menus
- 6 LEDs** Signaling LEDs

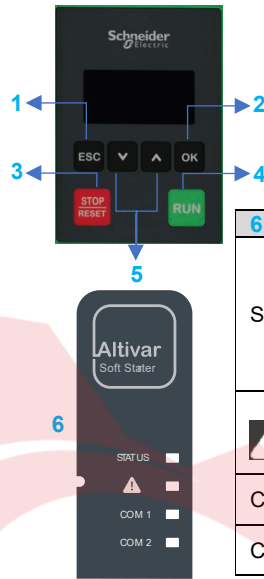

6 LED	Colour	LED status	Soft starter Status
Status	Off	Off	Powered off
	Green	Flashing	Ready to start
		Blinking	Transitory
	On	On	Bypassed
Warning (Warning icon)	Red	Flashing	SoMove communication
		On	Warning
COM 1	Yellow	Flashing	Modbus (RJ45) activity
COM 2	Yellow	Flashing	Modbus (Open-Style) activity

## 7 Initial Setup

At first power up:

- 1- In the **[LANGUAGE]** menu, select the desired language
- 2- In the **[Time Zone]** menu, set the local UTC offset. Long press **OK** to confirm
- 3- In the **[Set Date/Time]** menu, set the local time. Long press **OK** to confirm
- 4- In the **[Initial Setup]** menu, scroll to **[Go to product]** and press the **OK** button
- 5- Select **[Minimum Cybersec]** to set no credentials and access the main menu  
Or select **[Advanced Cybersec]** to set credentials then access the main menu

## 8 Simply Start

Select **[Simply Start]** menu and set parameters. Refer to the recommended values page 4.

0 [My Menu]

**1 [Simply Start]**

2 [Monitoring]

3 [Complete Settings]

...

OK

ESC

1 [Simply Start]

...

OK

ESC

Parameter	Factory Setting	Customer Setting
[Motor Nom Current]	0.4...1 of Soft Starter rating	
[Limiting Current]	400% of Motor nominal current <b>[Motor Nom Current]</b>	
[Acceleration]	15 s	
[Initial Starting Torque]	20% of nominal torque	
[Type Of Stop]	<b>[Freewheel]</b>	
If [Type Of Stop] = [Deceleration]		
[Deceleration]	15 s	
[End Of Deceleration]	20% of nominal torque	

NOTE:

The value set to **[Motor Nom Current]** determines the current of the motor thermal monitoring, depending on which motor class is set. For more information regarding the motor thermal monitoring and the selection of the motor class, refer to the menu **[Monitoring]** (User manual [PKR63392](#)).

# Recommended Values, to Adapt to Customer Requirements

Application	[Limiting Current] (% of Motor nominal current)	[Acceleration] (seconds)	[Initial Starting Torque] (% of nominal torque)	[Type Of Stop]
Centrifugal pump	450	5 to 15	0	[Deceleration]
Submersible pump	450	Up to 2	0	[Deceleration]
Piston pump	525	5 to 10	30	[Deceleration]
Fan	450	10 to 40	0	[Freewheel]
Cold compressor	450	5 to 10	30	[Deceleration]
Screw compressor	450	3 to 20	30	[Deceleration]
Centrifugal compressor	450	10 to 40	0	[Freewheel]
Piston compressor	525	5 to 10	30	[Deceleration]
Conveyor, transporter	450	3 to 10	30	[Deceleration]
Agitator	525	5 to 20	10	[Deceleration]
Mixer	525	5 to 10	50	[Deceleration]

## 9 Start And Stop The Motor

Refer to step 4 diagram.

To power up the power section, push S3

If you are in 3-wire control:

- To start the motor push S5
- To stop the motor push S4

If you are in 2-wire control:

- To start the motor close S6
- To stop the motor open S6

To remove supply from the power section, push S2

## Soft Starter Displayed Status:

Displayed Value	Condition
Error message	Triggered error, refer to the Troubleshooting below
<b>NLP</b>	Soft starter without run command and mains not supplied
<b>RDY</b>	Soft starter without run command and mains supplied
<b>BYP</b>	Soft Starter is bypassed internally
<b>RUN</b>	Soft Starter in operating transient state
<b>ACC</b>	Soft starter in acceleration phase
<b>DEC</b>	Soft starter in deceleration phase
<b>NST</b>	Soft Starter forced to freewheel stop
<b>TBS</b>	Minimum delay between one stop and one start not elapsed
<b>CLI</b>	Soft starter in current limitation. When current limitation is active, the displayed value flashes.



## Troubleshooting

Scan the QR code in front of the soft starter to get the error codes explanations in the *Diagnostics* section:

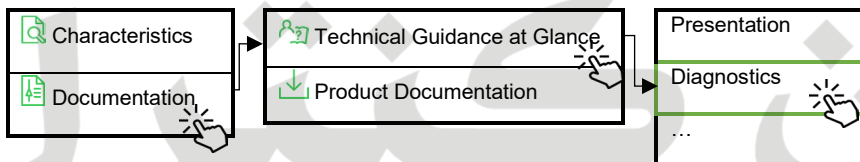

## Other Tool To Configure The Soft Starter

**SoMove** is a setup software for PC designed to configure Schneider Electric motor control devices.

You can download the SoMove FDT ([SoMove\\_FDT](#)), the DTM in English ([ATS430\\_DTM\\_Library\\_EN](#)) and language pack, on [www.se.com](http://www.se.com).